

# Cisco Compute Intersight Hardening Guide

Version 1.0

June 2024

---

# Contents

Intended use and audience	5
Bias statement	5
Legal notices	5
Prerequisites	5
Introduction	5
The Cisco Secure Development Lifecycle – CSDL	7
<b>CSDL philosophy</b>	<b>8</b>
<b>Development milestones</b>	<b>8</b>
<b>CSDL product adherence methodologies</b>	<b>9</b>
<b>Cisco Security and Trust Organization</b>	<b>9</b>
Supply-chain security	10
<b>Counterfeit prevention</b>	<b>10</b>
<b>Consortiums for secure vendors</b>	<b>11</b>
Advisories, vulnerabilities, and incident responses	12
<b>CERT advisories</b>	<b>12</b>
<b>Additional vulnerability testing measures</b>	<b>12</b>
<b>Running vulnerability scans against PVA/CVA</b>	<b>12</b>
<b>Incident response</b>	<b>12</b>
The Intersight solution	13
<b>Solution components</b>	<b>13</b>
<b>Cisco Intersight Virtual Appliance</b>	<b>13</b>
<b>Multi-Node Intersight Virtual Appliance</b>	<b>14</b>
<b>Certifications</b>	<b>14</b>
<b>CNSA (Commercial National Security Algorithm)</b>	<b>17</b>
Intersight regions	18
<b>Intersight point-of-presence replication and attack hardening</b>	<b>20</b>
Intersight privacy and data retention	21
<b>What can Cisco TAC access?</b>	<b>22</b>
<b>Data retention</b>	<b>22</b>
<b>Data backup for PVA and CVA</b>	<b>22</b>

System-level security	23
<b>System boot</b>	23
<b>Component chain of trust</b>	23
<b>Hardware root of trust - Trust Anchor Module (TAM) and Trusted Platform Module 2.0 (TPM)</b>	23
<b>Immutable identity</b>	24
<b>Runtime defenses</b>	26
<b>CPU hardware protections</b>	27
<b>Intel Boot Guard</b>	27
<b>AMD Platform Secure Boot (PSB)</b>	27
Connecting to Intersight	27
<b>Data encryption and connection security</b>	28
<b>Timeout</b>	28
<b>Target connections</b>	29
<b>Port requirements</b>	30
<b>Cisco services access requirements</b>	30
<b>Endpoint URLs required to claim targets</b>	31
<b>Configuring network ACLs in your security devices</b>	31
<b>Configuring HTTPS proxy</b>	32
<b>Default passwords</b>	32
<b>Device connector</b>	33
<b>Cisco Intersight Assist</b>	34
<b>Configure fabric interconnects for Cisco Intersight management</b>	35
<b>Multifactor claim process for fabric interconnects in the Cisco Intersight platform</b>	38
<b>Cisco Intersight Managed Mode Transition Tool</b>	40
<b>Access methods to management and configuration interfaces</b>	41
<b>Multifactor Authentication (MFA)</b>	41
<b>Single sign-on with Intersight</b>	42
<b>What management interfaces are available after IMM for FI based systems?</b>	42
<b>What interfaces are available for UCS standalone servers claimed by Intersight?</b>	42
User management	43
<b>Authentication domains</b>	43
<b>Resource groups, organizations, roles</b>	43
<b>Account types and best practices</b>	44
<b>Role-based access control</b>	44
<b>Adjusting account details</b>	45

Management at scale	46
<b>Through policy we get security enforcement</b>	<b>46</b>
<b>Server profiles and policies in Cisco UCS with Intersight</b>	<b>48</b>
<b>Firmware upgrades and image downloads</b>	<b>52</b>
<b>Upgrading fabric-interconnect firmware</b>	<b>52</b>
<b>Update server firmware</b>	<b>54</b>
<b>Intersight for API management</b>	<b>55</b>
<b>Intersight rediscovery and decommissioning</b>	<b>57</b>
<b>Securely decommissioning a system</b>	<b>59</b>
<b>Unclaim</b>	<b>60</b>
Secure application operation	61
<b>Confidential computing at the hardware level</b>	<b>61</b>
Secure data delivery and storage	62
<b>Self-Encrypting Drives (SEDs) and drive-security policy</b>	<b>62</b>
<b>Encryption and key management</b>	<b>65</b>
Monitoring with Intersight	66
<b>Endpoint syslog</b>	<b>68</b>
<b>Audit records, scope, and use cases</b>	<b>69</b>
<b>Intersight Audit Records Entries</b>	<b>69</b>
<b>Intersight Virtual Appliance monitoring</b>	<b>76</b>
<b>Intersight and PVA/CVA syslog settings</b>	<b>78</b>
Conclusions	79
For more information	79
<b>Intersight general security information</b>	<b>79</b>
<b>Additional Intersight certification information</b>	<b>79</b>
<b>Additional Intersight security guides</b>	<b>79</b>
Appendix A - Common security FAQ	80
Appendix B - PVA/CVA licensing data details	83

---

## Intended use and audience

This document contains confidential material that is proprietary to Cisco Systems, Inc. The materials, ideas, and concepts contained herein are to be used exclusively to assist in the configuration of Cisco® hardware and software solutions.

## Bias statement

The documentation set for this product strives to use bias-free language. For purposes of this documentation set, bias-free is defined as language that does not imply discrimination based on age, disability, gender, racial identity, ethnic identity, sexual orientation, socioeconomic status, and intersectionality. Exceptions may be present in the documentation due to language that is hardcoded in the user interfaces of the product software, language used based on standards documentation, or language that is used by a referenced third-party product.

## Legal notices

All information in this document is provided in confidence and shall not be published or disclosed, wholly or in part to any other party without Cisco's written permission.

## Prerequisites

We recommend reviewing the Cisco UCS® release notes, installation guide, and user guide before proceeding with any configuration. Please contact Cisco Technical Assistance Center (Cisco TAC) or your Cisco representative if you need assistance.

## Introduction

Cisco Intersight® is a Software-as-a-Service (SaaS) cloud-based infrastructure lifecycle management platform or an on-premises appliance-based device that delivers simplified deployment, monitoring, and support of a Cisco Unified Computing System™ (Cisco UCS). Systems managed with Intersight run in Intersight Managed Mode (IMM) or in standalone mode after being claimed by Intersight for management. Cisco Intersight can be used for both first-time deployment and management of UCS components and post-UCSM deployment management through a multifactor claim process.

Cisco Intersight is a cloud-operations platform that consists of modular capabilities for advanced infrastructure and workload optimization. Cisco Intersight infrastructure services include the deployment, monitoring, management, and support of your physical and virtual infrastructure. It supports Cisco Unified Computing System (Cisco UCS), myriad other Cisco networking offerings, and other third-party Intersight-connected targets. This guide is specific to UCS C-series, B-series, and X-series models.

---

This guide will focus on the security-hardening aspects of the Intersight Software-as-a-Service (SaaS) offering along with the on-premises version (Private Virtual Appliance [PVA] and Connected Virtual Appliance [CVA]) and its integration with Cisco UCS. The Cisco Intersight Connected Virtual Appliance software can be deployed on premises, allowing users to take advantage of the SaaS functionality. The Private Virtual Appliance can be deployed on premises with further security restrictions. For the remainder of this document, the term “Intersight” refers to all deployment modes unless explicitly stated otherwise.

We begin with Cisco’s development and design methodology and the various federally and internationally recognized certifications that validate this process. The guide will cover how the service is architected to secure system and service access, data transfer, and management. Regional redundancy and privacy will be explained, as well as the various user and system protections that are enabled through encryption, RBAC, segmentation, and policy.

At the core of Cisco's UCS platform and Intersight offerings lies a development philosophy centered on proactive security measures. With an approach designed for preemptive threat mitigation and continuous enhancement, Cisco leverages in-house technologies and research to fortify its system architecture against emerging threats. Incorporating robust industry practices and adhering to stringent security protocols, the UCS and Intersight platforms are built to meet the highest standards of security certifications, ensuring compliance with regulatory frameworks, and assuring customers of a resilient and safeguarded infrastructure. Moreover, the management features embedded within the solution provide administrators with comprehensive tools for monitoring, auditing, and controlling access, enabling proactive threat identification and rapid response to potential security breaches.

In addition to its development and certification framework, Cisco UCS utilizes advancements in confidential computing and secure storage to keep user applications and data protected. Implementing NIST-approved encryption techniques, secure boot processes, and hardware-based isolation mechanisms, UCS ensures data confidentiality, integrity, and availability throughout its lifecycle. Through secure storage solutions and federally certified secure interfaces, users leverage the UCS platform confidently, knowing that their data remains protected against unauthorized access. This white paper discusses the implementation of these features, demonstrating how UCS meets and exceeds the security and accountability requirements in today’s enterprise environments.

For a general overview of UCS-based security, see the white paper here: [Cisco Compute Security Overview White Paper - Cisco](#).

## The Cisco Secure Development Lifecycle – CSDL

Cisco products and components are developed, integrated, and tested using the Cisco Secure Development Lifecycle (CSDL). Secure product development and deployment has several components, ranging from following specified design and development practices, to testing their implementation, to providing customers with a set of recommendations for deployments that maximize the security of their system.

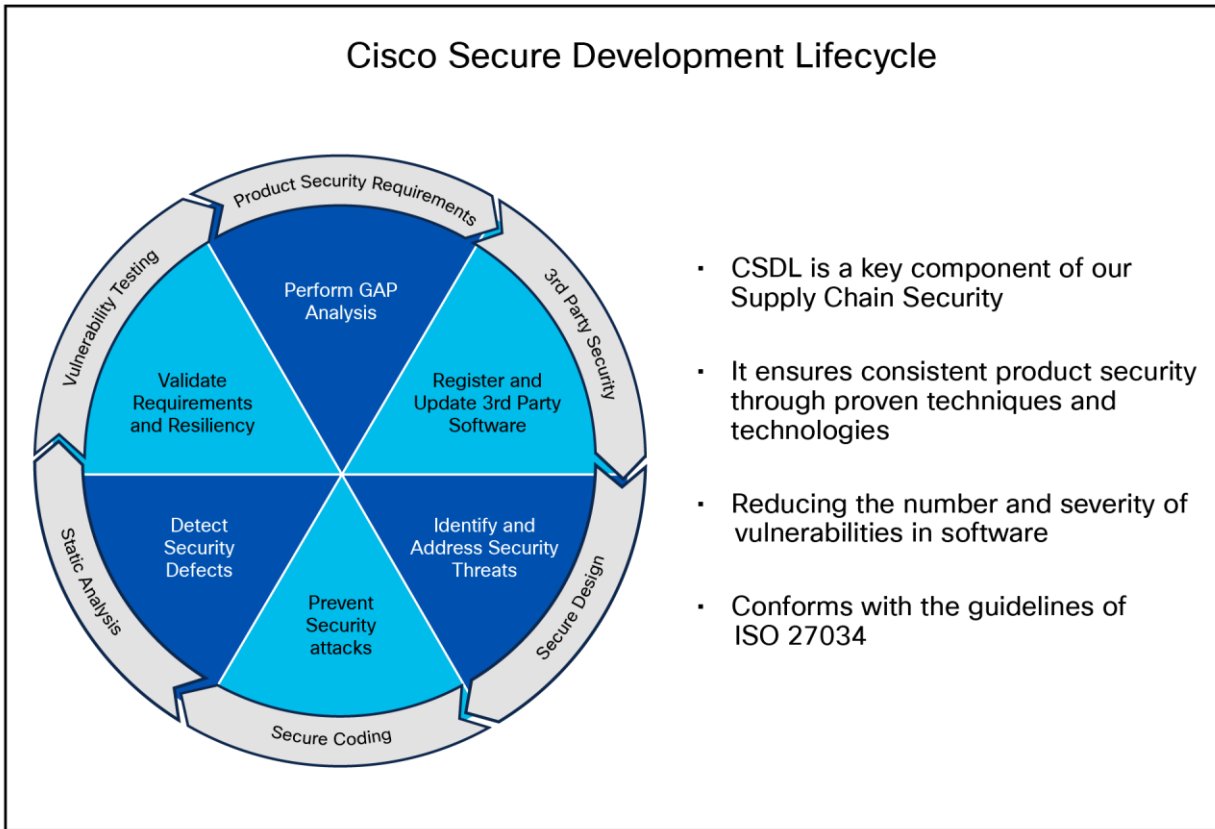

**Figure 1.**  
The Cisco Secure Product Development Lifecycle

---

## CSDL philosophy

A poor product design can open the way to vulnerabilities. The CSDL is designed to mitigate these potential issues. At Cisco, our secure-design approach requires two types of considerations:

- Design with security in mind
- Use threat modeling to validate the design's security

Designing with security in mind is an ongoing commitment to personal and professional improvement through:

- Training
- Applying Product Security Baseline (PSB) design principles
- Considering other industry-standard secure-design principles
- Being aware of common attack methods and designing safeguards against them
- Taking full advantage of designs and libraries that are known to be highly secure
- Protecting all potential entry points

Cisco also reduces design-based vulnerabilities by considering known threats and attacks:

- Follow the flow of data through the system
- Identify trust boundaries where data may be compromised
- Based on the data flow diagram, generate a list of threats and mitigations from a database of known threats, tailored by product type
- Prioritize and implement mitigations to the identified threats

The goal of this effort is to enforce a set of security processes and ensure a security mindset at every stage of development:

- Secure design
- Secure coding
- Secure analysis
- Vulnerability testing
- Secure deployments

## Development milestones

Each iteration of the product's development addresses needs for ongoing security fixes and general feature enhancements that include security components (new deployment models, changes in management, partner onboarding, etc.). At every stage of development, the product(s) undergo potential enhancements relative to findings and new features.

- The system is configured in the Quality-Assurance (QA) testing stage to accommodate the relevant settings identified above and run through a typical deployment test.
- The result is a validated set of best practices for security and is communicated through the CSDL process and exposed in the documentation.



## CSDL product adherence methodologies

Cisco CSDL adheres to Cisco Product Development Methodology (PDM), ISO/IEC 27034, and ISO 9000 compliance requirements. The ISO/IEC 27034 standard provides an internationally recognized standard for application security. Details for ISO/IEC 27034 can be found [here](#). The ISO 9000 family of quality management systems standards is designed to help organizations ensure that they meet the needs of customers and other stakeholders while meeting statutory and regulatory requirements related to a product or service. ISO 9000 details are [here](#).

The CSDL process is not a one-time approach to product development. It is recursive, with vulnerability testing, penetration testing, and threat modelling added to subsequent development of CSDL. This process follows ISO 9000 and ISO 27034 standards as part of an internationally recognized set of guidelines. The approaches involved often use a solution-wide methodology; for example, utilizing our continually updated CiscoSSL crypto module to guarantee that Cisco UCS (along with other elements in the Cisco offering) is always secure and meets FIPS certification requirements.

## Cisco Security and Trust Organization

Cisco Security and Trust Organization (S&TO) has the core responsibility to implement CSDL. In the effort to accomplish this, S&TO encompasses various groups with core responsibilities to deliver a secure product or respond to security concerns as they arise.



**Figure 2.**  
The groups within Cisco S&TO

---

Intersight's ongoing commitment to security and compliance through annual external audits ensures that customer information is handled responsibly. In addition, Cisco's Product Security Incident Response Team (PSIRT) manages the receipt, investigation, and public reporting of security vulnerabilities related to Cisco products and networks. The team works with Cisco customers, independent security researchers, consultants, industry organizations, and other vendors to identify possible security issues with Cisco products and networks.

## Supply-chain security

A critical aspect of secure product development and deployment is ensuring that the components that go into the system are legitimate and uncompromised. To this end, Cisco takes exceptional measures to ensure supply chain integrity.

### Counterfeit prevention

The Cisco Value Chain describes the development model used for all Cisco products, including Cisco HyperFlex®. Cisco is a leader in industry and international standards on counterfeit reduction and has been engaged in decades-long efforts to prevent and detect the distribution of counterfeit products. Cisco incorporates tools and processes to prevent counterfeiting—beginning with product development, through the manufacturing process, and in the marketplace.

In collaboration with Cisco's Brand Protection, legal, and other teams, an end-user portal has been developed to aid customers in these efforts and can be accessed at: [anticounterfeit.cisco.com](https://anticounterfeit.cisco.com).

Cisco's Brand Protection Team has conducted numerous investigations into counterfeiting operations and worked with local law enforcement to disrupt those operations. The portal includes examples of the Brand Protection Team's work over the years and the numerous resources that are available for Cisco customers and partners.

The Cisco Value Chain has the following characteristics:

- Comprehensive across all stages of a solution's lifecycle
- Multilayer approach, with focused protection against:
  - Source-code corruption
  - Hardware counterfeit
  - Misuse of intellectual property

This multilayered approach is shown in Figure 3.

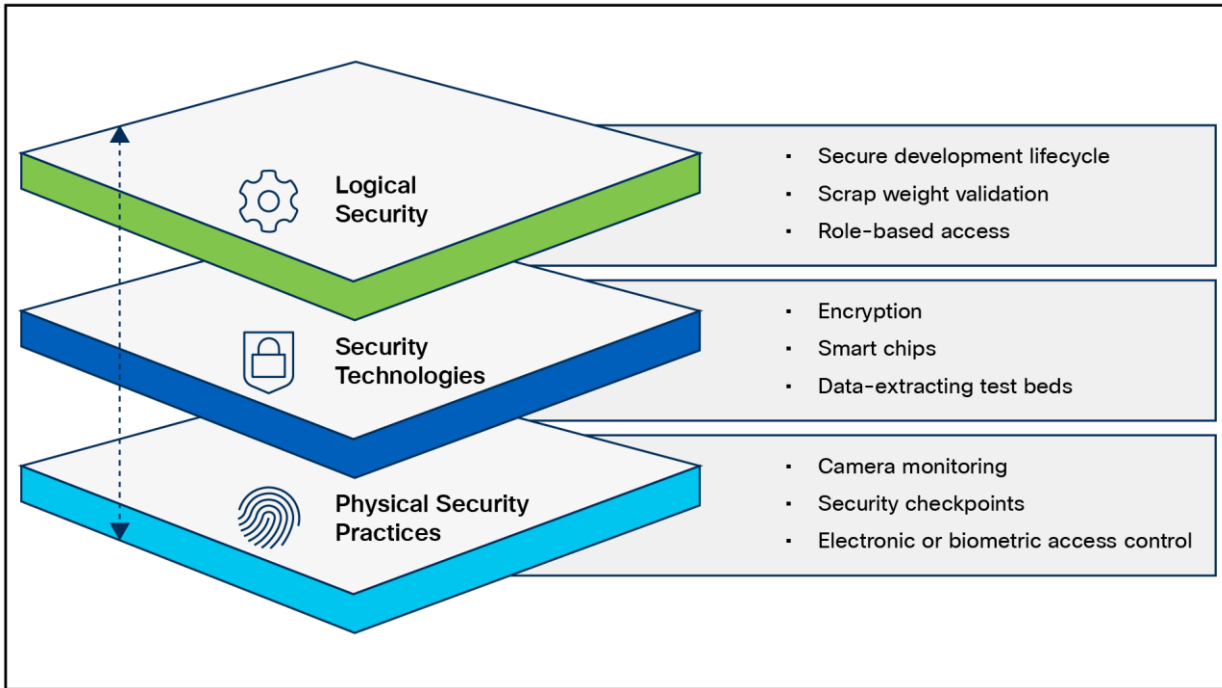

**Figure 3.**  
Layers of the Cisco Value Chain

## Consortiums for secure vendors

**Table 1.** Secure vendor consortium memberships

Name	Component(s)	Description	Status
<b>TAPA</b>	Supply chain	The Transported Asset Protection Association's (TAPA) Security Standards act as a worldwide benchmark for supply-chain security and resilience, providing guidance, processes, and tools that reduce loss exposure, protect assets, and the costs of cargo theft.	Member
<b>C-TPAT</b>	Supply chain	Customs Trade Partnership Against Terrorism (CTPAT) Trade Compliance Program is a voluntary program that provides the opportunity for importers who have made a commitment of resources to assume responsibility for monitoring their own compliance in exchange for benefits.	Member

---

## Advisories, vulnerabilities, and incident responses

### **CERT advisories**

Cisco's Computer Emergency Response Team (CERT) advisories are transmitted when new vulnerabilities are identified. Cisco's internal CERT team monitors and alerts product groups to potential issues that might affect their respective components. When these items are identified by CERT or are otherwise indicated by vendor partners (VMware, etc.), patches are either developed or acquired from the respective vendors. Cisco has heavily invested to protect customers by creating this team, which constantly monitors threats and builds a centralized solution to remediate these issues and vulnerabilities.

### **Additional vulnerability testing measures**

Cisco also utilizes an internal tool for threat modeling called Threat-builder. This tool is used to explicitly map out application components and services and to identify potential attack surfaces and develop line items for direct evaluation. This information, along with industry tools, is used for vulnerability and exploit testing by Cisco's ASIG (Advanced Security Initiatives Group). ASIG also uses fuzzing and manual testing as part of its suite of tools.

### **Running vulnerability scans against PVA/CVA**

PVA and CVA have an abstracted shell (such as IOS®, HXCLI, etc.). You cannot run a credentialed root scan against this shell. The backing, embedded operating system is currently CentOS, but that will soon change to Alma. You will not be able to enter the development debug shell.

### **Incident response**

The Cisco Product Security Incident Response Team (PSIRT) is responsible for responding to Cisco product security incidents. The Cisco PSIRT is a dedicated, global team that manages the receipt, investigation, and public reporting of information about security vulnerabilities and issues related to Cisco products and services. Cisco defines a security vulnerability as a weakness in the computational logic (for example, code) found in software and hardware components that, when exploited, results in a negative impact to confidentiality, integrity, or availability. Cisco reserves the right to deviate from this definition based on specific circumstances. The Cisco PSIRT adheres to ISO/IEC 29147:2018, which is a set of [guidelines for disclosure of potential vulnerabilities](#) established by the International Organization for Standardization.

The Cisco PSIRT is on call and works 24 hours a day with Cisco customers, independent security researchers, consultants, industry organizations, and other vendors to identify possible security vulnerabilities and issues with Cisco products and networks.

All vulnerabilities disclosed in Cisco Security Advisories are assigned a Common Vulnerability and Exposures (CVE) identifier and a Common Vulnerability Scoring System (CVSS score) to aid in identification. Additionally, all vulnerabilities are classified based on a Security Impact Rating (SIR).

Cisco uses version 3.1 of CVSS as part of its standard process of evaluating reported potential vulnerabilities in Cisco products. The CVSS model uses three distinct measurements or scores that include base, temporal, and environmental calculations. Cisco provides an evaluation of the base vulnerability score and, in some instances, a temporal vulnerability score. End users are encouraged to compute the environmental score based on their network parameters.

In addition, Cisco uses the Security Impact Rating (SIR) to categorize vulnerability severity in a simpler manner. The SIR is based on the CVSS base score, adjusted by PSIRT to account for variables specific to Cisco, and is included in every Cisco Security Advisory.

---

Cisco PSIRT assigns a Common Vulnerabilities and Exposures Identifier (CVE ID) to any vulnerability that is found in Cisco products and that qualifies to receive this identifier. Usually, all vulnerabilities with medium, high, or severe SIRs – that is, a CVSS score of 4.0 or greater – will qualify for a CVE ID.

## The Intersight solution

### **Solution components**

Cisco UCS has a unique architecture that integrates compute, data-network access, and storage-network access into a common set of components under a single pane of glass management interface. Cisco UCS fuses access-layer networking and servers. This high-performance, next-generation server system provides a data center with a high degree of workload agility and scalability. The hardware and software components support Cisco's unified fabric, which runs multiple types of data-center traffic over a single converged network adapter.

A Cisco UCS compute system is available in many blade or rack-mount configurations. With Intersight, systems that come with Fabric Interconnects (FIs) are configured at build time to run with Intersight's cloud-management services (Intersight Managed Mode, IMM). Systems without FIs will run in standalone mode and can be claimed by Intersight using a two-factor authentication mechanism that requires access to the system.

### **Cisco Intersight Virtual Appliance**

Cisco Intersight Virtual Appliance delivers the management features of Intersight in an easy-to-deploy VMware OVA, Microsoft Hyper-V Server VM, and KVM hypervisor. Intersight Virtual Appliance provides the benefits of Cisco Intersight that offers an intelligent level of management to enable customers to analyze, simplify, and automate their environments in more advanced ways than the previous generations of tools, while allowing more flexibility with additional data locality, security, and compliance requirements.

You can deploy Intersight Virtual Appliance in one of the following modes:

- Intersight Connected Virtual Appliance
- Intersight Private Virtual Appliance

Intersight Connected Virtual Appliance delivers the management features of Intersight while allowing you to control what system details leave your premises. Intersight Connected Virtual Appliance deployments require a connection back to Cisco and Intersight services for automatic updates and access to services for full functionality.

Intersight Private Virtual Appliance delivers the management features of Intersight and allows you to ensure that no system details leave your premises. Intersight Private Virtual Appliance deployments are intended for an environment where you operate data centers in a disconnected (air-gapped) mode.

For an overview of Intersight Assist, see [About Cisco Intersight Assist](#).

You can deploy Intersight Virtual Appliance as a single-node virtual machine in your existing environment.

You can also deploy Intersight Virtual Appliance on VMware vSphere as a multi-node cluster, which allows for high availability. Once you have completed the initial setup of the single-node appliance, you can add additional nodes. After you successfully add two additional nodes, you can create a multi-node cluster in Intersight Virtual Appliance.

---

## Multi-Node Intersight Virtual Appliance

The Intersight Virtual Appliance is capable of multi-node deployment for fault tolerance. This provides customers with a highly available and resilient on-premises deployment option to manage their data-center infrastructure.

- **Appliance resiliency** – Protection against disruptions, thus providing zero downtime for Intersight services
- **Flexible configuration** – Virtual nodes available within or across data centers if meeting latency and bandwidth requirements
- **Migration path from a single-node deployment** – Expandable from existing deployments to leverage these new capabilities

For more information:

- [Configuring a Multi-Node Cluster for Intersight Virtual Appliance](#)
- [Migration Path for Expanding Existing Single-Node Deployment to Multi-Node Cluster Configuration](#)

## Certifications

Federal compliance and audit-based certifications are a critical component of a standardized and predictable security posture. They are critical in most federal deployments, especially those dealing with financial and defense arenas. The Cisco Global Certification Team (GCT) works to complete various certifications.

### SOC 2 Type 2

**System and Organization Controls (SOC)** (also sometimes referred to as service organizations controls), as defined by the [American Institute of Certified Public Accountants \(AICPA\)](#) is the name of a suite of reports produced during an audit. SOC is intended for use by service organizations (organizations that provide information systems as a service to other organizations) to issue validated reports on [internal controls](#) over those information systems to the users of those services.

SOC compliance and audits are intended for organizations that provide services to other organizations. For example, a company that offers cloud-hosting services may need SOC compliance. For Cisco and its customers, this is relevant for the Cisco Intersight SaaS cloud service.

There are two levels of SOC reports that are also specified by Statement on Standards for Attestation Engagements (SSAE) 18:

- Type 1, which describes a service organization's systems and whether the design of specified controls meet the relevant trust principles
- Type 2, which also addresses the operational effectiveness of the specified controls over a period of time (usually 9 to 12 months)

There are three types of SOC reports:

- SOC 1 – Internal Control over Financial Reporting (ICFR)
- SOC 2 – Trust Services Criteria
- SOC 3 – Trust Services Criteria for General Use Report

SOC 2 Type 2 certified: meets controls for confidentiality, security, and availability, among others.

---

SOC 2 reports focus on controls addressed by five semi-overlapping categories called Trust Service Criteria:

1. Security
  - a. Firewalls
  - b. Intrusion detection
  - c. Multifactor authentication
2. Availability
  - a. Performance monitoring
  - b. Disaster recovery
  - c. Incident handling
3. Confidentiality
  - a. Encryption
  - b. Access controls
  - c. Firewalls
4. Processing integrity
  - a. Quality assurance
  - b. Process monitoring
  - c. Adherence to principle
5. Privacy
  - a. Access control
  - b. Multifactor authentication
  - c. Encryption

The SOC 2 Audit provides the organization's detailed internal controls report made in compliance with the five trust service criteria. It shows how well the organization safeguards customer data and assures them that the organization provides services in a secure and reliable way.

---

## SOC 3

SOC 3 for Service Organizations: Trust Services Criteria for General Use Report is a short, publicly facing summary of the SOC 2 Type 2 attestation report for users who need assurances about a service organization's controls but do not need a full SOC 2 report or are not eligible under SOC 2 to receive one. Because SOC 3 reports are general-use reports, they can be freely distributed.

A SOC 3 report contains a written assertion by service-organization management regarding control effectiveness to achieve commitments based on the applicable trust services criteria, and the service auditor's opinion on whether management's assertion is stated fairly.

Cisco Intersight SOC 3 [https://trustportal.cisco.com/c/r/ctp/trust-portal.html?search\\_keyword=intersight#/1632370623703433](https://trustportal.cisco.com/c/r/ctp/trust-portal.html?search_keyword=intersight#/1632370623703433).

## FIPS

The Federal Information Processing Standard (FIPS) Publication 140-2 is a U.S. government computer-security standard used to approve cryptographic modules.

Cisco UCS is compliant with FIPS140-2 level 1 through direct implementation of the FIPS-compliant CiscoSSL crypto module. The module, once implemented, is vetted by a third party that is federally certified to ascertain compliance status.

- Utilizes CiscoSSL module
  - Already FIPS compliant
  - SSH-approved cipher list
  - SSL/TLS implementation
  - Eliminates weak or compromised components
- Regularly updated
- Lab validates that the module is incorporated correctly
  - Build logs
  - Source-access-identifying calls to the module
  - All admin access points to the cluster are covered here.
- SSH for CLI
- HTTPS for UI



A comprehensive list of Cisco FIPS-compliant products is given below, along with the corresponding reference with NIST:

- Cisco FIPS-certified products: <https://www.cisco.com/c/en/us/solutions/industries/government/global-government-certifications/fips-140.html>
- Cryptographic Module Validation Program (CMVP) vendor list: [Cryptographic Module Validation Program | CSRC \(nist.gov\)](#)

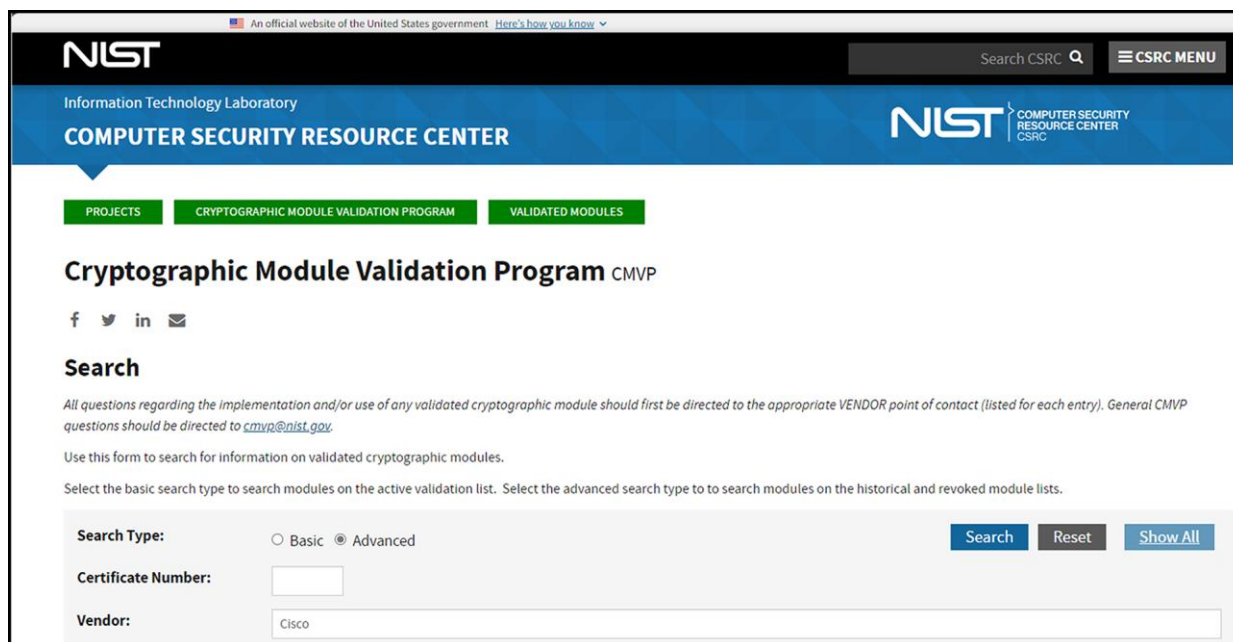

**Figure 4.**  
FIPS vendor listings

**Note:** FIPS 140-2 level 2 on PVA/CVA is only applicable to single-node appliance.

## CNSA (Commercial National Security Algorithm)

This is a schema that is detailed in RFC 9151: [RFC 9151: Commercial National Security Algorithm \(CNSA\) Suite Profile for TLS and DTLS 1.2 and 1.3 \(rfc-editor.org\)](#)

The Commercial National Security Algorithm (CNSA) describes which algorithms should be in use and what their profiles should look like. It is intended to give guidance for secure and interoperable communications, including guidelines for certificates, for national security reasons.

---

Cisco supports both Elliptic Cryptographic Certificates (ECC) and RSA certificates, so these requirements are met:

- Elliptic Curve Digital Signature Algorithm (ECDSA) and Elliptic Curve Diffie-Hellman (ECDH) key pairs are on the curve P-384. FIPS 186-4, Appendix B.4, provides useful guidance for elliptic curve key pair generation that should be followed by systems that conform to the RFC.
- RSA key pairs (public or private) are identified by the modulus size expressed in bits; RSA-3072 and RSA-4096 are computed using moduli of 3072 bits and 4096 bits, respectively. Cisco's FIPS certification through CiscoSSL implements federally approved crypto modules to satisfy the complexity requirements as well.

CNSA compliance is just a matter of making sure to implement a cryptographic ecosystem according to the CNSA requirements since Cisco UCS supports all the documented methods.

### Other certifications and procedural guidelines

ISO/IEC 27001 is not a certification for specific pieces of hardware as much as it is a dozen or so “best practices” in the form of checklists and guidelines for how organizations manage their security controls internally. It observes such things as building access, password management, badging into a copier to make copies, etc. Training on a frequent basis is a part of the standard.

Cisco is ISO/IEC 27001-certified. This is a link to our ISO/IEC 27001 certificate: [Cisco Secure Cloud Analytics \(StealthWatch®\) ISO/IEC 27001:2013, 27017:2015, 27018:2019](#).

ISO/IEC 27001:2013: the Cisco Intersight platform has completed its ISO/IEC 27001:2013 First Surveillance Audit from the external certification body/auditor Coalfire, and the certificate issued has been uploaded to [Trust Portal site](#). The First Surveillance Audit included a review of the establishment and overall operating effectiveness of control areas that form Cisco Intersight's information security management system.

## Intersight regions

Cisco Intersight supports two regions: the existing North America region (us-east-1) and the Europe, Middle East, and Africa (EMEA) region (eu-central-1).

Benefits include:

- **Compliance:** multi-region support helps meet local regulatory requirements such as control, confidentiality of personal and sensitive data, availability, and service resilience.
- **Improved performance and latency:** deployments can use an Intersight instance closer to the geographic location of users and devices.
- **Seamless connection and configuration:** no new workflows are required. All regions include the same familiar Intersight configuration and management experience. Connection and configuration changes are also the same in all regions.
- **Data sovereignty with the same user experience:** the Intersight EMEA user experience is the same in all regions. Users are automatically redirected to their account's region to maintain data sovereignty requirements.

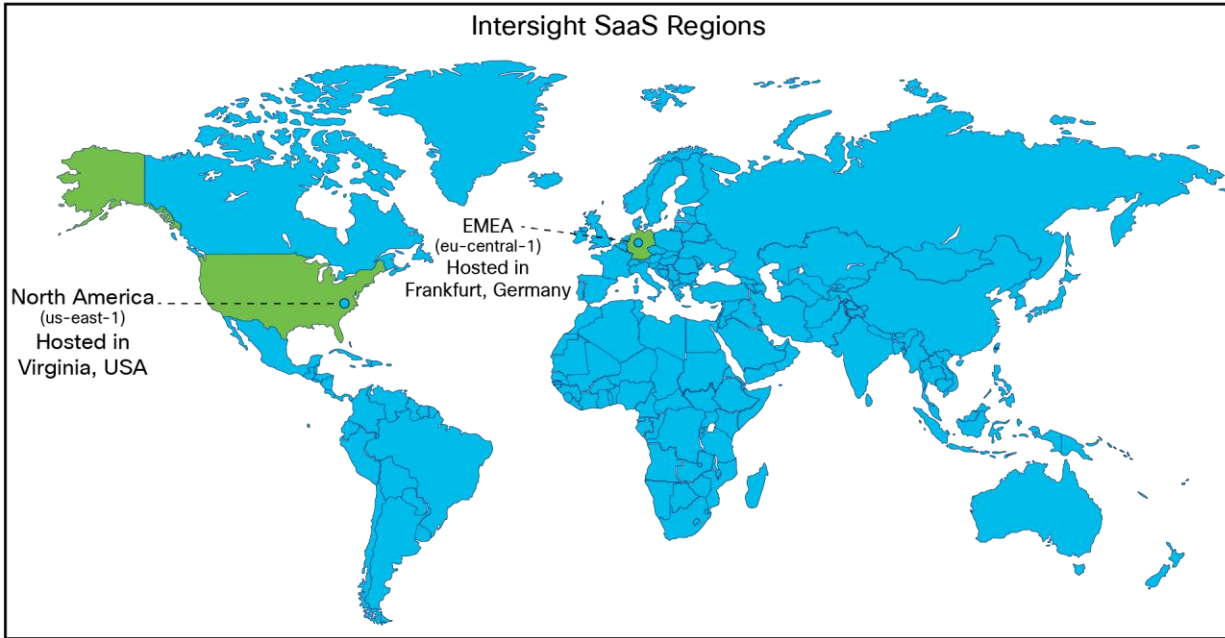

**Figure 5.**  
Intersight global regions

The various regions offer global feature parity. All regional customers enjoy all new features at the same time. Creating new Intersight accounts is also as simple as using a drop-down menu, as shown in Figure 6.

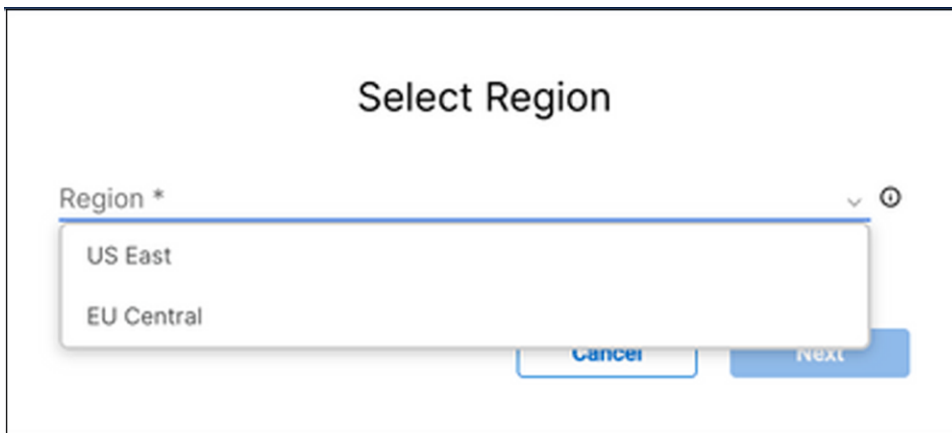

**Figure 6.**  
Region selection on account creation

The selected region determines which Intersight SaaS regional instance will be used to store customers' data to help comply with local laws and data residency regulations while achieving low latency. Users can seamlessly switch between accounts in different regions.

The Intersight claiming process is unified for all regions. When a target is claimed, data is stored in the region of the account that claimed the target, and all interactions with Intersight are performed in the local region. In the example multi-region illustration below, targets in Spain, United Kingdom, and India are managed by the EMEA instance while targets in Australia, Africa, and South America are managed by the North American instance.

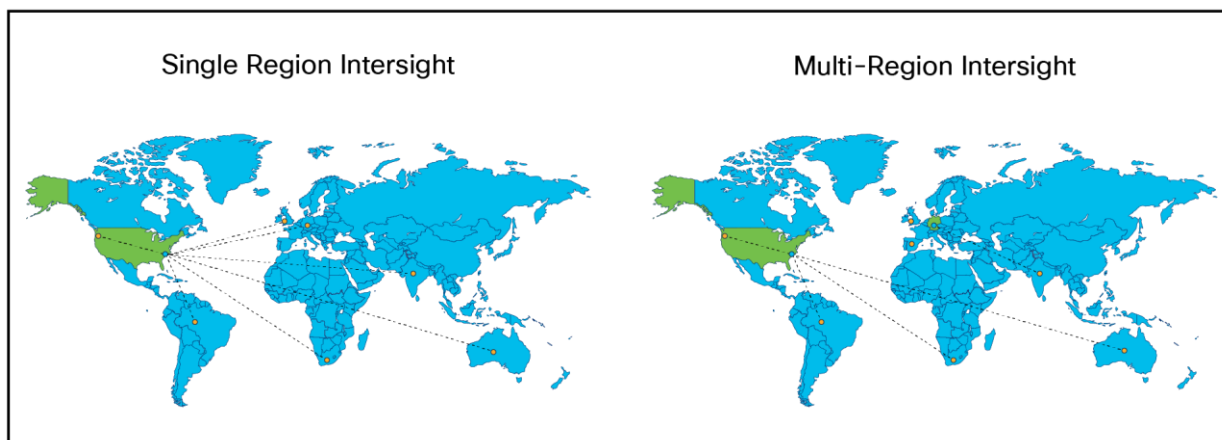

**Figure 7.**  
Multi-region Intersight account locations

If you are using Intersight SaaS or the CVA and either created your account before the EMEA instance was available or selected the wrong region during account creation, there is no back-end migration of data to the EMEA instance. Normally a CVA is claimed to an Intersight account just as a regular endpoint is claimed in a SaaS deployment. This Intersight account can be created in the U.S. or Europe. If a CVA or endpoint is claimed to an Intersight account in the U.S., then it stays there. If the data is required to be kept in the EMEA instance, then an Intersight account should be created in the EMEA hub, and the CVA and/or endpoints need to be unclaimed from the old account in the U.S. and reclaimed to the new account in EMEA.

### **Intersight point-of-presence replication and attack hardening**

Enterprise security services that are internet exposed must be able to be deployed such that they are resilient to volumetric Distributed Denial of Service (DDOS) and common web-based attacks. These are handled by Amazon Web Services (AWS) security services that host Cisco Intersight SaaS. Similarly, AWS manages the multi-PoP (point of presence) and active/failover configurations as defined in the AWS Recovery Point Objective (RPO) and Recovery Time Objective (RTO) contracts.

---

## Intersight privacy and data retention

Intersight collects a subset of the information in the Intersight privacy data sheet. For details, see [Cisco Cloud Services delivered by the Intersight Platform, including Nexus Cloud Privacy Data Sheet](#).

### Usage notes for the EMEA (eu-central-1) region:

- Inventory data for unclaimed devices is temporarily stored in the U.S. region until the device is claimed by an EMEA account. After the device is claimed, any previously collected data is purged from the generic U.S. Intersight account to which all unclaimed devices belong. The data is retained in the Intersight backup as specified in the [Cisco Cloud Services delivered by the Intersight Platform Data Sheet](#).
- Cisco Technical Assistance Center (Cisco TAC) support, as a global service, may need to move customer tech-support data to a different region for troubleshooting and analysis. Deployments can use an Intersight instance closer to the geographic location of users and devices.
- The Intersight default setting for tech support is to allow collection of incident information. To turn this off, see [Disabling Tech Support Bundle Collection](#). Only an account administrator can modify the setting.
- The [Proactive RMA system](#) automatically generates a Service Request (SR) and a Return Material Authorization (RMA) when products experience certain failures. To turn off this service, see [Opting out of Proactive RMAs](#).

### Data collected and encrypted at rest

- The Intersight platform has complete visibility into and control over managed systems, the same as local API access. Data collected from device connectors on managed systems may include the following:
  - Inventory and configuration data for fabric interconnects and all servers and nodes, including storage controllers, network adapters, I/O modules, and CPUs
  - Server operational data (such as faults) that can be used by the Intersight platform to provide automated recommendations
  - Technical support files that can be created when requested by Cisco TAC

Note that device connectors do not collect sensitive data that may be stored in the connected systems, such as passwords. If you use the Cisco Intersight Connected Virtual Appliance, you have control over whether the above data is passed on to the cloud-based portal. If you opt out of additional data collection, the above information is kept locally. The Intersight help pages have more information on data collected by the on-premises Cisco Intersight Virtual Appliance.

For all data collected, the following additional security practices are implemented:

- Customer data is kept separate from other customer data through virtual data segregation. Data requests by Cisco Intersight services return data specific to the customer account only, and per-customer encryption keys are used for access.
- Long-term persistent data is encrypted at rest. Block storage or similar volume encryption is enabled for all data and tenant files.
- Third-party access to data is not permitted.

There is no user data that is stored in any Intersight instance; only meta-data is collected. If you have a support case open with Cisco TAC, only the TAC engineer that is assigned to the Support Request (SR) created by the end user can generate tech-support logs.

---

## What can Cisco TAC access?

Cisco TAC does not have access to login data. TAC engineers can generate tech-support bundles, but policies, profiles, pools, etc., are not exposed in the case viewer for TAC. The TAC team uses the "Technical Assistance User" role, which is defined as a **"Limited number of approved Cisco employees with read-only access to the Intersight web portal UI across all Intersight accounts, and the ability to trigger serviceability functions such as tech support bundle collection and downloading tech support data."**

Expected by Q3CY24, instead of enabling the general Technical Assistance User role for TAC, a new "TAC Support-Services role" will provide read-only access to specific TAC engineers based on the mapping of an SR and authorization to the TAC engineer.

Engineers will be able to operate with the "support-services" role in the customer's account, giving the customer auditability of which TAC engineers were able to see their data.

Even after this is implemented, TAC will never have access to passwords to log into devices.

## Data retention

Tech-support bundles are retained for two years. The meta data from CVA is retained while the Intersight account is active.

## Data backup for PVA and CVA

Backing up of a Cisco Intersight Virtual Appliance regularly is essential. Without regular backups, there is no automatic way to reconstruct the configuration settings and recreate the profiles and policies. You can perform a regular backup once a day using a scheduled backup or create backup to guard against a data-loss or -corruption event. Cisco Intersight Virtual Appliance enables you to take a full-state backup of the data in the appliance and store it in a remote server. If there is a total site failure or another disaster recovery scenario, the restore capability enables you to do a full-state-system restore from the backed-up system data.

The following options are available to back up data:

- **Create backup** – creates on demand a full-state backup of the data in Cisco Intersight Virtual Appliance and saves the backed-up data on a remote server
- **Schedule backup** – performs a full-state periodic backup of the data in the appliance based on a schedule and saves the backed-up data on a remote server

---

## System-level security

### System boot

A secure system boot relies on a set of trusted Cisco technologies. Here are the fundamental concepts of Cisco trustworthy technologies:

### Component chain of trust

A chain of trust exists when the integrity of each element of code in a system is validated before that piece of code is allowed to run. A chain of trust starts with a root-of-trust element. The root of trust validates the next element in the chain (usually firmware) before it is allowed to start, and so on. Using signing and trusted elements, a chain of trust can be created that boots the system securely and validates the integrity of Cisco software.

### Hardware root of trust – Trust Anchor Module (TAM) and Trusted Platform Module 2.0 (TPM)

A trusted element in a system's software is a piece of code that is known to be authentic. A trusted element must either be immutable (stored in such a way as to prevent modification) or authenticated through validation mechanisms. Cisco anchors the root of trust, which initiates the boot process, in tamper-resistant hardware. The hardware-anchored root of trust protects the first code running on a system from compromise and becomes the root of trust for the system.

The Trust Anchor module (TAM) is a proprietary, tamper-resistant chip found in many Cisco products and features nonvolatile secure storage, a Secure Unique Device Identifier (SUDI), and crypto services, including Random Number Generation (RNG), secure storage, key management, and crypto services for the running OS and applications.

The hardware root of trust is a Cisco ACT2 Trust Anchor Module (TAM). This module has the following characteristics:

- Immutable Identity with IEEE 802.1AR (Secure UDI- X.509 cert)
- Anti-theft and anti-counterfeiting
- Built-In cryptographic functions
- Secure storage for certificates and objects
- Certifiable NIST SP800-92 random number generation

Once a system is securely booted, it is often important to get external verification that this is indeed the case. This is done through attestation. "Attestation" is evidence of a result, that is, "The host was booted with secure boot enabled and signed code." This is accomplished through the Trusted Platform Module (TPM).

## Immutable identity

The Secure Unique Device Identifier, or SUDI, is an X.509v3 certificate that maintains the product identifier and serial number. The identity is implemented at manufacturing and is chained to a publicly identifiable root-certificate authority. The SUDI can be used as an unchangeable identity for configuration, security, auditing, and management.

The SUDI credential in the Trust Anchor module can be either RSA- or Elliptic Curve Digital Signature Algorithm (ECDSA)-based. The SUDI certificate, the associated key pair, and its entire certificate chain are stored in the tamper-resistant Trust Anchor module chip. Furthermore, the key pair is cryptographically bound to a specific Trust Anchor chip, and the private key is never exported. This feature makes cloning or spoofing the identity information virtually impossible.

The SUDI can be used for asymmetric key operations such as encryption, decryption, signing, and verifying that allow passage of the data to be operated upon. This capability makes remote authentication of a device possible. It enables accurate, consistent, and electronic identification of Cisco products for asset management, provisioning, version visibility, service entitlement, quality feedback, and inventory management.

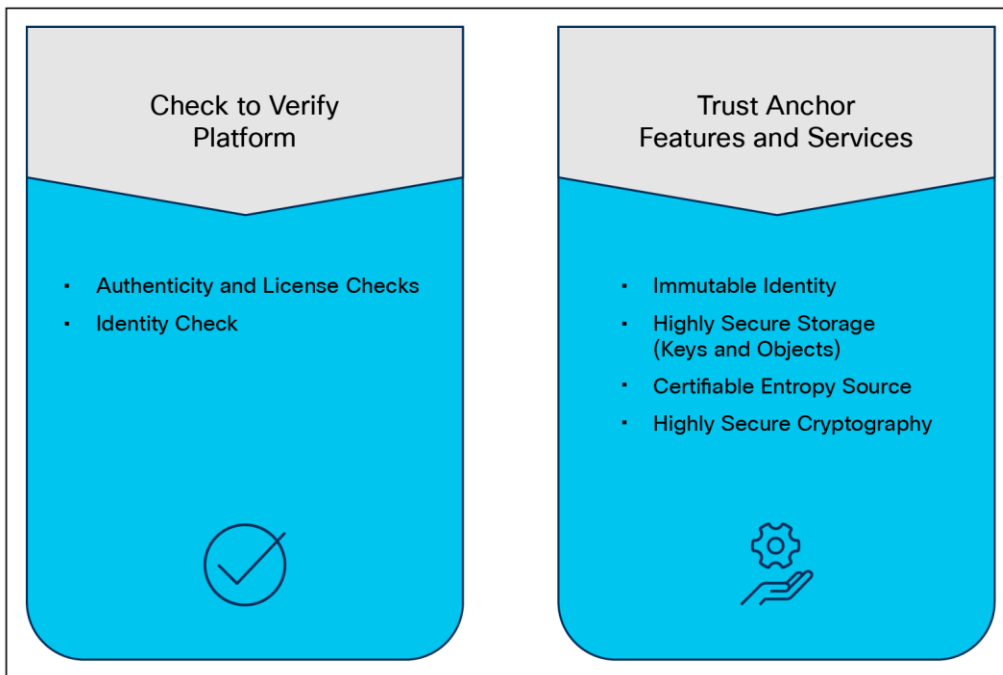

**Figure 8.**  
TAM functions



---

Currently the secure boot process, when enabled, is in effect during boot, including of both the system firmware and the installed operating system. The end-to-end security model that this enables, when combined with the secure UI and CLI, encompasses the hardware Trust Anchor module (TAM) to secure the system boot and to secure the OS boot with externally verifiable attestation using the Trusted Platform Module (TPM).

This implementation covers the following:

- Secure boot, secured by public keys stored in the write-protected hardware root of trust.
- Ensuring that only a trusted OS image, including drivers, is booted by verifying signatures.
- Attestation of secure boot through TPM 2.0.

The detailed process flow for secure boot of the system and OS with attestation capability is shown below. Note that the certificate-based hardware root of trust validates the UCS firmware, which ensures a clean BIOS set for key validation of the hypervisor bootloader, and so on. This guarantees that the hardware and hypervisor in the HyperFlex system have not been tampered with. External validation of this can be made through attestation using the TPM 2.0 module in UCS.

### **Image signing**

Image signing is a two-step process for creating a unique digital signature for a given block of code. First, a hashing algorithm, similar to a checksum, is used to compute a hash value of the block of code. The hash is then encrypted with a Cisco private key, resulting in a digital signature that is attached to and delivered with the image. Signed images may be checked at runtime to verify that the software has not been modified.

### **Secure boot**

Cisco Secure Boot helps to ensure that the code that executes on Cisco hardware platforms is authentic and unmodified. Cisco hardware-anchored secure boot protects the microloader (the first piece of code that boots) in tamper-resistant hardware, establishing a root of trust that helps prevent Cisco network devices from executing tainted network software. Subsequent boot of the installed operating system is verified and attested with the Trusted Platform Module (TPM).

Cisco Secure Boot helps ensure that the code that executes on Cisco hardware platforms is genuine and untampered. A typical UEFI-based boot process starts at the UEFI firmware and works up to the boot loader and the operating system. A tampered UEFI firmware can result in the entire boot process being compromised.

Using a hardware-anchored root of trust, digitally signed software images, and a unique device identity, Cisco hardware-anchored secure boot establishes a chain of trust that boots the system securely and validates the integrity of the software. The root of trust (a.k.a. the microloader), which is protected by tamper-resistant hardware, first performs a self-check, and then verifies the UEFI firmware, and thus kicks off the chain of trust leading to integrity verification of the entire operating system.

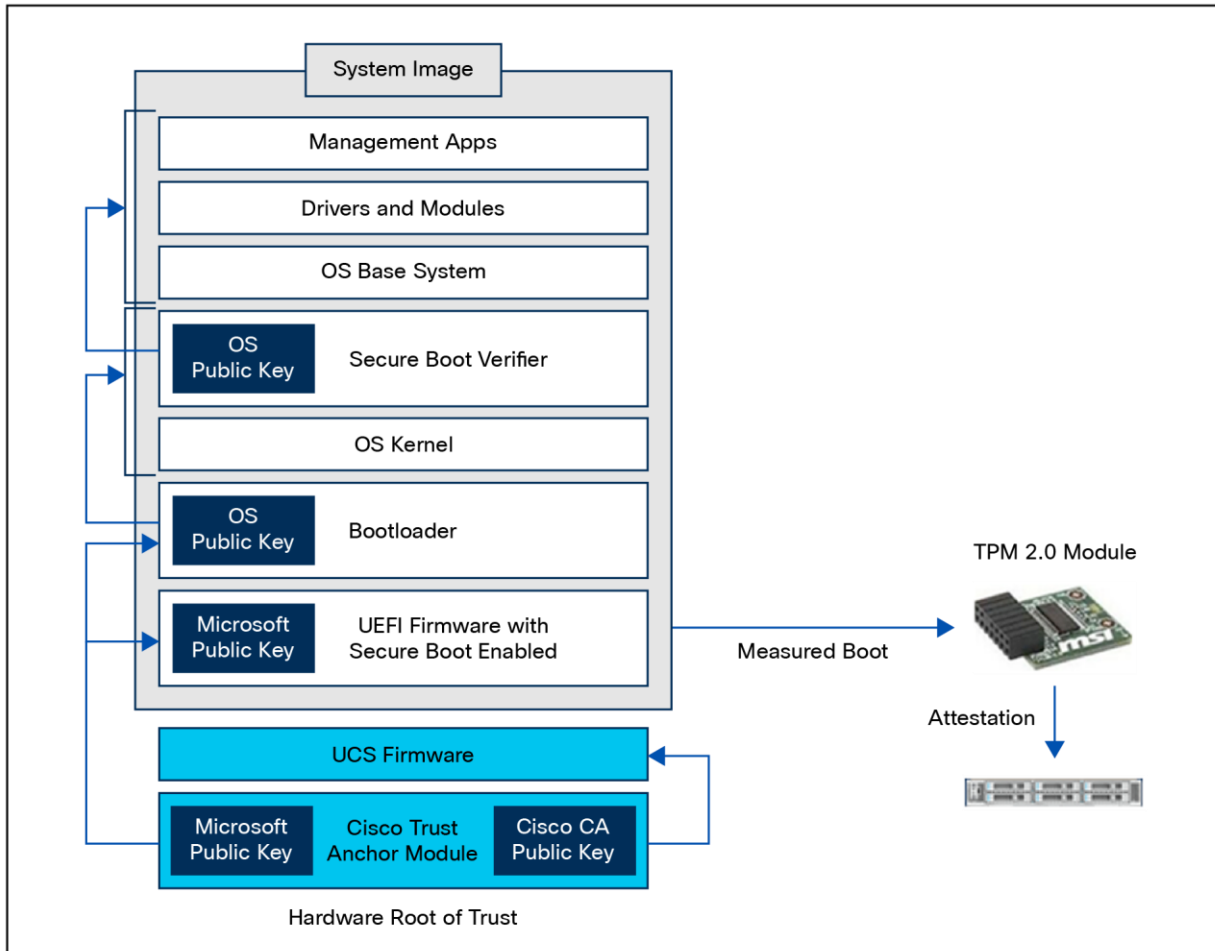

**Figure 9.**  
Secure Boot process

## Runtime defenses

Runtime Defenses (RTDs) target injection attacks of malicious code into running software. Cisco runtime defenses include Address Space Layout Randomization (ASLR), Built-in Object Size Checking (BOSC), and X-Space. Runtime defenses are complementary.

- They make it harder or impossible for attackers to exploit vulnerabilities in running software.
- Since runtime defenses are complementary, you can implement them individually or deploy several runtime defenses together.

---

## CPU hardware protections

Cisco UCS supports both Intel® and AMD processors. The latest generations of these CPUs and their accompanying chipsets have extensions and programmatic capabilities around memory encryption and secure code execution and isolation.

### Intel Boot Guard

Intel Boot Guard (4<sup>th</sup> gen CPU and greater) is a security technology designed to enhance the integrity of the boot process and protect against unauthorized firmware and bootloader modifications on systems using Intel processors. It is part of Intel's broader security initiatives to safeguard the boot process from potential threats and ensure the system starts up securely.

### AMD Platform Secure Boot (PSB)

AMD Platform Secure Boot (PSB) is a security feature designed to enhance the security of AMD processors and platforms by focusing on the boot process. PSB is part of AMD's security initiatives to protect against unauthorized code execution during the system boot-up process.

## Connecting to Intersight

There are three methods of running Intersight Managed Mode (IMM). These depend on the type of deployment the end user needs. For example, if there is a requirement for an air-gapped environment, but IMM is needed, an on-premises version of Intersight can be used. Here are the types of Intersight deployments:

- Cloud-based Cisco UCS management (Intersight SaaS)
  - This cloud-native approach provides a centralized, web-based interface accessible from anywhere. It simplifies IT management by eliminating the need for on-premises hardware and software, making it an ideal choice for organizations seeking agility, scalability, and easy access to the latest features.
- Connected virtual appliance (Intersight CVA)
  - For businesses that prefer an on-premises solution while still benefiting from cloud connectivity, the connected virtual appliance is the answer. It offers the flexibility to run the Intersight virtual appliance within the data center while maintaining seamless connections to the Intersight cloud for updates and technical support.
- Private virtual appliance (Intersight PVA)
  - If security and isolation are important factors, the private virtual appliance delivers an on-premises, air-gapped option. It operates in complete isolation from the Intersight cloud and the internet, ensuring that the infrastructure remains secure while still taking advantage of Intersight's management capabilities.

---

## Each of these deployments offers the following benefits:

- Unified management
  - Intersight consolidates the management of compute, network, storage, and hyperconverged infrastructure, simplifying the management of complex IT environments.
- Automation and orchestration
  - Intersight automates routine processes, which, in turn, reduces errors and accelerates deployments.
- Optimized operations
  - With proactive monitoring and intelligent analytics, Intersight helps identify and resolve issues before they impact an organization's business, ensuring maximum uptime.
- Security and compliance (including hardware compatibility list [HCL] features)
  - Stay ahead of security threats with real-time security alerts and compliance checks, keeping infrastructure protected and compliant with industry standards. Cisco Intersight also offers comprehensive Hardware Compatibility List (HCL) features, ensuring that an organization's hardware is not only compatible but also fully supported for seamless operations. The HCL features provide detailed insights into hardware compatibility, allowing informed decision making and optimal infrastructure for peak performance.
- Intersight Monitoring Services (IMS)
  - IMS provides historical and real-time visibility of resource consumption and inventory health, policies for notifications based on thresholds and anomaly detection, and actions and recommendations for automated infrastructure changes in response to events. IMS helps reduce operational costs, prevent SLA violations, and increase system reliability and availability.

## Data encryption and connection security

Secure and encrypted communication channels include only up-to-date and approved protocols and are used when migrating servers, services, applications, or data to cloud environments. Intersight is [ISO 27001](#) and [SOC 2 Type 2](#) certified, the highest level of certifications for cloud-based services. SOC 2 focuses controls as they relate to security, availability, processing integrity, confidentiality, and privacy of a system. To maintain SOC 2 Type 2 certification, companies must undergo periodic audits that prove their systems and control activities are effective over time.

Certified FIPS compliance for all communications:

- Intersight Connected Virtual Appliance
- Intersight Private Virtual Appliance
- Intersight Assist

## Timeout

The Transport Layer Security (TLS) session reuse timeout default is five minutes, but not the session close. The device connector establishes a persistent web socket, so the connection to Intersight is permanent.

Your Intersight web UI session is not permanent. If your session is idle for more than 30 minutes, your session will be removed.

---

## Target connections

For a successful target connection to Intersight, ensure that the following connectivity requirements are met:

- Establish a network connection to the Intersight platform from the Intersight device connector.
- Ensure that Intersight Management is enabled in Device Connector (it is enabled by default). You can find Intersight Management in Admin > Device Connector > Intersight Management in Cisco UCS Manager/Cisco UCS Director/Cisco IMC, and Settings > Device Connector in the Cisco HyperFlex UI.
- Check if a firewall is introduced between the managed target and Intersight, or if the rules for an existing firewall have changed, thus affecting connectivity. If the rules are changed, ensure that the changed rules permit traffic through the firewall.
- Ensure that all applicable physical and virtual IPs are allowed through the firewall.
- If you use an HTTP proxy to route traffic out of your premises, and if you have made changes to the HTTP proxy server's configuration, ensure that you change the device connector's configuration accordingly. This is required because Intersight does not automatically detect HTTP proxy servers.
- A valid CA-signed certificate is presented by the Intersight portal.
- Configure DNS and resolve the DNS name. The device connector must be able to send DNS requests to a DNS server and resolve DNS records. The device connector must be able to resolve URLs required by device connectors to an IP address.

Caution: Hosting the DNS used for Intersight DNS resolution in the same environment as what is being managed is not recommended.

- Configure NTP and validate that the device time is properly synchronized with a time server.

**Note:** When the device time is not properly synchronized, the device connector may be unable to establish a secure connection to Intersight, and the TLS certificate may be considered invalid.

You must configure DNS and NTP on the management interface (Cisco UCS Manager/Cisco IMC/Cisco HyperFlex) and not on the device connector UI.

- You must configure security devices that are in the network path by enabling network connectivity to URLs required by device connectors. For example, you must create firewall or web proxy rules.
- The device connector establishes an HTTPS connection to URLs required by device connectors and then upgrades the HTTPS connection to a web socket. Ensure that your security rules allow the device connector to establish a web socket.
- The following are the static IP addresses corresponding to each region:

### North America (us-east-1) region:

- svc-static1.intersight.com (**Preferred**).
- svc-static1.ucs-connect.com (**Will be deprecated in the future**).

Both these URLs resolve to the following IP addresses:

- 3.208.204.228
- 54.165.240.89
- 3.92.151.78

### EMEA (eu-central-1) region:

- svc-static1.eu-central-1.intersight.com

This URL resolves to the following IP addresses:

- 18.156.75.106
  - 52.58.223.59
  - 18.197.245.69
- You can access the Intersight portal and invoke the APIs using IPv6 addresses. The targets managed by Intersight can connect to Intersight through IPv6 addresses.

## Port requirements

The ports required to be open in a firewall for Intersight communication are listed in Table 2.

**Table 2.** Port requirements for Intersight communication

Port	Protocol	Communication Description
443	TCP/UDP	<ul style="list-style-type: none"><li>• Intersight and your web browser.</li><li>• Intersight and the endpoint targets, such as, all device connectors</li></ul> All device connectors must resolve svc.intersight.com and allow outbound-initiated HTTPS connections on port 443.
80	TCP	<ul style="list-style-type: none"><li>• Intersight and the endpoint target for upgrade of the device connector. Port 80 is required when the device connector version is lower than the minimum supported version.</li><li>• Port 80 is not used if the device connector is at the minimum supported version.</li></ul> The Intersight device connector uses <a href="#">Amazon Trust Services</a> to validate certificates. If you wish to leverage certificate validation, you must open port 80 and allow communication to <a href="#">amazontrust.com</a> in your firewall settings. Allowing for certificate validation is optional but recommended.

## Cisco services access requirements

The following network connectivity requirements apply to both the North American (us-east-1) and EMEA (eu-central-1) regions. The Cisco services (\*.cisco.com) to which Intersight must have access (directly or through a proxy) are listed in Table 3.

**Table 3.** Service access URLs

Cisco Service	Description	Target Device
tools.cisco.com:443	Access to Cisco Smart Licensing Manager	Required for all servers
download-ssc.cisco.com*, dl.cisco.com, dl1.cisco.com, dl2.cisco.com	Access to Cisco Software download site	Required for the following: <ul style="list-style-type: none"><li>• C-Series Standalone Servers</li><li>• UCSM-managed B-Series and C-Series servers</li><li>• UCSM-managed fabric interconnects</li></ul> UCSM-managed fabric interconnects-attached Cisco UCS S3260 Chassis
api.cisco.com:443		
cloudsso.cisco.com:443		

## Endpoint URLs required to claim targets

To claim a target, access to the North American (us-east-1) endpoints is required. If the target is claimed by an EMEA account. Access to the EMEA (eu-central-1) URLs is also required.

- **North American accounts:** North American accounts require access to all North American endpoints before and after claiming targets.
- **EMEA accounts:** targets for EMEA accounts require access to the North American endpoints so they can be claimed. After the target is claimed, only access to the EMEA endpoints is required.

**Table 4.** Endpoint URL requirements for device connectors

Region	Location name	Service URL	URLs required by device connectors
North America	intersight-aws-us-east-1	intersight.com us-east-1.intersight.com	svc.intersight.com svc.us-east-1.intersight.com svc-static1.intersight.com ucs-connect.com
EMEA	intersight-aws-eu-central-1	eu-central-1.intersight.com	svc.eu-central-1.intersight.com svc-static1.eu-central-1.intersight.com

## Configuring network ACLs in your security devices

Use `svc.intersight.com` or `svc.eu-central-1-static1.intersight.com` to configure your network ACLs when the security device supports DNS names or use IP addresses when the security device does not support DNS names. IP addresses may change over time. You can obtain the list of IP addresses by retrieving the DNS A records for `svc.intersight.com` or `svc.eu-central-1-static1.intersight.com`, available publicly in the DNS system. For example, on a Linux system type:

```
dig svc.intersight.com
```

or

```
dig svc.eu-central-1-static1.intersight.com
```

look for the answer section. The following is an example of the answer section.

```
svc.intersight.com. 5    IN    A     aa.aaa.aaa.aaa
svc.intersight.com. 5    IN    A     aa.aaa.aaa.aaa
svc.intersight.com. 5    IN    A     aa.aaa.aaa.aaa
```

The A records do not change frequently but may change over long periods; therefore, a periodic refresh of the configuration is required.

---

## Configuring HTTPS proxy

An explicit HTTPS proxy acts as an intermediary for messages exchanged between the device connector and external services. The proxy must support the HTTP CONNECT method to set up forwarding of arbitrary data through the connection. To establish a connection to `svc.intersight.com` or `svc.eu-central-1-static1.intersight.com`, the device connector connects to the proxy and sends using the HTTP CONNECT method. The proxy forwards all the traffic between the device connector and external services without modifying the TLS handshake; hence, no certificate configuration is required. Use the following steps to configure the hostname or IP address of the explicit proxy in the device connector UI:

- In the Proxy Configuration tab on the device connector UI, slide the HTTPS Proxy option to ON.
- Enter the proxy hostname or IP address.
- Enter a proxy port.
- Add a username and password for authentication.

## Default passwords

The password-strength option is enabled by default in all management modes. Strong passwords must meet the following requirements:

- Must contain a minimum of 8 characters and a maximum of 64 characters
- Must contain at least three of the following:
  - Lowercase letters
  - Uppercase letters
  - Numbers
  - Special characters
- Must not contain a character that is repeated more than three times consecutively (for example, a password containing “aaabb” would be acceptable, but “aaaabbbb” would not).
- Must not be identical to the username or the reverse of the username
- Must pass a password dictionary check. For example, the password must not be based on a standard dictionary word.
- Must not contain the following symbols: \$ (dollar sign), ? (question mark), or = (equals sign)
- Should not be blank for local user and admin accounts

Additional password profile options:

- Change count: maximum times a password can be changed within the change interval
- Change interval: time frame used by the change count
- No-change interval: minimum hours a local user must wait before changing newly created password
- Change during interval: capability to change the password during the change interval

After deployment and initial configuration are complete, make sure that any default passwords are changed or updated.



## Device connector

Cisco UCS systems are connected to the Intersight SaaS platform or on-premises virtual appliance through a device connector that is embedded in the management controller of each system.

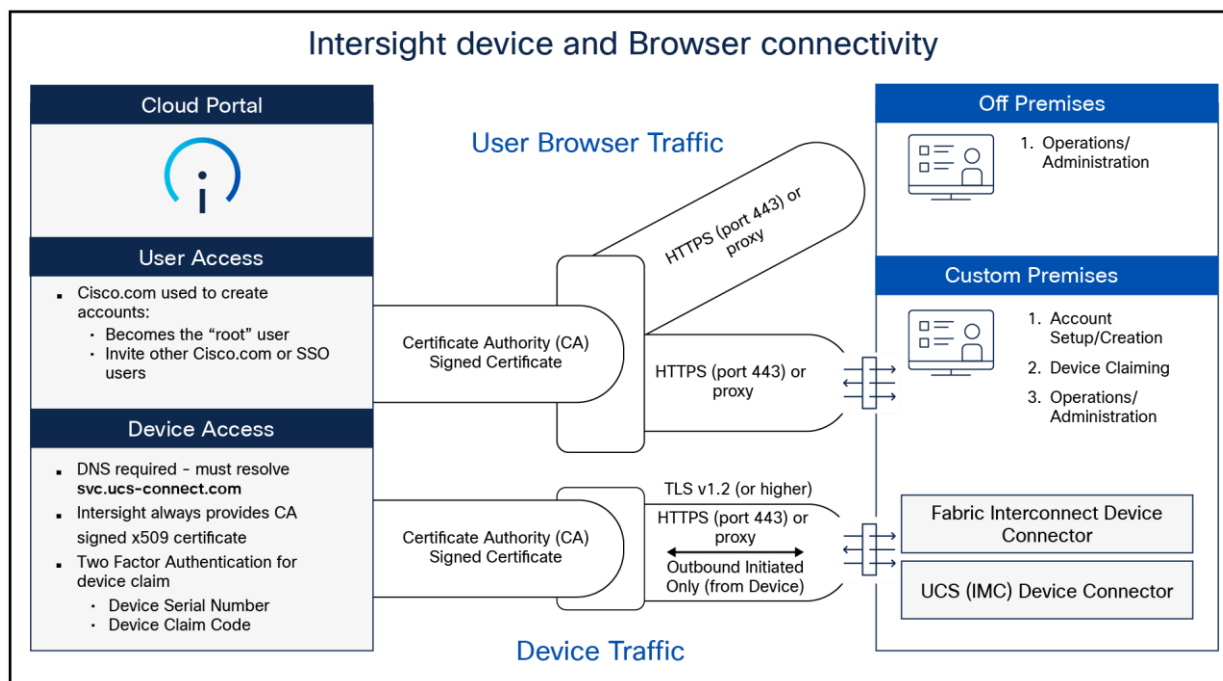

**Figure 10.** Connection to Intersight services with the Cisco UCS device connector

The Intersight platform separates user and device traffic and communicates using industry-standard HTTPS and TLS protocols.

All data exchanged between devices and the Intersight platform uses industry-standard encryption and security protocols. Connected devices use Transport Layer Security (TLS) with restricted ciphers and HTTPS on the standard HTTPS port 443. All data sent to Intersight is encrypted using the Advanced Encryption Standard (AES) with a 256-bit, randomly generated key that is distributed with a public-key mechanism. In addition, every device connection to the portal is authenticated with a cryptographic token so that only legitimate devices can be managed, thus closing a potential Trojan horse attack vector. All connections are initiated from the device. Thus, firewalls can block all incoming connection requests; only HTTPS port 443 needs to be enabled for outbound connections. As a result, firewalls do not need any other special configuration to enable Intersight connectivity. Devices can be configured to use HTTPS proxy servers to add an additional layer of security through indirection.

To help ensure connection security and prevent man-in-the-middle attacks, Cisco UCS devices connecting directly to the Intersight platform use a single-destination HTTPS URL. The platform presents a certificate signed by a Certificate Authority (CA). If an unsigned certificate is presented, the devices will not connect to the portal. Intersight software and the device connector create a secure management framework that provides real-time information related to device security. This approach also allows connected devices and Intersight software to stay synchronized with the latest connection-security updates.

---

To monitor and manage devices with the Intersight platform, they first must be claimed from an Intersight account. Devices can be claimed using a browser by going to the SaaS or virtual appliance portal and clicking on the Claim Devices tab. Device IDs and a claim code, both of which are unique to the device, are retrieved from the device.

You can find the device ID and claim code through the device's local management interface. The claim code is refreshed every 10 minutes as an additional safeguard to ensure that the administrator claiming the device has physical access to it. Two-factor authentication is used to verify the identity and authenticity of each device being claimed. This authentication mechanism adds another layer of security to the device-claiming process. It requires access to the device as well as device identification information that is validated against your Intersight account.

If an unauthorized user guesses or learns device information, the user cannot claim a device without physical access to the device.

## Cisco Intersight Assist

Cisco Intersight Assist is a virtual machine that you can deploy in your data-center environment to streamline some Intersight device-connection options. Intersight Assist helps you add endpoint devices to Cisco Intersight. A data center can have multiple devices that do not connect directly with Cisco Intersight. Any device that is supported by Cisco Intersight, but does not connect directly with it, will need a connection mechanism. Cisco Intersight Assist provides that connection mechanism and helps securely connect local data-center resources (VMware, storage, networking, etc.) to Cisco Intersight.

Cisco Intersight Assist helps you add endpoint devices to Cisco Intersight. A data center could have multiple devices that do not connect directly with Cisco Intersight. Any device that is supported by Cisco Intersight but does not connect directly with it, will need a connection mechanism. Cisco Intersight Assist provides that connection mechanism and helps you add devices to Cisco Intersight.

Cisco Intersight Assist enables Cisco Intersight to communicate with targets that do not have a direct path to Cisco Intersight and do not have an embedded Intersight device connector. These include targets such as storage devices, hypervisor managers, application performance management products, and much more. Intersight Assist communicates with the target's native APIs and serves as the communication bridge to and from Cisco Intersight. Intersight Assist services run as a standalone appliance when used with Cisco Intersight SaaS. For the Intersight Connected Virtual Appliance and Private Virtual Appliance, a separate Assist Appliance is not needed because the services are collocated.

You can view the Intersight Assist details by navigating to **Appliance UI > Target**. You can choose to install Cisco Intersight Assist from the installer during the set-up wizard. It can be installed on an ESXi server, a Kernel-Based Virtual Machine (KVM), or a Hyper-V Hypervisor.

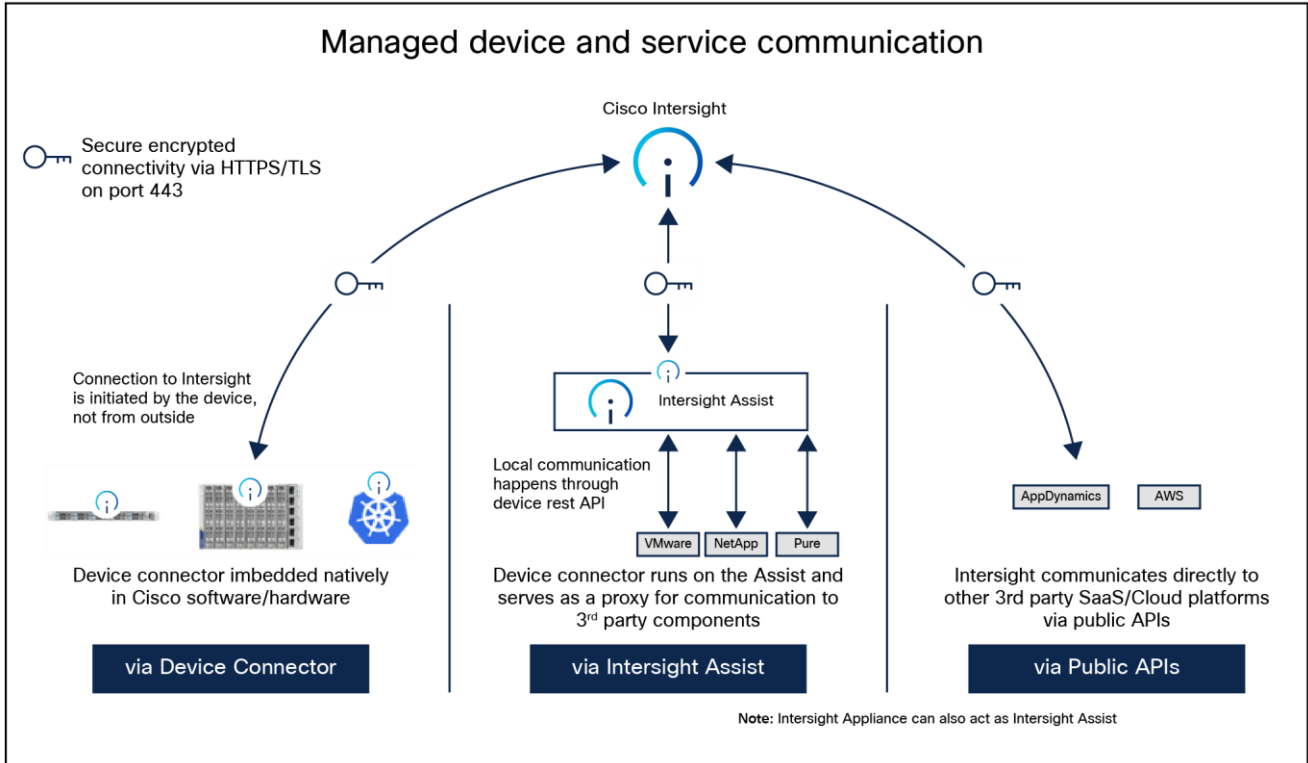

**Figure 11.**  
Managed device and service communications to Intersight

### Configure fabric interconnects for Cisco Intersight management

During initial configuration of a fabric interconnect-based UCS system, you are given the option to run in UCSM mode (UMM) or Intersight Managed Mode (IMM). For Cisco UCS X-Series systems, IMM is the only supported mode.

Here we cover fabric-interconnect configuration for IMM and the appropriate selections for getting the system set up with secure passwords and updating the firmware to remediate any known bugs or CVEs. Depending on the state of each fabric interconnect, this first set of steps may not be necessary. If you see a message “Switch can now be configured from GUI,” as shown in the following image, you must follow these steps:

```
This setup utility will guide you through the basic configuration of
the system. Only minimal configuration including IP connectivity to
the Fabric interconnect and its clustering mode is performed through th
ese steps.

Type Ctrl-C at any time to abort configuration and reboot system.
To back track or make modifications to already entered values,
complete input till end of section and answer no when prompted
to apply configuration.

first-setup: Warning: is EMPTY, using switch as name

Starting GUI for initial setup.

Switch can now be configured from GUI. Use https://          and
click
on 'Express Setup' link. If you want to cancel the configuration from
GUI and go back
press the 'ctrl+c' key and choose 'X'. Press any other key to see the
installation progress from GUI
Note: Intersight management mode setup available through console based
configuration method alone.
```

**Figure 12.**  
IMM configuration from console

Press **CTRL-c**, as instructed on the screen, to halt the GUI configuration process. You can configure Cisco intersight mode only through the console.

Next, type **“X”** followed by Enter. Because of screen wrapping, you may not be able to see the **“X.”**

```
Note: Intersight management mode setup available through console based
configuration method alone.

Type 'reboot' to abort configuration and reboot system
or Type 'X' to cancel GUI configuratuion and go back to console or Pre
ss any other key to see the installation progress from GUI (reboot/X) ?

Enter the configuration method. (console/gui) ? console
Enter the management mode. (ucsm/intersight)? intersight

You have chosen to setup a new Fabric interconnect in "intersight" mana
ged mode. Continue? (y/n) y

Enforce strong password? (y/n) [y]: y

Enter the password for "admin":
Confirm the password for "admin": Internal CLI error: Invalid argument

Enter the switch fabric (A/B) [] A

Enter the system name: █
```

**Figure 13.**  
IMM configuration from console part 2

- 
- You will be asked to enter the configuration method. You can configure Cisco Intersight mode only through the console. Type “console”.
  - For the management mode, type “Intersight”.
  - The wizard will ask you to confirm that you are setting up a new fabric interconnect in Intersight Managed Mode. Type “y” to confirm.
  - You will be asked whether to enforce strong passwords. Select to enforce strong passwords and enter the password.

Next, configure the switch fabric.

- For the switch fabric (A or B), choose “A”.
- Name the system. (Note that the name assigned to the system in this step will be applied to every chassis and server connected to it. This name cannot be changed later without erasing the fabric interconnect configuration.)
- Enter the IP address for fabric interconnect A.
- Enter the netmask for the management network.
- Enter the default gateway for the management network.
- Enter the IP address of the Domain Name System (DNS) servers.
- Configure the default domain name.

The last step is to confirm your settings. Verify that your settings are correct and type “yes” to continue. It will take several minutes for the fabric interconnect to reboot. Before configuring the second fabric interconnect, wait until fabric interconnect A fully reboots. Once the first fabric interconnect has rebooted, the second fabric interconnect will be able to detect the first fabric interconnect’s presence and will allow its configuration as a cluster. Proceed to the next section to configure the second fabric interconnect.

You may need to hit the Enter key to wake up the console for fabric interconnect B (FI-B). If you see nothing on the screen, the fabric interconnect is waiting for you either to configure it from the GUI or to press CTRL-c to interrupt the process. Just as you did for the fabric interconnect-A setup, press CTRL-c.

- Type “X” and then Enter.
- Enter “console” for the configuration method.
- Fabric interconnect B should detect that its peer (fabric interconnect A) is already configured and will ask if it should attempt to join that cluster. Type “y” and hit Enter.
- Enter the password you used for fabric interconnect A .

At this point, fabric interconnect B will pull the networking configuration from its peer. You only need to provide fabric interconnect B with an IP address.

Type “yes” to save the configuration and restart the fabric interconnect.

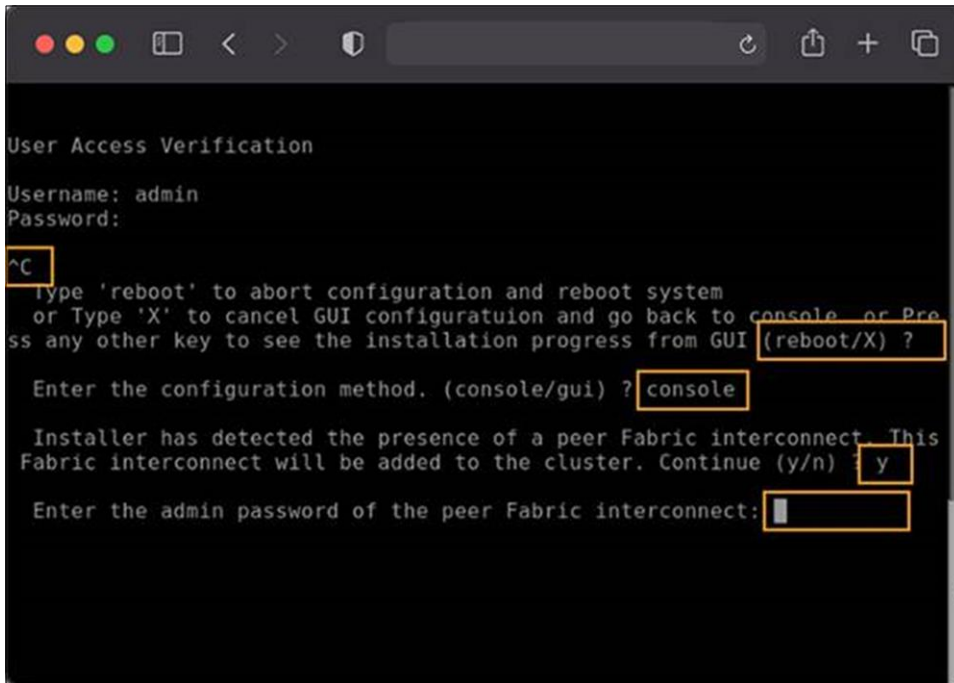

**Figure 14.**  
IMM configuration from console part 3

### Multifactor claim process for fabric interconnects in the Cisco Intersight platform

Next, the system needs to be claimed in Intersight. Connect to the device console on the fabric interconnect pair. There is no longer an instance of Cisco UCS Manager, and when you browse to one of the fabric interconnects, you will be prompted to log into the device console instead. This console is where you obtain a device ID and claim code to claim this new domain in the Cisco Intersight platform.

Using a browser, connect the IP address of fabric interconnect. Ensure that HTTPS is used, or you will not be able to connect to the device console. Log in with the credentials you configured earlier during the fabric interconnect setup.



**Figure 15.**  
Device console log in

Select the Device Connector tab. If there is an error on this page saying, “Some unknown internal error has occurred,” it is likely because this domain has been claimed in Cisco Intersight already. Click the refresh button in the device connector view. If the problem persists, contact Cisco® Technical Assistance Center (Cisco TAC) to address this problem. If, instead, you see a screen like the one shown below, which shows that the fabric interconnect can connect to Cisco Intersight but is not yet claimed, then proceed to the next step.

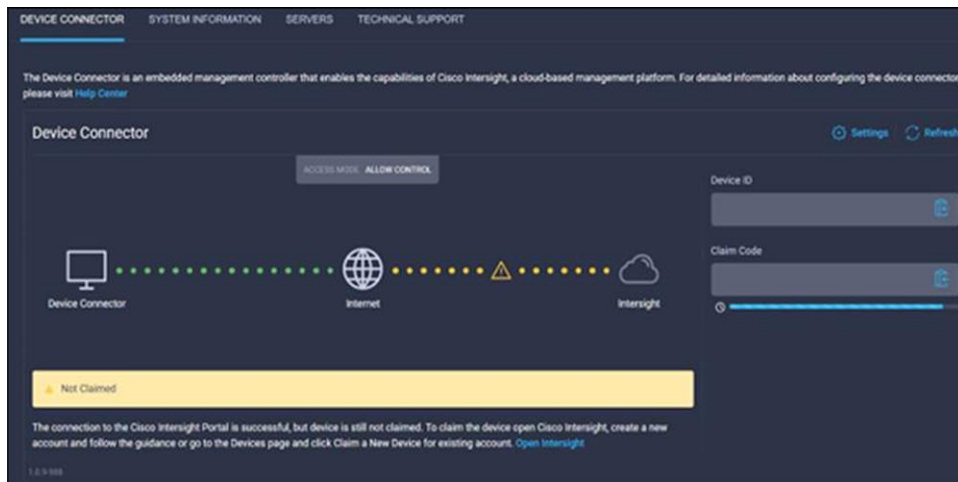

**Figure 16.**  
Connect the fabric interconnects to Intersight

Browse to [intersight.com](https://intersight.com) from your computer. Use your Cisco Intersight credentials for an account that has at least the “Device Technician” role. The roles “Device Technician” and “Device Administrator” allow you to claim and unclaim devices. Once authenticated, make sure you have selected “System” from the top drop-down menu, as shown below:

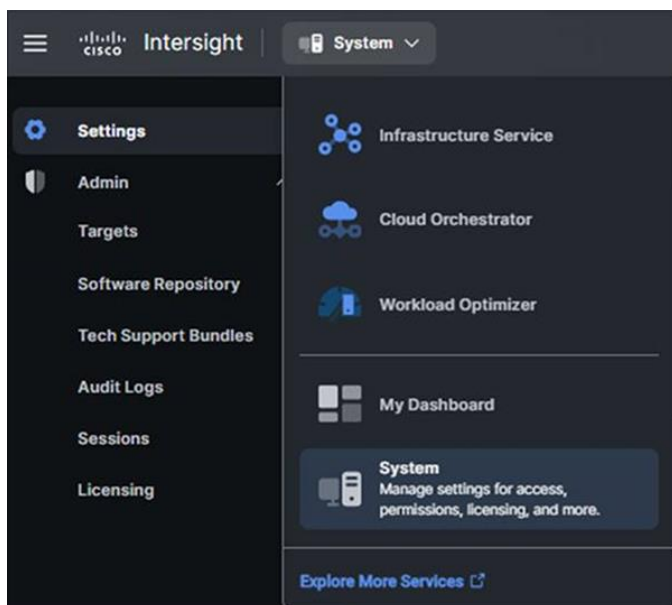

**Figure 17.**  
System view when claiming a device

- Select “Admin -> Targets” and then click the blue “Claim a New Target” button in the upper-righthand portion of the window.
- For target type, select “Cisco UCS Domain (Intersight Managed)” and click the “Start” button.
- Enter the device ID and claim code from the Device Console.
- Click the blue “Claim” button after pasting the device ID and claim code. Shortly after the claim succeeds, the fabric interconnect device connector should show a status of “Claimed,” as shown in the following image:

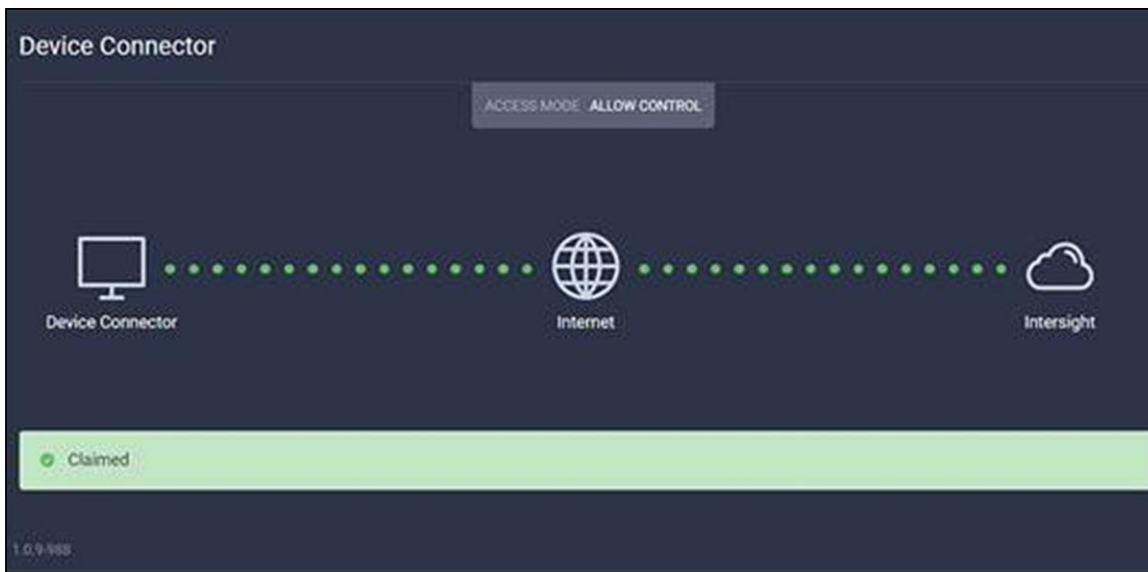

**Figure 18.**  
Device claimed

Although the “Device Technician” role can claim a target, the Device Technician cannot put that target into the right Intersight organization. Only an Account Administrator can do that. If your credentials do not have that privilege level, please reach out to someone within the Intersight organization who has Account Administrator credentials.

After the domain is claimed to Intersight, all configuration steps for servers, chassis, and fabric interconnects are initiated through Intersight. For more information about Intersight-managed domains, refer to the [Cisco Intersight Managed Mode Configuration Guide](#).

### Cisco Intersight Managed Mode Transition Tool

Cisco Intersight Managed Mode (IMM) Transition Tool helps bootstrap new IMM deployments by replicating the configuration attributes of existing Cisco UCS Manager (UCSM) and Cisco UCS Central infrastructure and by converting the existing service profiles and templates to IMM server profiles and templates to accelerate deployment of new servers and to migrate existing servers to Intersight Managed Mode.

The IMM Transition Tool can also be used to clone configurations between Intersight accounts, including SaaS, Connected Virtual Appliance, and Private Virtual Appliance. IMM Transition Tool Release 3.0.1 and later provides support for preserving the configuration identifiers that a physical server gets from a server profile. These include IP addresses, MAC addresses, iSCSI Qualified Names (IQNs), Universal Unique Identifiers (UUIDs), World-Wide Node Name (WWNNs), and (World-Wide Port Names (WWPNs). This support enables the migration of service profiles from UCS Manager/Central to IMM.



---

With IMM Transition Tool Release 4.0.1 onward, you can use the software repository feature to install operating-systems and upgrade firmware on your servers.

IMM Transition Tool offers the following functionality:

- Ability to validate hardware compatibility for Cisco UCS Manager domain
- Fetching an entire configuration from a running UCS Manager domain or UCS Central instance
- Ability to validate what part of the configuration is available in Intersight
- Performing conversion of UCS Manager or UCS Central configuration attributes to IMM
  - Conversion of the running configuration of the UCS Manager domain is primarily done in two parts (you can selectively enable or disable each section for configuration conversion):
    - Convert the fabric configuration of the UCS Manager domain, including VLANs/VLAN Groups/VSANs, Port roles, QoS, and administrative settings (NTP/DNS/SNMP/SYSLOG)
    - Convert the service profiles and service profile templates from the UCS Manager domain and all the attached policies
  - Conversion of the running configuration of the UCS Central instance is primarily done as follows (you can selectively enable or disable each section for configuration conversion):
    - Convert the service profiles and service profile templates from the UCS Central instance and all the attached policies.

## Access methods to management and configuration interfaces

The management plane consists of functions that achieve the management goals of the system. Any management function undertaken by the user must rely on interaction through secure protocols. This is handled through HTTPS for any Intersight UI access. Authenticated, tokenized access is used for in-house development through APIs. Management security also entails role-based access control as well as auditing and logging of system activities and user input, all of which are incorporated into every management mechanism.

Single Sign-On (SSO) authentication enables you to use a single set of credentials to log into multiple applications. With SSO, you can log into Intersight with your corporate credentials instead of your Cisco ID. Intersight supports SSO through SAML 2.0, acts as a Service Provider (SP), and enables integration with Identity Providers (IdPs) for SSO authentication.

## Multifactor Authentication (MFA)

With the implementation of Cisco Duo, multifactor authentication is performed through a Duo-authentication proxy, which is an on-premises software service that receives authentication requests from your local devices and applications through RADIUS or LDAP. It optionally performs primary authentication against an LDAP directory or RADIUS authentication server and then contacts Duo to perform secondary authentication. Once the user approves the two-factor request, which is received as a push notification from Duo Mobile, or as a phone call or other notification, the Duo proxy returns access approval to the device or application that requested authentication.

---

## Single sign-on with Intersight

Single Sign-On (SSO) authentication enables you to use a single set of credentials to log into multiple applications. With SSO, you can log into Intersight with your corporate credentials instead of your Cisco ID. Intersight supports SSO through SAML 2.0, acts as a Service Provider (SP), and enables integration with identity providers (IdPs) for SSO authentication. User authentication and role-based access control Intersight accounts form the authentication domain for users. The accounts control all resource access, and authenticated users are restricted from seeing any data in accounts where they are not authorized. With the SaaS platform, Cisco login IDs can be used for authentication with the identity provider for Cisco.com, which includes support for multifactor authentication. Both SaaS and on-premises Intersight implementations allow integration with external identity management systems to meet existing customer authentication requirements.

The Cisco Intersight framework uses granular access control with privileges managed per resource. Intersight software allows configuration of users and groups into several roles, and each user or group can be a member of multiple roles. Roles implemented include the following privileges:

- Account administrator: full control and management capabilities for the Cisco Intersight account and devices under management
- Read-only: read-only visibility to resources under management
- Device technician: administrative device actions including device claim to a Cisco Intersight account
- Device administrator: administrative device actions including device delete from a Cisco Intersight account
- Server administrator: server lifecycle and policy-based management
- User access administrator: user, group, and identity-provider configuration

### **What management interfaces are available after IMM for FI based systems?**

Once your system is configured for Intersight Managed Mode, the UI for UCSM is not available. The fabric interconnect management IP and the server CIMC have only rudimentary SSH console access for troubleshooting purposes.

### **What interfaces are available for UCS standalone servers claimed by Intersight?**

A UCS server in standalone mode, with no fabric interconnects, is technically not in Intersight Managed mode even if it is claimed by Intersight and managed therein. While management is still possible through Intersight, the server IMC is still available for direct UI access and SSH for management. It is recommended to choose only one management method in these scenarios to avoid any potential conflicts.

## User management

### Authentication domains

Intersight accounts form the authentication domain for users. The accounts control all resource access, and authenticated users are restricted from seeing any data in accounts where they are not authorized. With the SaaS platform, Cisco login IDs can be used for authentication with the identity provider for Cisco.com, which includes support for multifactor authentication. Both SaaS and on-premises Intersight implementations allow integration with external identity management systems to meet existing customer authentication requirements.

For the latest list of identity providers validated by Intersight, see [Supported Systems](#). For more information on the SAML support provided by the Intersight SP, see [Single Sign-On with Intersight](#).

### Resource groups, organizations, roles

Privileges on endpoints are hierarchical based on user role, from a resource group, to organization, to individual user. The top-level distinction is resource groups, which are collections of managed resources; that is, target endpoints that have been claimed in the Intersight service.

Resource groups are divided between organizations in Intersight. This allows access and control by user domain and enables multitenancy. User roles and privileges are functional within an organization on the assigned resources.

### Intersight Role-Based Access Control

**Resource Groups**

- Collection of managed resources (targets)

**Organizations**

- Enables multi-tenancy by placing devices into logical separated resource groups

**Roles and Privileges**

- System defined or user defined roles
- Roles are tied to sets of privileges to perform operations specific to a role
- Privileges can be based on areas of responsibility
  - UCS Domain, Virtualization, Storage, Network

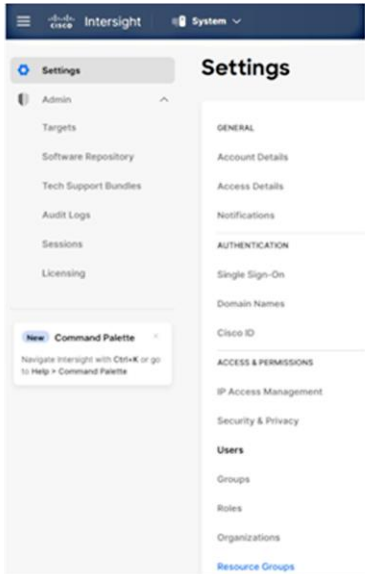

The screenshot shows the Intersight user interface. The top navigation bar includes the Intersight logo and a 'System' dropdown menu. Below the navigation bar, there is a 'Settings' section with a left-hand sidebar containing menu items: Admin, Targets, Software Repository, Tech Support Bundles, Audit Logs, Sessions, and Licensing. The main content area is titled 'Settings' and is divided into several sections: GENERAL (Account Details, Access Details, Notifications), AUTHENTICATION (Single Sign-On, Domain Names, Cisco ID), ACCESS & PERMISSIONS (IP Access Management, Security & Privacy), and Users (Groups, Roles, Organizations, Resource Groups). A 'Command Palette' is also visible at the bottom left of the settings area.

**Figure 19.**  
Resource groups Organizations Roles and Privileges

---

## Account types and best practices

The following is a list of best practices around account creation and assignment:

- Each account should have multiple account-administrator users to ensure continuity, in the event an account administrator loses access to their account or is otherwise unavailable.
- Each account should have at least one Cisco CCO ID configured, even if SAML/IdP is configured for access.
  - This enables users to access their account in cases when there are configuration issues that prevent logging in to Intersight using SSO.
- You can choose to use a service account as an account administrator instead of using a personal account. Activate multifactor authentication along with your Cisco ID for Intersight account access.

## Role-based access control

Intersight provides Role-Based Access Control (RBAC) to authorize or restrict system access to a user, based on user roles and privileges. A user role in Intersight represents a collection of privileges for operations that the user can perform and provides granular access to resources. Intersight provides role-based access to individual users or a set of users under resource groups.

A user represents an entity that can log into a specific role in Intersight with a Cisco ID or a single sign-on credential configured on Intersight. A user is granted write or read-only access to the required system resources only if the specific role grants the access privileges to the role. A privilege comprises a set of actions a user can perform. For example, a user with a server-administrator role can update server configurations, create and deploy a server profile, or perform server actions on the managed servers. However, the user cannot perform similar actions for a HyperFlex cluster.

A resource group represents a collection of users with a specific role, permission, and privileges to manage targets within one or more Intersight organizations. You can create multiple user groups to assign common roles and privileges to a set of users. If you make changes to a role or a privilege in a resource group, all users in the group inherit the same privileges.

A system-defined role is created by default in an account. Each system-defined role has only one privilege associated with it and allows a user to perform only a specific operation. These roles cannot be modified. For example, a device technician can only claim a target, but not perform any other operation.

A user-defined role is created to assign multiple privileges to a user to perform different operations. These roles can be modified by an administrator as required. For example, you can create a user-defined role named device user and assign both device-administrator and server-administrator privileges. The user can now perform both target-claim and server operations. To create a user-defined role, use the Create Role wizard.

**Note:** Only users with account-administrator or user-access-administrator privileges can create a user-defined role.

The Cisco Intersight framework uses granular access control with privileges managed per resource. Intersight software allows configuration of users and groups into several roles, and each user or group can be a member of multiple roles. Roles implemented include the following privileges:

- Account administrator: full control and management capabilities for the Cisco Intersight account and devices under management
- Read-only: read-only visibility to resources under management
- Device technician: administrative device actions, including claiming a device to a Cisco Intersight account
- Device administrator: administrative device actions, including deleting a device from a Cisco Intersight account
- Server administrator: server lifecycle and policy-based management
- User access administrator: user and identity-provider configuration. Please see the Intersight help pages for specifics on managing roles and resources.

## Adjusting account details

Account settings can be adjusted by selecting the user (person) symbol in the top right of the Intersight UI and then selecting the account in the drop-down menu. You will be taken to a settings UI where you can press the “Configure” button in the top right to adjust various account settings to keep in line with your company security policies for idle timeout, maximum sessions per user, etc.

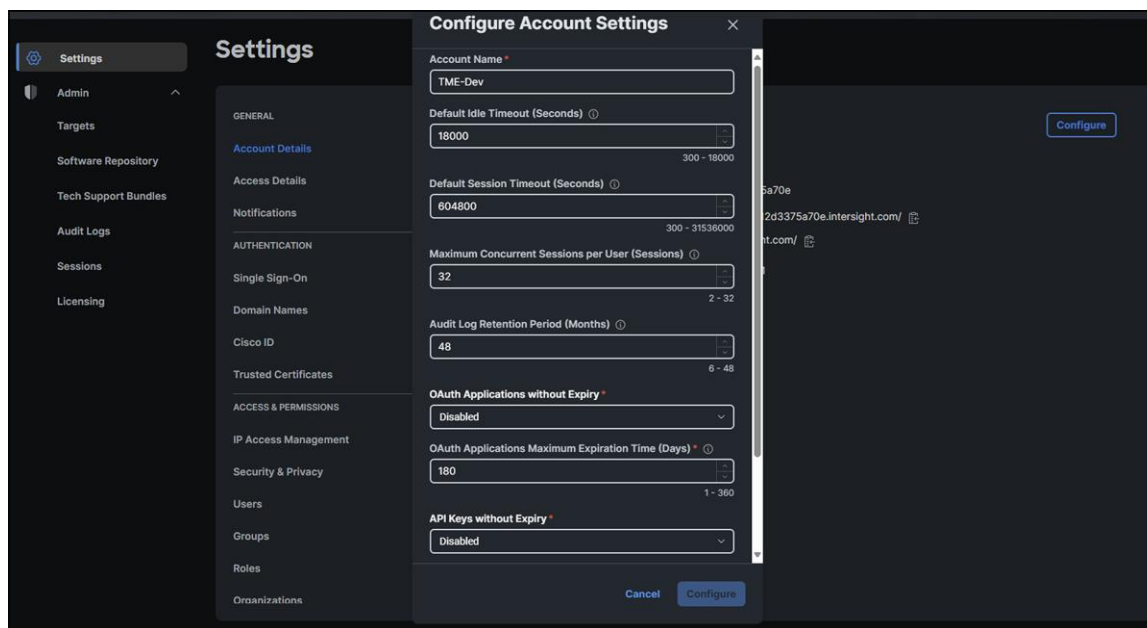

**Figure 20.**  
Adjust account session and other security settings

---

## Management at scale

### Through policy we get security enforcement

Intersight provides various policies that help enforce a secure deployment posture within service profiles:

- **Unified port policies:** these policies define the configuration for Ethernet and Fibre Channel ports, enabling administrators to set specific security-related parameters such as VLAN settings, port channel settings, QoS (quality of service) policies, etc.
- **Server BIOS policies:** these allow administrators to configure security-related settings in the server's BIOS, such as enabling or disabling specific hardware features, setting passwords, enabling secure boot, or configuring Trusted Platform Module (TPM) settings.
- **Local disk configuration policies:** these govern how local disks are configured, encrypted, or formatted, providing security measures for data stored on local disks.
- **Boot security policies:** these control boot-related security settings, including secure-boot configurations and control over boot devices.
- **Maintenance policies:** these define maintenance windows and policies that can help enforce security-related updates or configurations during specified maintenance periods.
- **Role-Based Access Control (RBAC):** this allows administrators to define roles and privileges, ensuring that only authorized personnel have access to critical functions and configurations, enhancing security by limiting access based on job responsibilities.

By utilizing these policies within Intersight when creating and managing server profiles, organizations can establish a more secure deployment posture, ensuring that servers are provisioned and configured according to predefined security best practices and policies. This helps in reducing potential vulnerabilities and maintaining a standardized and secure computing environment within the Cisco UCS infrastructure.

To use a policy in a server profile:

1. Create or edit an existing server profile.
2. Click on the “Policies” tab.
3. Select an existing policy from the list or create a new one by clicking “Create Policy.”
4. Configure the policy settings as needed.
5. Apply the policy to the server profile by clicking “Assign Policy.”

Once you have assigned a policy to a server profile, Intersight will automatically apply the configuration settings to the server. You can also use policies to stage changes and then activate them at a later stage.

The benefits of using policies in server profiles include:

- **Consistency:** ensure that multiple servers have the same configuration settings
- **Efficiency:** apply configurations to multiple servers with a single policy assignment
- **Flexibility:** easily modify or update a policy and apply it to multiple servers

When logged into the Intersight UI, select “Infrastructure Service” from the top drop-down menu. In the left navigation pane, you can select “Policies.” Here you get a list of policies that have already been created. You can edit an existing policy by selecting it, or you can select the “Create Policy” button at the top right of the screen (see Figure 21) to create a new one. It is through this wizard that you will select your policy type and create policies as needed.

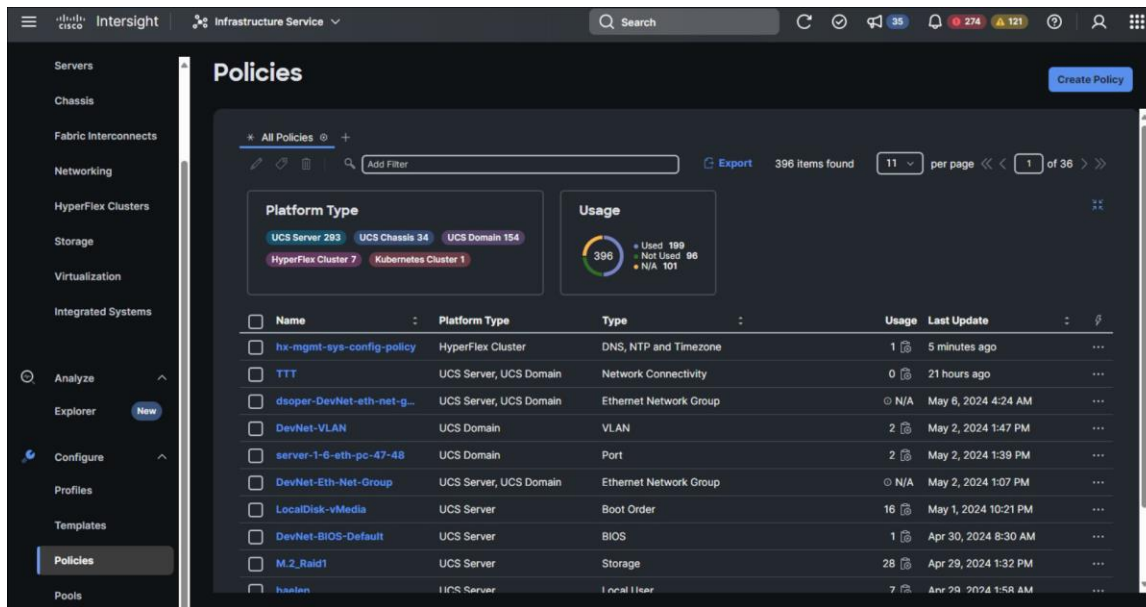

**Figure 21.**  
Policies in your organization

When creating a new policy, select the type and complete the wizard to enter the policy parameters.

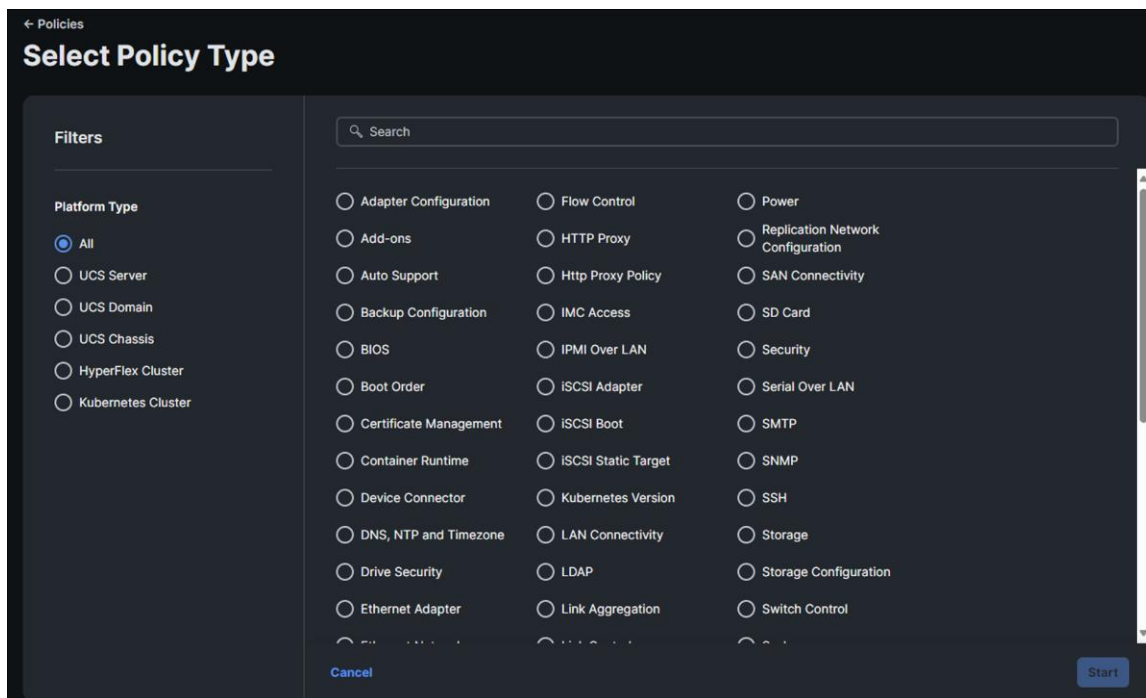

**Figure 22.**  
Select policy type

---

## Server profiles and policies in Cisco UCS with Intersight

A server profile is a software definition of a server and its LAN and SAN connectivity. The profile defines a single server and its storage and networking characteristics. It is constructed through the configuration settings defined in policies that you create. Server profiles are stored in Intersight and automatically configure the server, adapters, fabric extenders, and fabric interconnects to match the configuration specified in the service profile. This automation of device configuration reduces the number of manual steps required to configure servers, Network Interface Cards (NICs), Host Bus Adapters (HBAs), and LAN and SAN switches.

The server profile is a central component that defines the compute, network, and storage characteristics for a server within the UCS infrastructure. Essentially, it abstracts the physical hardware configuration from the logical configuration, enabling rapid provisioning, mobility, and scalability within the data-center environment. It is critical to note that policies prevent systems from being tampered with physically because changes to local settings are blocked when a policy is applied. This makes drift management nearly moot since the application of a policy prevents drift in the first place.

A server profile contains:

- **Hardware identity:** this includes details such as WWPN (World-Wide Port Name) and WWNN (World-Wide Node Name) for Fibre Channel, MAC addresses for Ethernet, BIOS settings, and firmware versions.
- **Boot policies:** these define how the server boots, which operating system it uses, and where it boots from (local disk, SAN, LAN, etc.).
- **Host firmware package:** this specifies the firmware versions to be applied to the server's components, ensuring consistency and compliance.

You can create server profiles using the server profile wizard, or you can import the configuration details of Cisco UCS C-Series servers in standalone mode and fabric-interconnect-attached servers in Intersight Managed Mode (IMM) directly from Cisco Integrated Management Controller (IMC). You can create server profiles using the server profile wizard to provision servers, create policies to ensure smooth deployment of servers, and eliminate failures that are caused by inconsistent configuration. The server profile wizard groups server policies into the following four categories to provide a quick summary view of the policies that are attached to a profile:

- **Compute policies:** BIOS, boot order, and virtual media
- **Network policies:** adapter configuration, iSCSI boot, LAN connectivity, and SAN connectivity policies
  - The LAN connectivity policy allows you to create Ethernet network policy, Ethernet network control policy, Ethernet network group policy, Ethernet adapter policy, or Ethernet QoS policy. When you attach a LAN connectivity policy to a server profile, the addresses of the MAC address pool, or the static MAC address, are automatically assigned.
- **Storage policies:** SD card and storage policies
- **Management policies:** device connector, IPMI over LAN, LDAP, local user, network connectivity, SMTP, SNMP, SSH, serial over LAN, syslog, NTP, certificate management, and virtual KVM policies



To create a server profile, select “Infrastructure Service” from the top drop-down menu in the Intersight UI. Select “Profiles” from the left menu pane. You are shown a list of existing profiles that you can edit as needed.

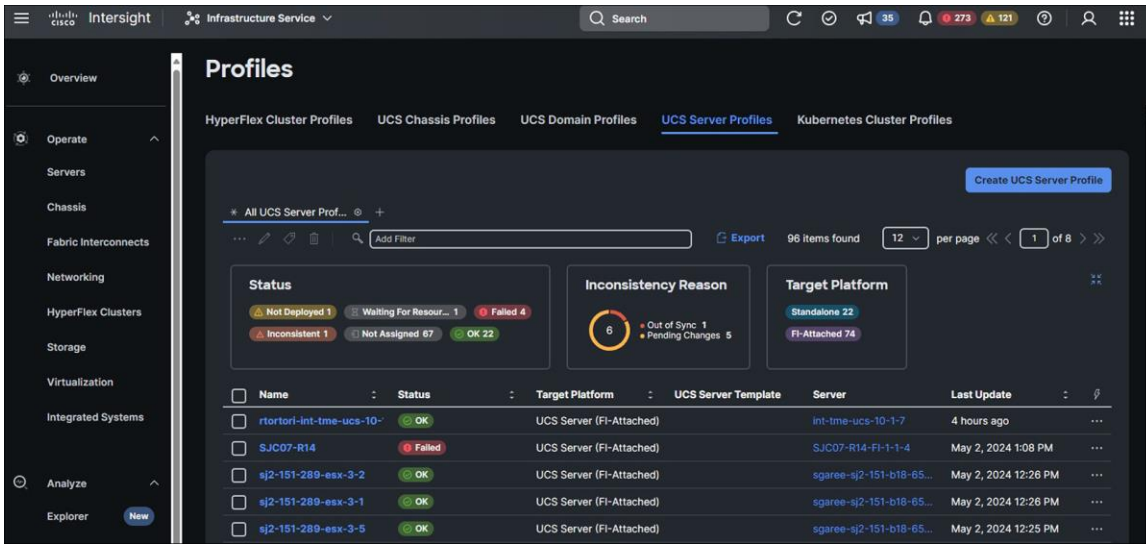

**Figure 23.**  
Profile list

You can create a new profile by clicking the “Create UCS Server Profile” button at the top right of the screen (see Figure 23).

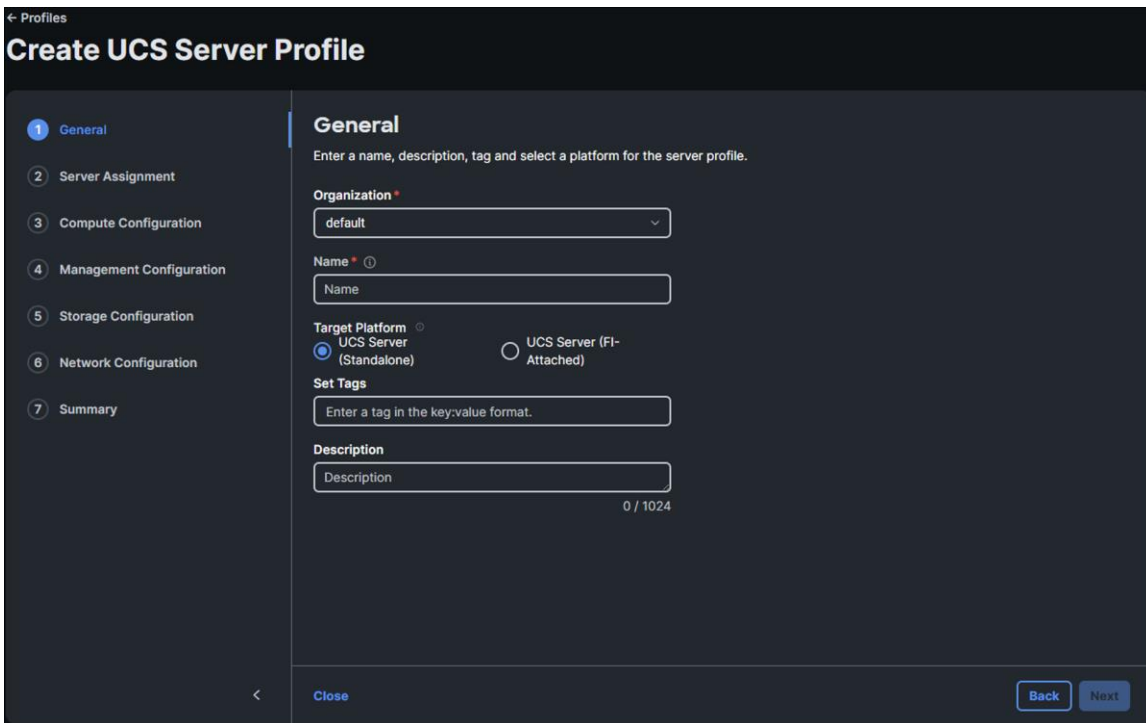

**Figure 24.**  
Create a new server profile

You can assign your profile to an existing server or bypass that step for now. You are then walked through policy categories for your profile, at which time you can assign or create policies.

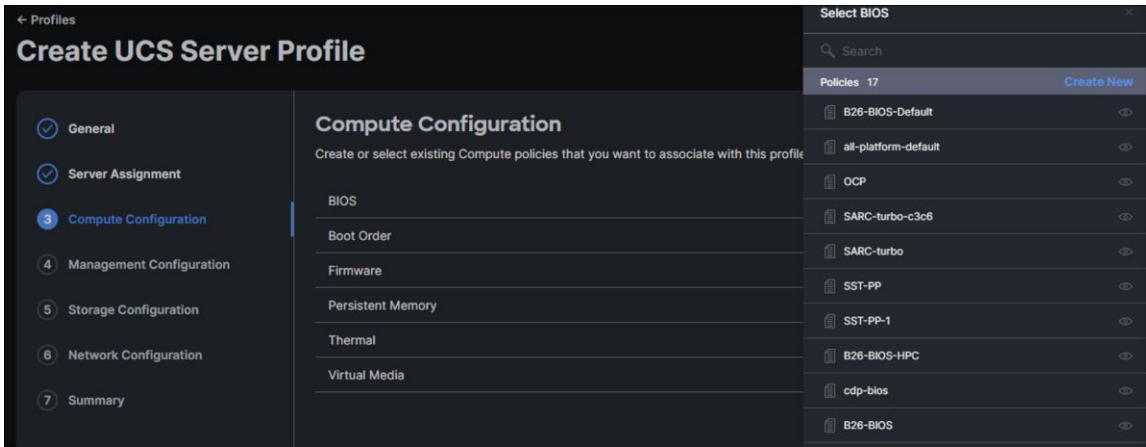

**Figure 25.**  
Assign or create a policy for compute configuration

Next you can set policies for management.

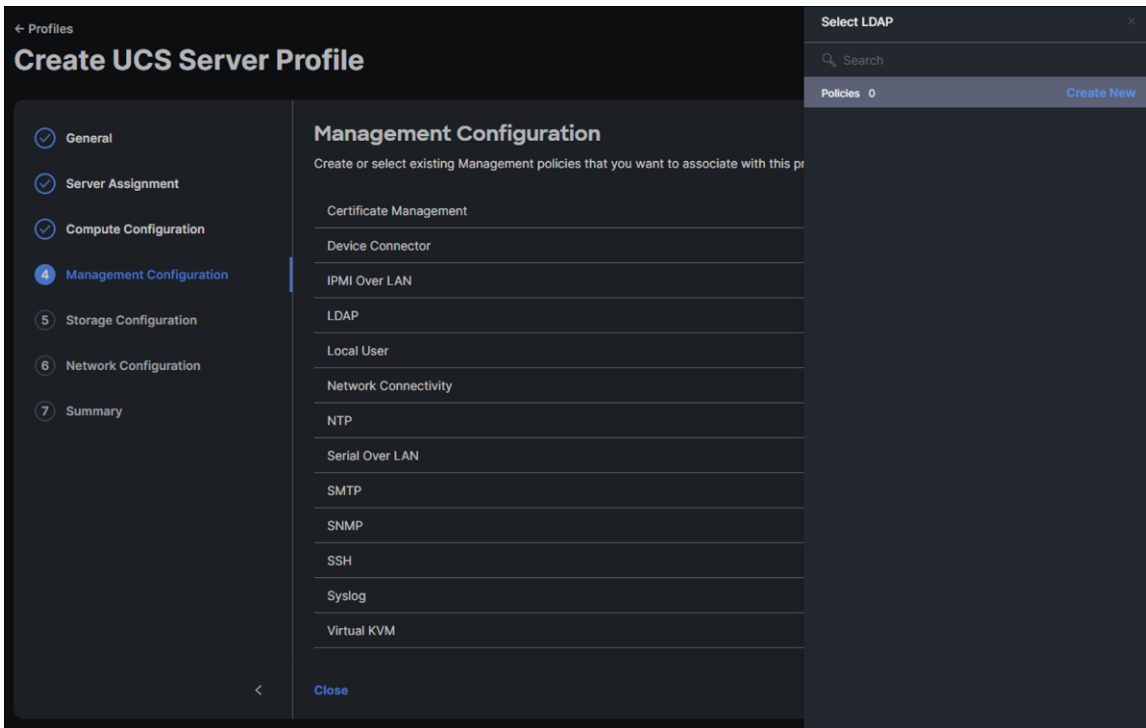

**Figure 26.**  
Set management policies

Similarly, you will set storage and network policies and then you will be presented with a summary.

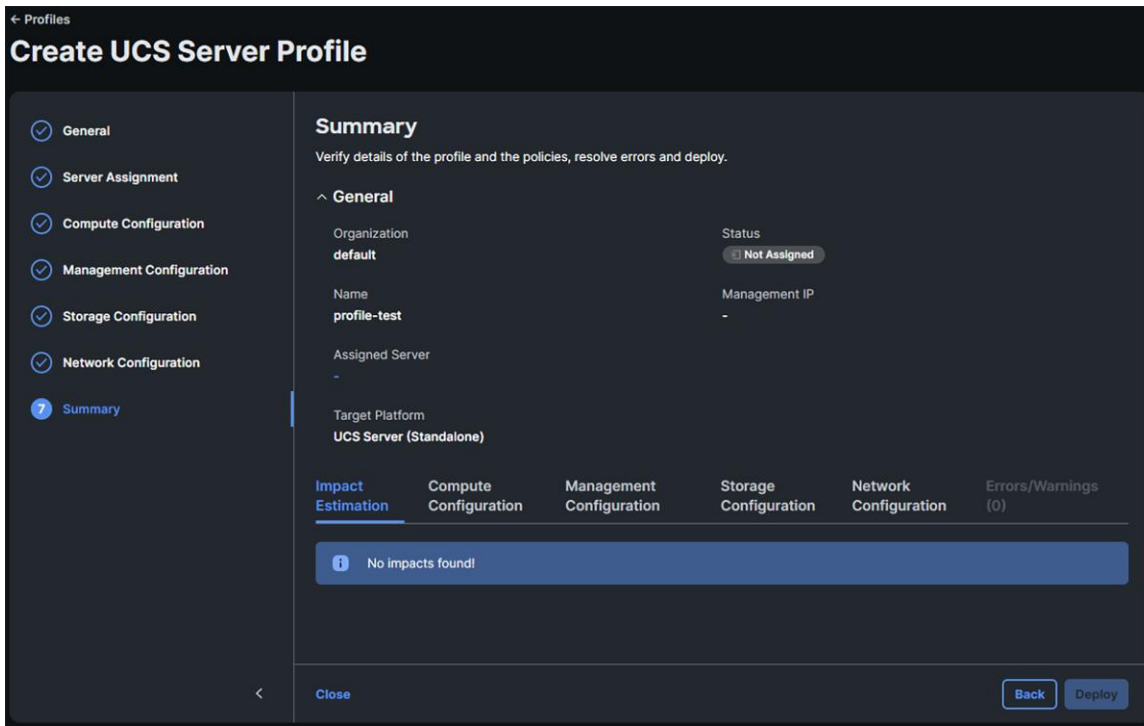
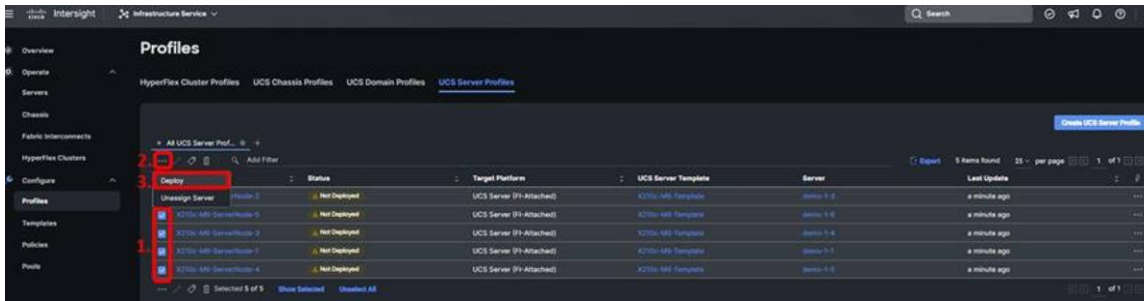

**Figure 27.**  
Profile summary

The assignment process is immediate. The profiles are **assigned** to the servers you have selected, but no configuration changes happen yet.

In Intersight, browse to “Configure -> Profiles” and select the “UCS Server Profiles” tab, and you will see that your profile(s) has been assigned to a server but shows a status of “Not Deployed.” You can select multiple profiles in this state, and click the ellipses at the top of the table to deploy them all in bulk. When you deploy a profile, Intersight will create a Request that you can monitor. Every time you make a change to a profile, or a policy associated with that profile, its state will change from “Deployed” to a state indicating changes that have been made within Intersight but have not been pushed to the server. Each time, you will have to come back to this screen and “Deploy” the profile. This behavior is different from that of Cisco UCS Manager. You can read more about the various states at: <https://intersight.com/help/saas/features/servers/configure>.

When ready to deploy the server profiles, click “Deploy” and then click “Deploy” again in the pop-up window:



**Figure 28.**  
Deploy the service profile

In an environment where you have multiple UCS domains, you can move that profile between any of those domains.

## Firmware upgrades and image downloads

There is a difference in the IMM numbering convention between Cisco UCS X-Series firmware versions and IMM infrastructure versions. For example, infrastructure might have firmware version 4.2(3a), but the Cisco UCS X-Series firmware may be listed as 5.2. The IMM server and infrastructure firmware is much less coupled than the traditional UCSM firmware, as seen in the cross-version support tables. Server firmware can be more recent than infrastructure firmware, which makes firmware management easier because server bug or CVE fixes and new servers can be updated independently without forcing infrastructure upgrades.

Image downloads for firmware or appliances are signed. There is currently no mechanism to verify the MD5 hash of downloaded software in situ. Even though the checksum is not validated for the downloaded image, the signature on the image guarantees that it is valid, unmodified, and malware free. An image with a failed signature cannot be used.

## Upgrading fabric-interconnect firmware

Before discovering what hardware is connected to the fabric interconnects, you should check to see if a recommended firmware upgrade is available for the fabric interconnects. After logging into Intersight, select the drop-down box in the upper left corner of the screen, and select “Infrastructure Service” if it is not currently selected (see Figure 29).

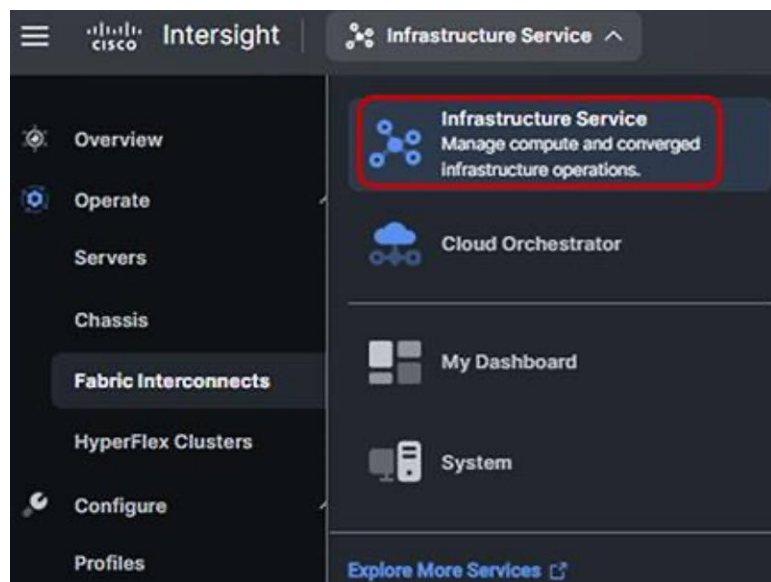

**Figure 29.**  
Selecting fabric interconnects

Select your fabric interconnect(s) from the list, click the three dots in the right column, and then select “Upgrade Firmware” from the drop-down menu.

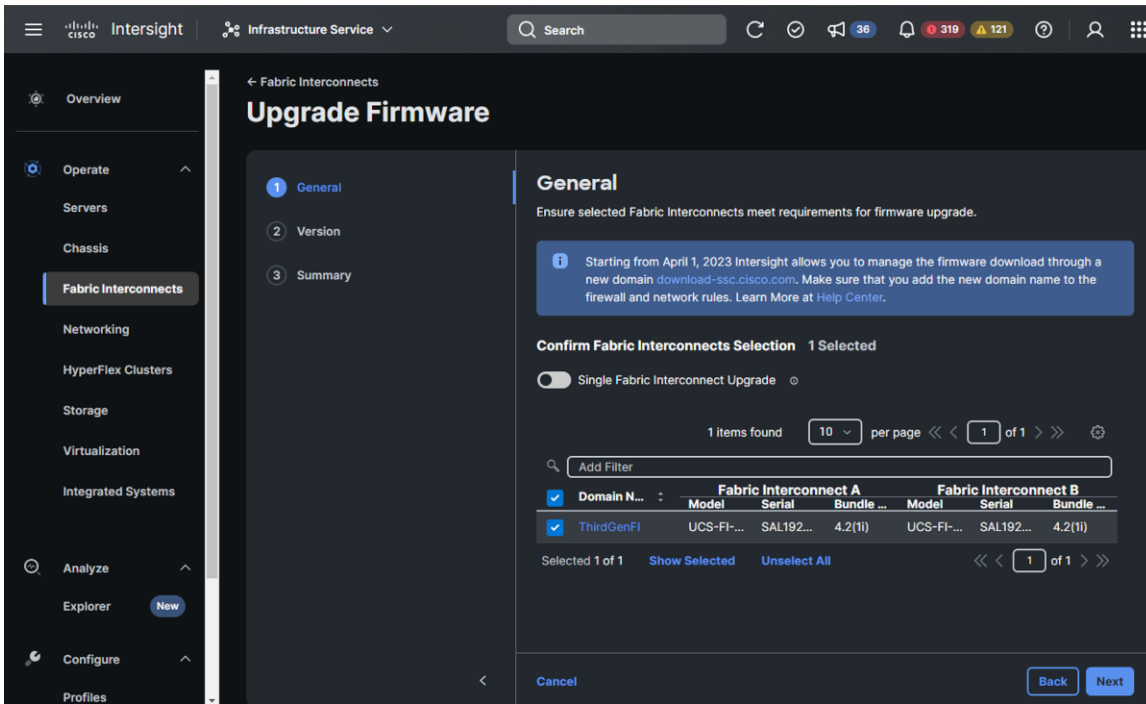

**Figure 30.**  
Select your fabric interconnect for upgrade

Click “Next”, then select your desired firmware version.

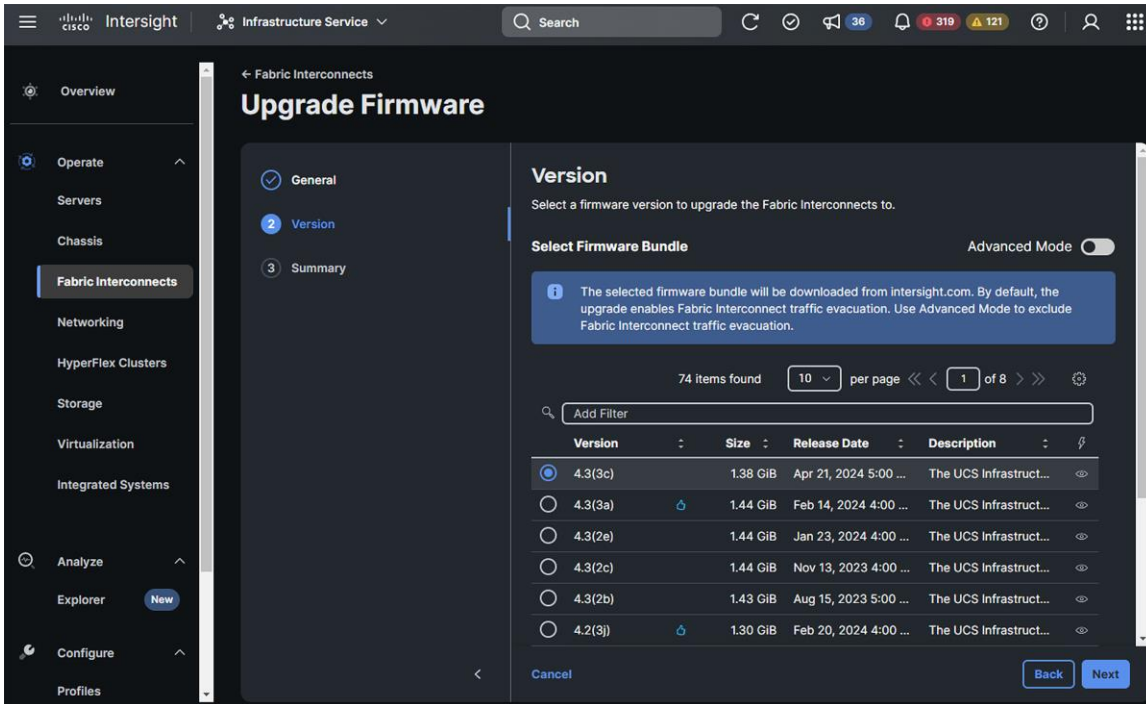
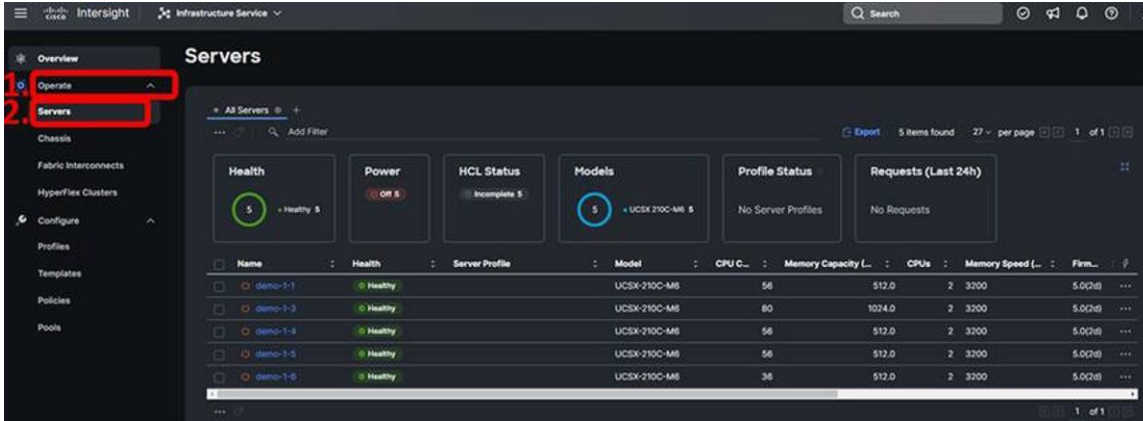

**Figure 31.**  
Choose your firmware version

Click “Next” again, then review the summary and commit the upgrade.

## Update server firmware

Intersight allows for upgrading firmware on multiple servers at once. In Intersight, browse to “Operate -> Servers”. Intersight will display the servers discovered in the domain.

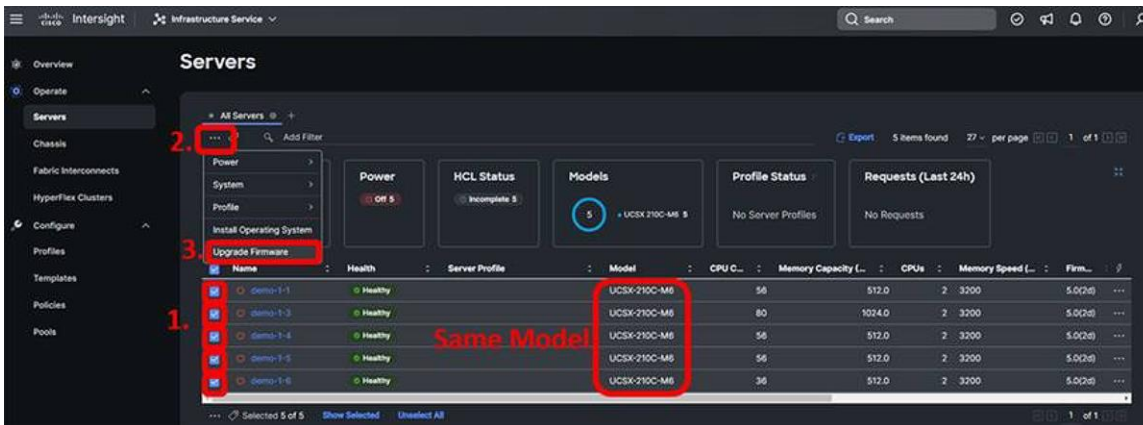

**Figure 32.**

Choose your server for firmware upgrade

Select all the discovered servers that are of the same type by clicking the checkbox next to each one. Bulk firmware upgrade operations are supported only on similar servers. You can sort the servers table by “Model” if there is any confusion.

With one or more servers selected, click the ellipses (...) at the top or bottom of the server table and choose “Upgrade Firmware” (see Figure 33).



**Figure 33.**

Select multiple of the same model to upgrade

The first step of the firmware upgrade process introduces the firmware upgrade wizard and allows you to change your mind about which servers you want to upgrade. Click “Next” to proceed.

Next, select the upgrade firmware version.

You can view firmware details by selecting the “eye” button in the right column of the firmware.

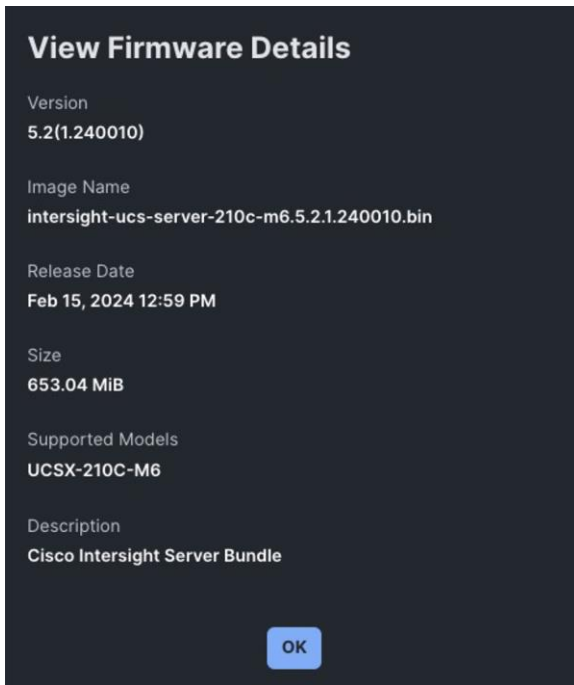

**Figure 34.**  
Firmware details

Select the radio button for the firmware version that best applies to your deployment then click “Next.” On the “Summary” page, verify that the information is correct and select “Upgrade”. Select “Reboot Immediately to Begin Upgrade” if the servers are at a state where it is safe to reboot, and click “Upgrade” again on the pop-up.

This process takes roughly 30 minutes, and the process can be monitored by selecting the active requests in the upper righthand portion of the screen.

## Intersight for API management

Cisco Intersight includes an API that supports the OpenAPI specification, a powerful definition format to describe RESTful APIs. Support for the OpenAPI specification provides access to an interoperable REST API with tools that automate the generation of the [Intersight API documentation](#), API schemas, and SDKs. The Intersight API includes fully functional Python and PowerShell SDKs. See the “Audit records, scope, and use cases” section later in this document for a brief discussion of the API browser.

The REST architecture provides access to the Intersight Management information model. API requests may be read-only queries with no side-effects, or they may produce modifications of the resources. The response may confirm that some alteration has been made to the resource, and it may provide hypertext links to related resources or collections of resources. The Intersight API accepts and returns messages that are encapsulated through JavaScript Object Notation (JSON) documents and securely uses HTTP over TLS as the transport protocol. The Intersight OpenAPI document is available with both OpenAPI schema versions 2 and 3. We recommend using the OpenAPI document based on schema version 3.

Intersight provides downloadable SDK packages in multiple programming languages. The Intersight API is automatically updated when new features are deployed to the cloud, providing programmatic access to new IT infrastructure capabilities.

## API keys

API keys are created using an Intersight account, as described in the [Intersight API Quick Start Guide](#). The Intersight Account Management (IAM) service for the account's region manages the API key creation and lifecycle.

There are region-specific target URLs for API requests, and they must be accessible from the requesting client.

- North America region: [intersight.com](https://intersight.com) and [us-east-1.intersight.com](https://us-east-1.intersight.com)
- EMEA region: [eu-central-1.intersight.com](https://eu-central-1.intersight.com)

Intersight API clients can be deployed anywhere if they have network connectivity to the Intersight service and can establish outbound HTTPs connections to the regional endpoints over TCP port 443. The Intersight API clients are not required to have network connectivity to the systems managed by Intersight. However, in some use cases such as bulk claiming devices, API clients may need connectivity to the region-specific Intersight URLs and managed systems.

You can also view the region-specific target URLs in the API documents:

1. Log into your Intersight account at <https://intersight.com>.
2. Go to “Help > Command palette > API docs”.

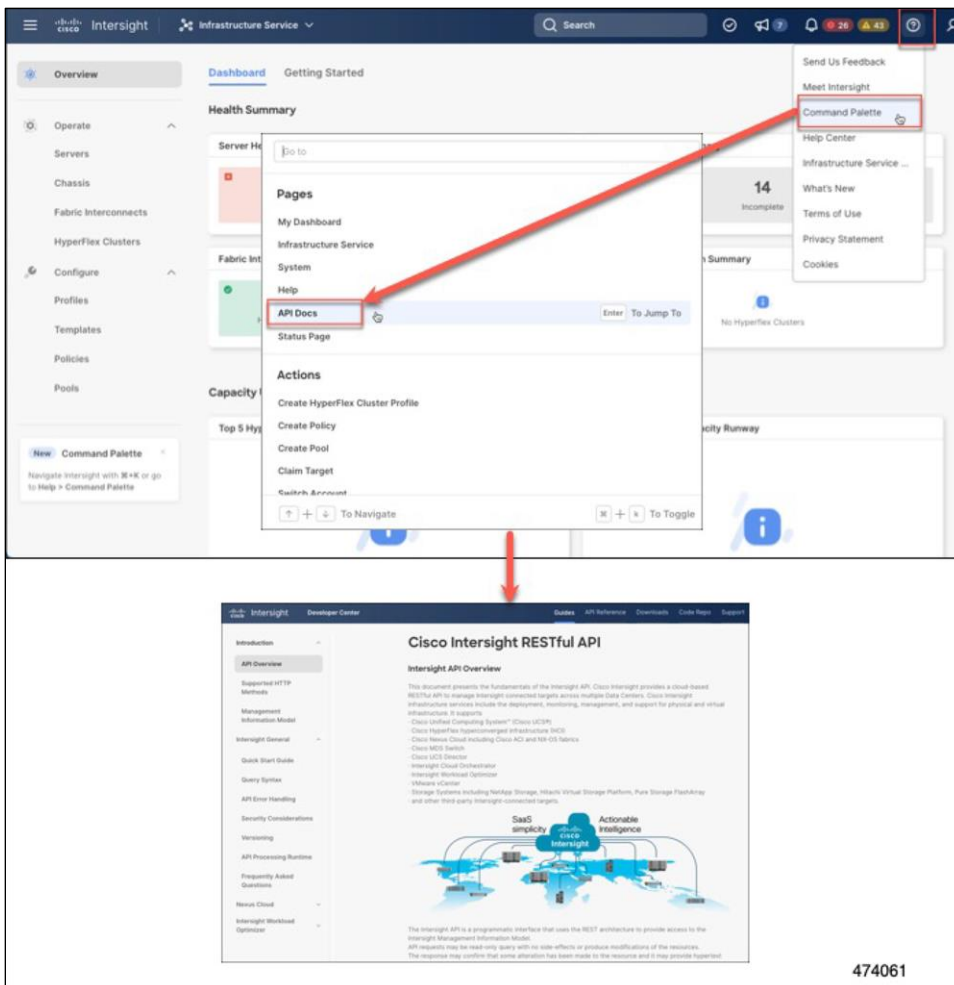

**Figure 35.**  
API documents



## Intersight rediscovery and decommissioning

Rediscovery and decommissioning of a chassis or server can be done in IMM-managed devices. Both operations are important to accurately capture new hardware or to remove a system from service for disposal or repurposing.

For a server, select the server link from the Infrastructure Services' left navigation menu, then select your device. Click the ellipses (...), then "System" in the drop-down menu. From here you can choose various options, including "Rediscover" and "Decommission."

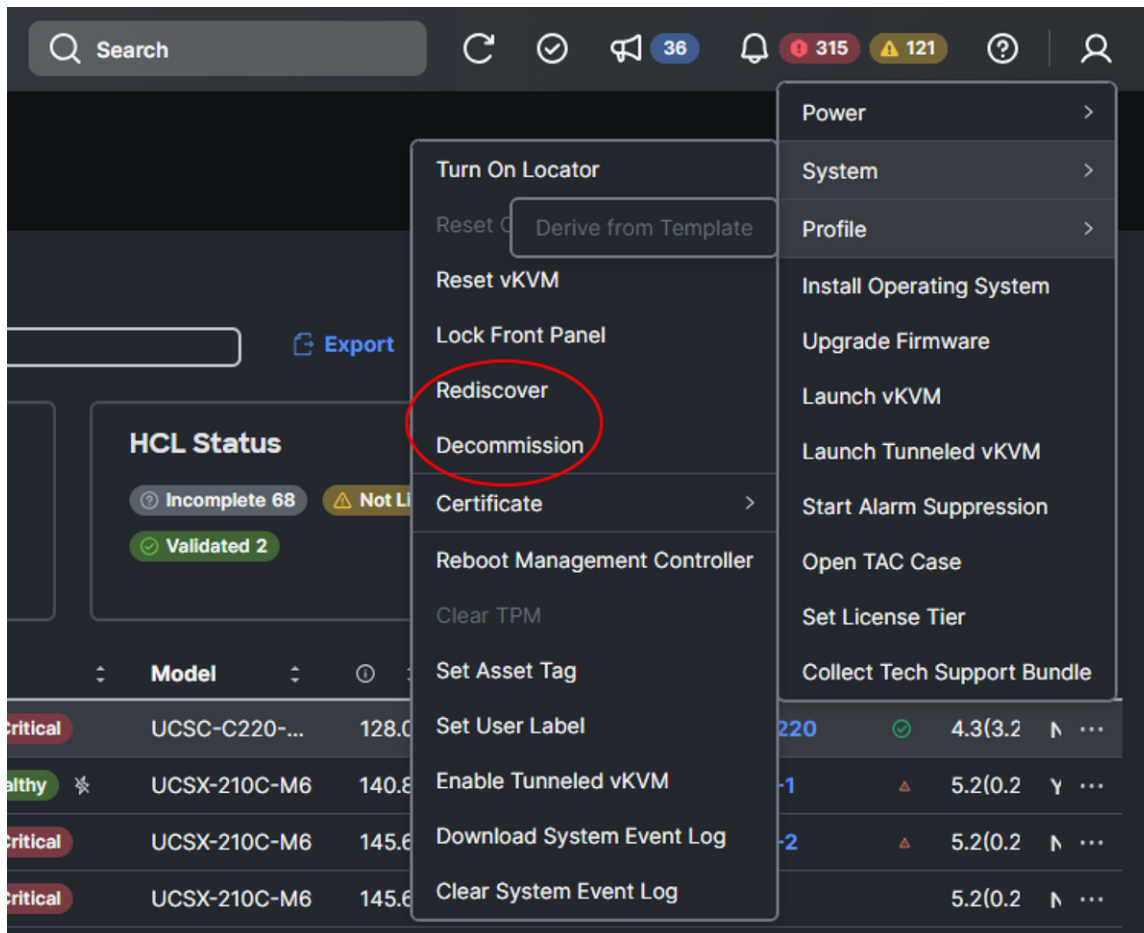

**Figure 36.**  
Rediscover or decommission a server

For a chassis, select the chassis link from the Infrastructure Services' left navigation menu, then select your device. Click the ellipses (...) in the drop-down menu. From here you can choose various options, including "Rediscover," "Decommission," and "Remove."

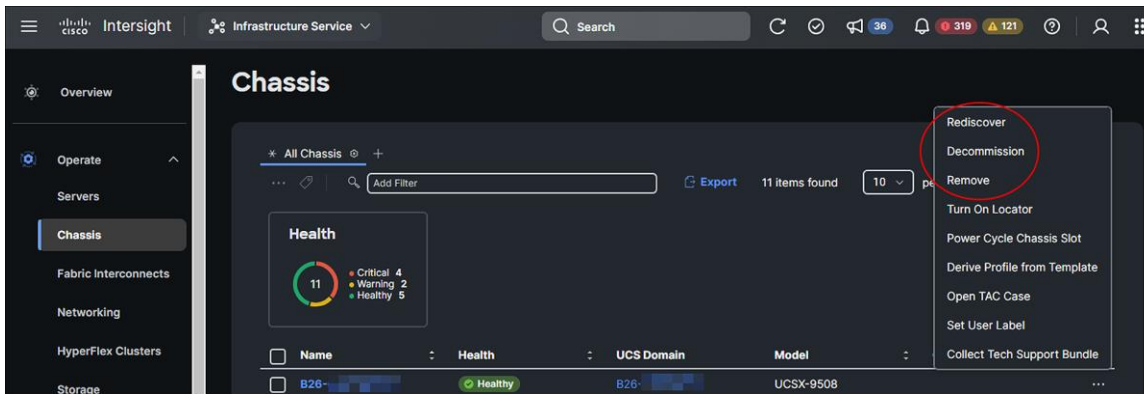

**Figure 37.**  
Rediscover, decommission, or remove a chassis

**Chassis:** rediscovery rebuilds the connection list between I/O cards and fabric interconnects. This action would trigger a workflow to update the connection information of both the I/O cards or intelligent fabric modules of the chassis and the fabric interconnects. If the connections have not changed, this operation will not impact service.

Rediscovery of a chassis can be executed from:

- Chassis list view ... -> Rediscover
- Chassis detailed view -> Actions -> Rediscover
- Fabric interconnect details -> Connections -> Chassis -> ... -> Rediscover

**Server:** rediscovery rebuilds the inventory of the server if any modules in the server were replaced, added, or removed. Rediscovery is also required to rebuild the server inventory if a server has been moved from another slot or chassis, or replaced. This action would trigger a workflow to retrieve the latest server inventory and location (chassis or slot, or rack-ID) and update the inventory. There would be an alarm indicating that a rediscovery needs to be performed.

Rediscovery does not normally impact service, especially if nothing in the server has been changed. We recommend, however, performing any of these actions in a maintenance window.

Rediscovery of a server can be executed from:

- Server list view ...> System > Rediscover
- Server detailed view > Actions > System > Rediscover
- Fabric Interconnect details > Connections > Servers > ... > System > Rediscover
- Chassis detailed view > Inventory > Servers > ... > System > Rediscover (This option is for blade servers only.)

---

Decommissioning removes a server or chassis and IOM inventories. A decommissioned chassis is likely to be eventually recommissioned. Part of the chassis information, including the chassis ID, is retained by Cisco Intersight. Decommissioning is performed when a server or chassis is physically present and connected, but you want to temporarily remove it from the Cisco Intersight configuration.

**Remove**—removes from Cisco Intersight the configuration of a chassis that has been physically removed. Before physically removing a chassis from the system, ensure that you unconfigure the server ports to which the chassis is connected. If you need to add a chassis that was earlier removed, back to the Cisco Intersight configuration, the chassis must be reconnected and then rediscovered. During rediscovery, Cisco Intersight will assign the chassis a new ID that may be different from ID that it was assigned earlier.

**Recommission**—brings the server or chassis and IOM back online and initiates the discovery process and then the inventory process. After this action is complete, you can access the server or chassis and any servers in it.

A list of decommissioned chassis is available in the “Devices” area under “Fabric Interconnects > **Fabric interconnect name** > Connections > Decommissioned.”

When you recommission the chassis, you have the option to configure the chassis ID.

## Securely decommissioning a system

**The discussion on system decommissioning here is distinct from the Intersight decommissioning discussed in the previous section.**

Securely decommissioning a server is a critical process to ensure that sensitive data is properly handled, and the server is retired in a way that minimizes the risk of data breaches or unauthorized access. Failing to decommission a server securely can lead to data exposure, legal and regulatory issues, and potential harm to an organization's reputation. Below are the levels of importance and the methods for securely decommissioning a server and its data.

Decommissioning a system or components of a system—specifically, the drives—requires special considerations in many circumstances. It is not sufficient to simply remove a drive or rotate a system out of production without sanitization. For older versions of UCS firmware, there are third-party applications that will run NIST-approved sanitization routines on plain-text drives or encrypted drives. The Commission Regulation (EU) 2019/424 requires that data be securely disposed of. Secure data disposal is accomplished by using commonly available tools that erase the data from the various drives, memory, and storage in Cisco UCS servers and reset them to factory settings. You must be familiar with what devices are present in your UCS server and run the appropriate tools for secure data deletion. In some cases, you may need to run multiple tools.

Beginning early 2024, UCS firmware supports disk and system sanitization. This can more appropriately be termed data sanitization. Cisco IMC supports this NIST 800-88-compliant data-sanitization feature. Using the data sanitization process, Cisco IMC erases all sensitive data, thus making extraction or recovery of user data impossible. As Cisco IMC progresses through the erase process, the status report is updated. You can check the status and progress of the data-sanitization process for each individual device erased from the report. Cisco IMC reboots when the data-sanitization process is completed and generates a report.

The erase process for data sanitization is performed in the following order on the server components:

1. Storage
2. VIC
3. BIOS
4. Cisco IMC

You can choose to either perform data sanitization on all the server components or select only storage and VIC components for data sanitization.

Proper decommissioning reduces the risk of data breaches. If data is not securely wiped, deleted, or destroyed, it may be accessible to unauthorized individuals who can exploit it for malicious purposes.

Secure decommissioning is essential for compliance with data-protection and privacy regulations. Many regulations, such as GDPR or HIPAA, require organizations to safeguard data even during disposal. It also serves to protect an organization’s intellectual property.

Additional procedural steps can be taken as well. These include physical destruction and environmentally responsible recycling of components where appropriate. If this is not possible because the systems will be reused, other things can be done such as disabling and removing all user accounts and resetting server configurations.

Secure decommissioning is a comprehensive process that involves technical, procedural, and organizational measures. By following these methods, organizations can minimize the risks associated with retiring servers and ensure that sensitive data is handled responsibly and securely.

## Unclaim

Unclaiming will remove a system from Intersight. This is part of a more comprehensive decommissioning process for disposal or repurposing of a system. Log into Intersight with the account administrator, device administrator, or device technician privileges. From the “Service Selector” drop-down list, select “System.” Navigate to Admin -> Targets.” Select the target to unclaim.

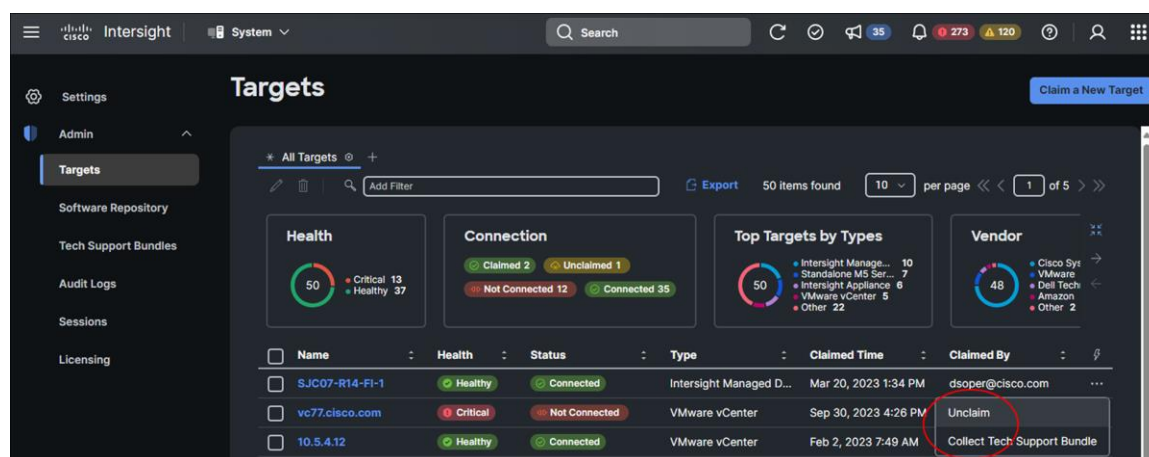

**Figure 38.**  
Unclaim a target

Once unclaimed, the target will no longer be available in Intersight. You can reclaim the device in the same way that you did originally if you wish to redeploy it.

## Secure application operation

### Confidential computing at the hardware level

Confidential computing is a cloud-computing technology that isolates sensitive data in a protected CPU enclave during processing. The contents of the enclave – the data being processed and the techniques that are used to process it – are accessible only to authorized programming code and are invisible and unknowable to anything or anyone else, including the cloud provider.

A confidential computing-secure enclave refers to a protected and isolated environment within a computing system where sensitive data or operations can be securely processed or stored. This secure enclave ensures that the data within it is protected from unauthorized access, even from other parts of the system or privileged software layers.

Cisco UCS implements all processor vendor confidential computing capabilities from AMD and Intel. This includes trusted execution environments through secure enclaves as well as the various flavors of memory encryption. Implementation of these features is processor-dependent and chosen at build or purchase time.

You enable these features in Intersight by setting BIOS policies.

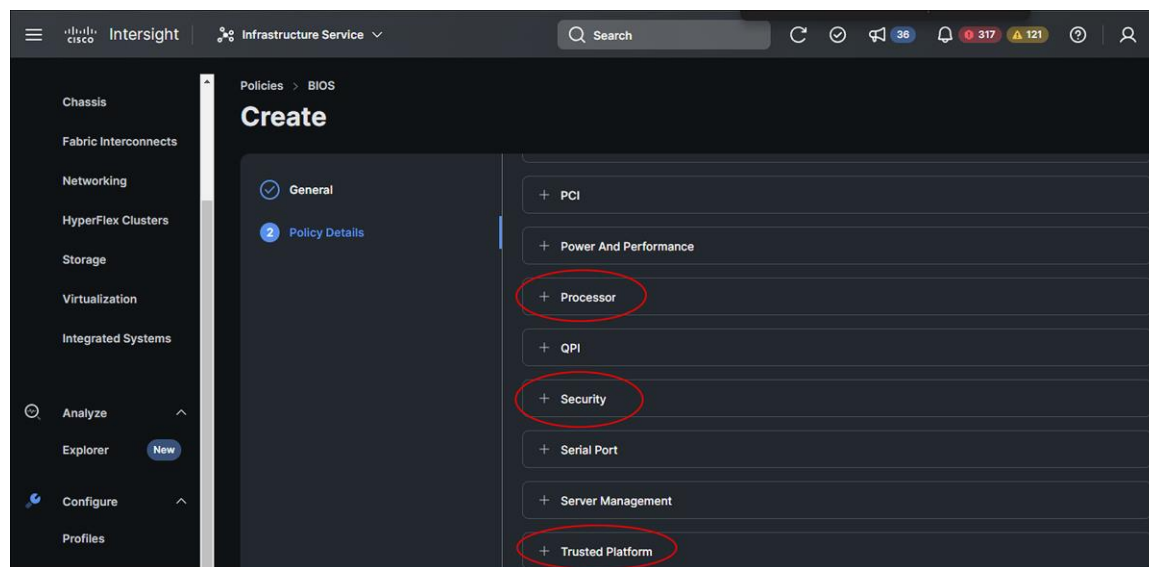

**Figure 39.**  
Create a BIOS policy

A complete list of BIOS tokens is available here:

[UCS BIOS Policy Management](#)

For additional details, please see the Cisco Compute Security Overview white paper:

[Cisco Compute Security Overview White Paper - Cisco](#)

---

## Secure data delivery and storage

### **Self-Encrypting Drives (SEDs) and drive-security policy**

Data-at-rest encryption on a Cisco UCS server can happen in software for VMs (for example, Vormetric Transparent Encryption or Vmcrypt) or by the operating system (for example, Microsoft's BitLocker). This can also be accomplished using hardware. To that end, Self-Encrypting Drives (SEDs) were developed and have many advantages. SEDs have a negligible impact on performance speed and latency. The encryption process is completely integrated into the drive, so there is no need for other system components to perform compute intensive encryption operations. SEDs are independent of the operating system, so even if a hacker attacks a computer, it is nearly impossible to access the SED (and the encryption keys stored within) when the computer is turned off.

In a Cisco UCS server, SEDs can utilize a remote key management solution. Remote key management is the recommended method for SED key management since it does not rely on stored or "remembered" pass phrases. The key-management software optimizes the SED's decryption and encryption functions and key management, relieving the user of any active SED administration. Lastly, SEDs are inexpensive to deploy and maintain. SEDs are encrypted the moment they come off the assembly line. Management software does the rest, ensuring that SEDs do their job without the need for human intervention.

Self-encrypting drives (SEDs) have special hardware that encrypts incoming data and decrypts outgoing data in real-time. The data on the disk is always encrypted in the disk and stored in the encrypted form. The encrypted data is always decrypted on the way out of the disk. A media encryption key controls this encryption and decryption. This key is never stored in the processor or memory. Both Cisco UCS Manager and Intersight support SED security policies on Cisco UCS C-Series servers, B-Series M5/6/7 servers, X-Series servers, and S-Series servers.

SEDs must be locked by providing a security key. The security key, which is also known as a key-encryption key or an authentication passphrase, is used to encrypt the media-encryption key. If the disk is not locked, no key is required to fetch the data.

The encryption and decryption for SEDs is done through the hardware. Thus, it does not affect overall system performance. SEDs reduce disk-retirement and -redployment costs through instantaneous cryptographic erasure. Cryptographic erasure is done by changing the media-encryption key. When the media-encryption key of a disk is changed, the data on the disk cannot be decrypted and is immediately rendered unusable. With Cisco UCS Manager Release 3.1(3), SEDs offer disk-theft protection for C-Series and S-Series servers.

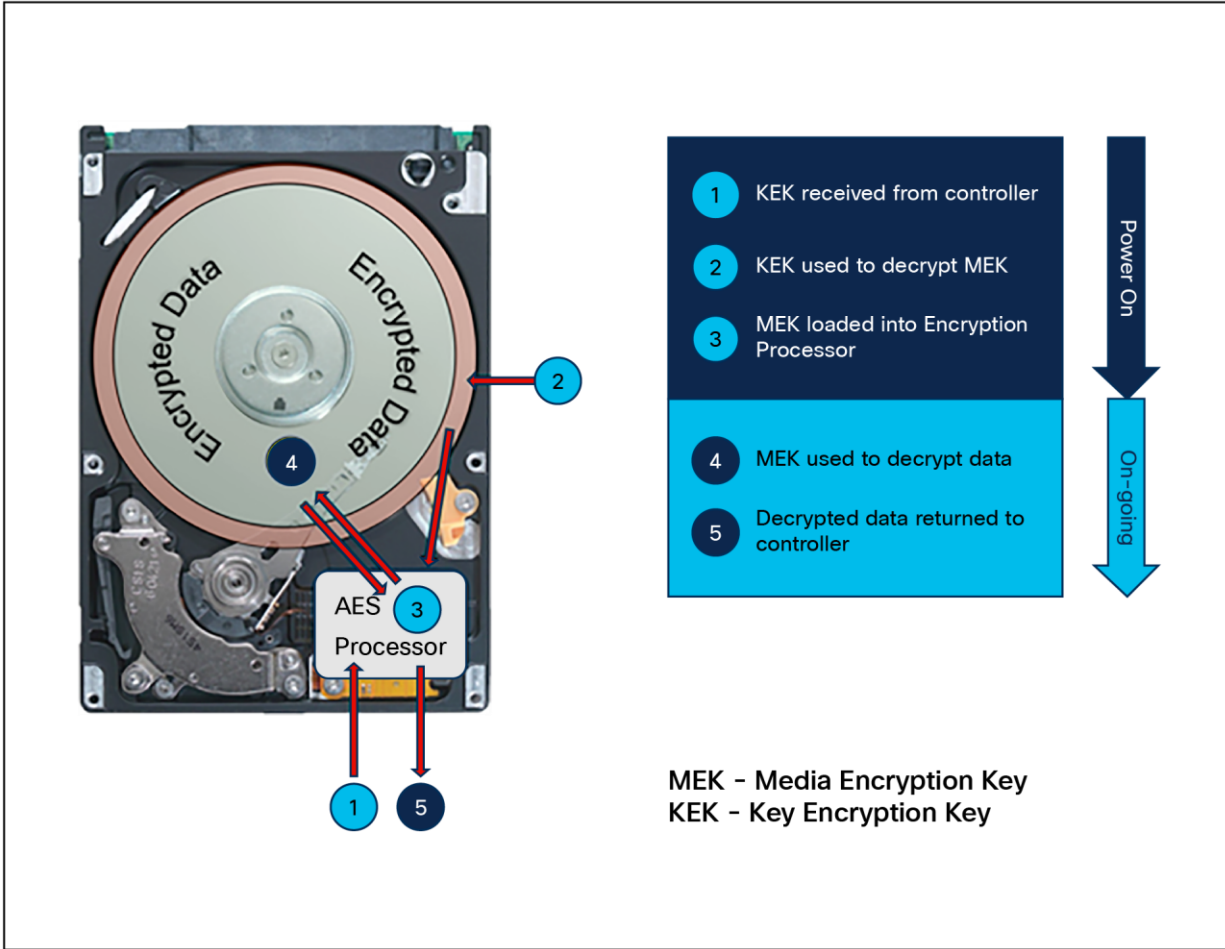

**Figure 40.**  
SED anatomy

Cisco Intersight enables you to configure remote security keys utilizing a third-party key Management server (KMS). The configuration for this is set in the drive security policy. You will need to create certificates and have the CA root certificate available to complete the process. We recommend that you work with your InfoSec team for this part of the deployment.

From the “Infrastructure Services” interface, select “Policies,” and then “Drive Security.”

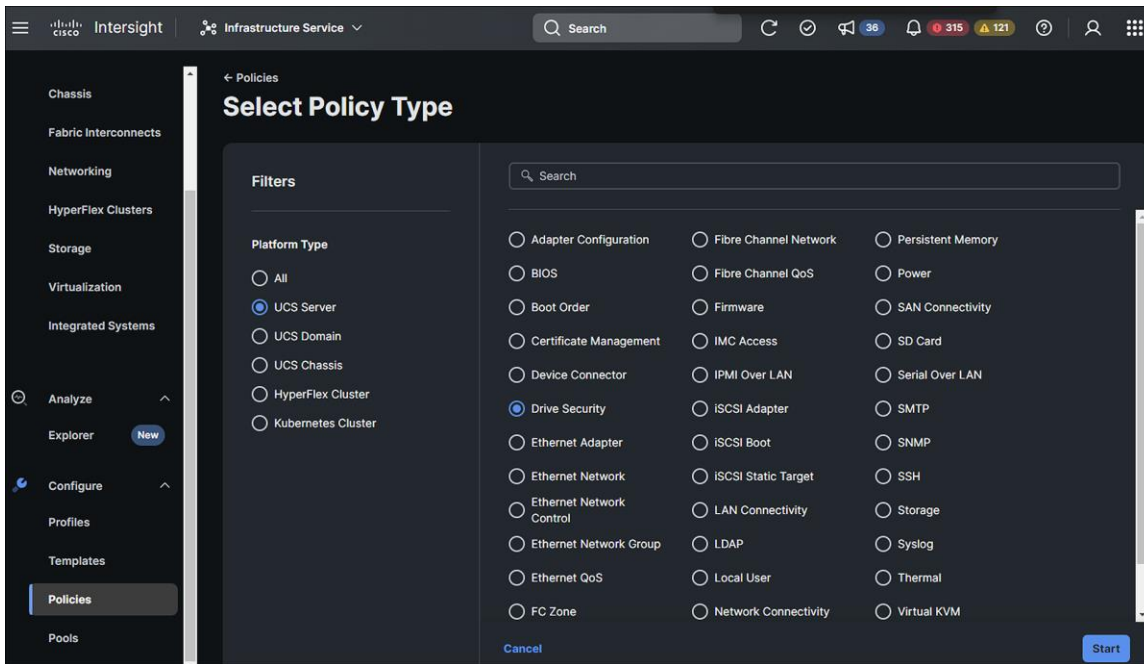

**Figure 41.**  
Drive-security policy

Click “Start.” Here you will enter your KMS information.

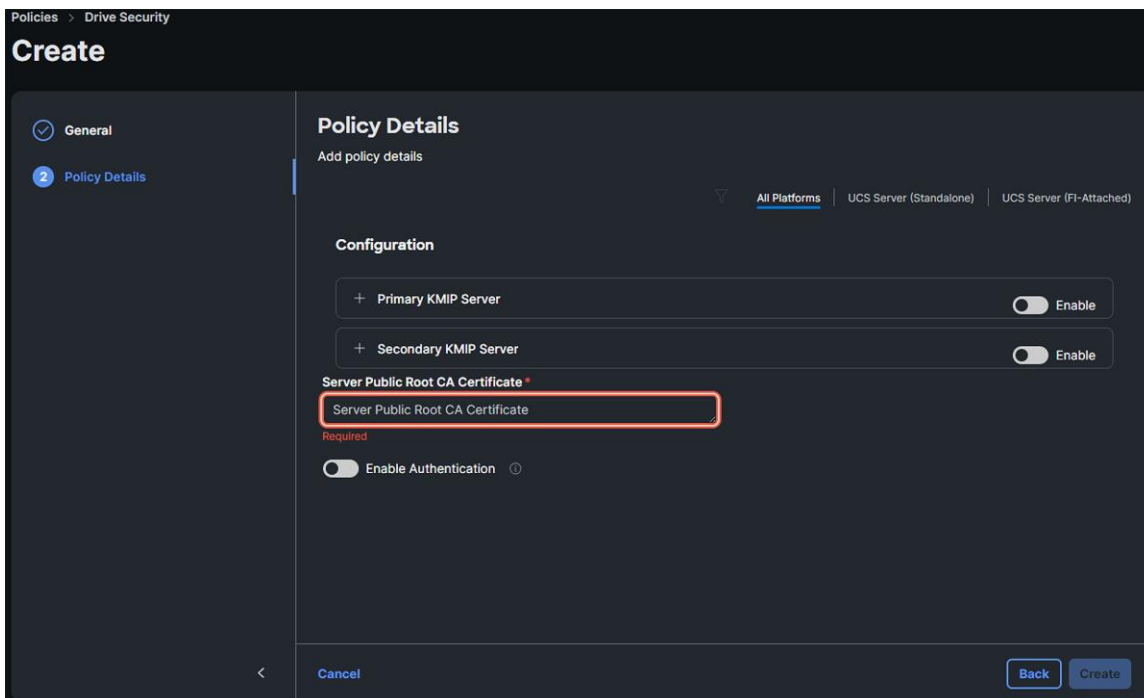

**Figure 42.**  
Enter KMS information

Click “Create” and complete the policy wizard.



## Encryption and key management

Certificate management for the system itself, distinct from the drive-security policy discussed above, is used for secure management of the target from the device connector and Intersight Assist. In Intersight Managed Mode, the certificate-management policy allows you to specify the certificate and private key-pair details for an external certificate and attach the policy to servers. You can upload and use the same external certificate and private key-pair for multiple Intersight Managed Servers.

From the “Infrastructure Services” interface, select “Policies,” and then “Certificate Management.” You will need to create certificates and have the CA root certificate available to complete the process. We recommend that you work with your InfoSec team for this part of the deployment.

Begin by selecting the certificate you want to update or replace.

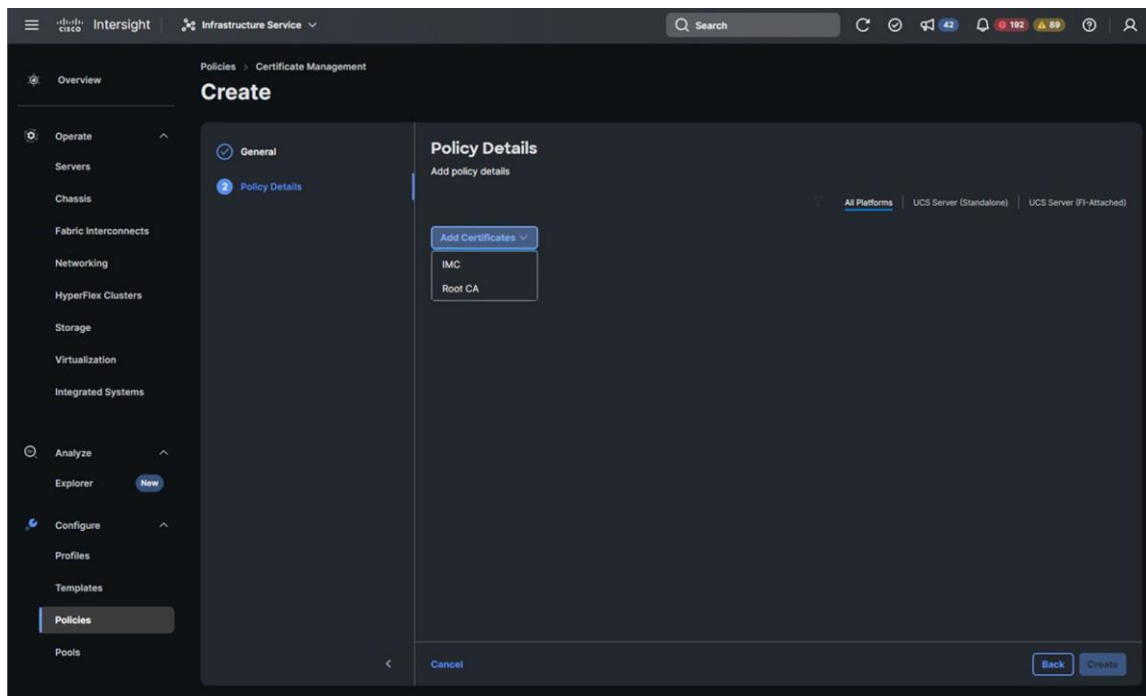

**Figure 43.**  
Select the certificate type to upload

Add the desired certificates.

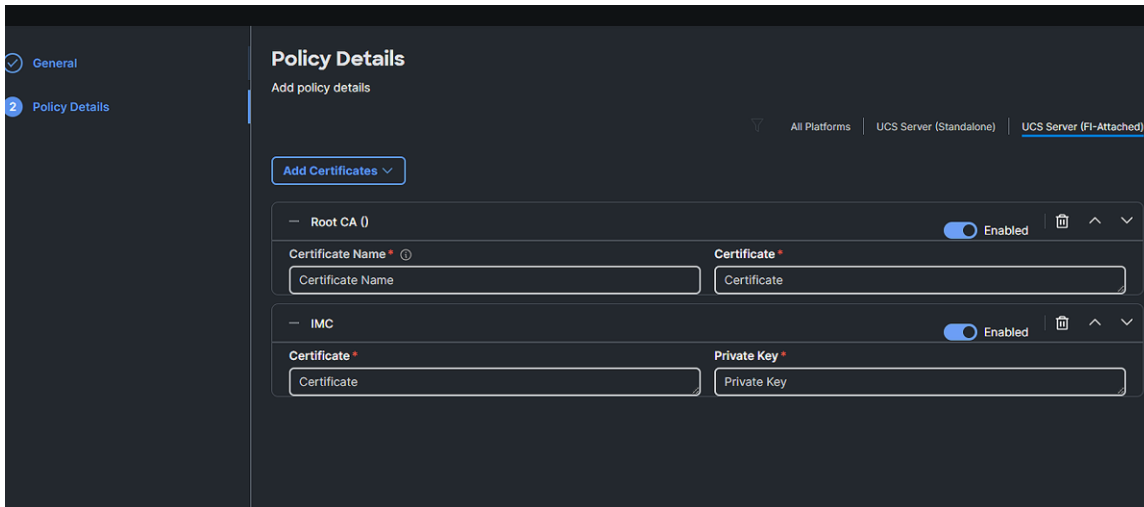
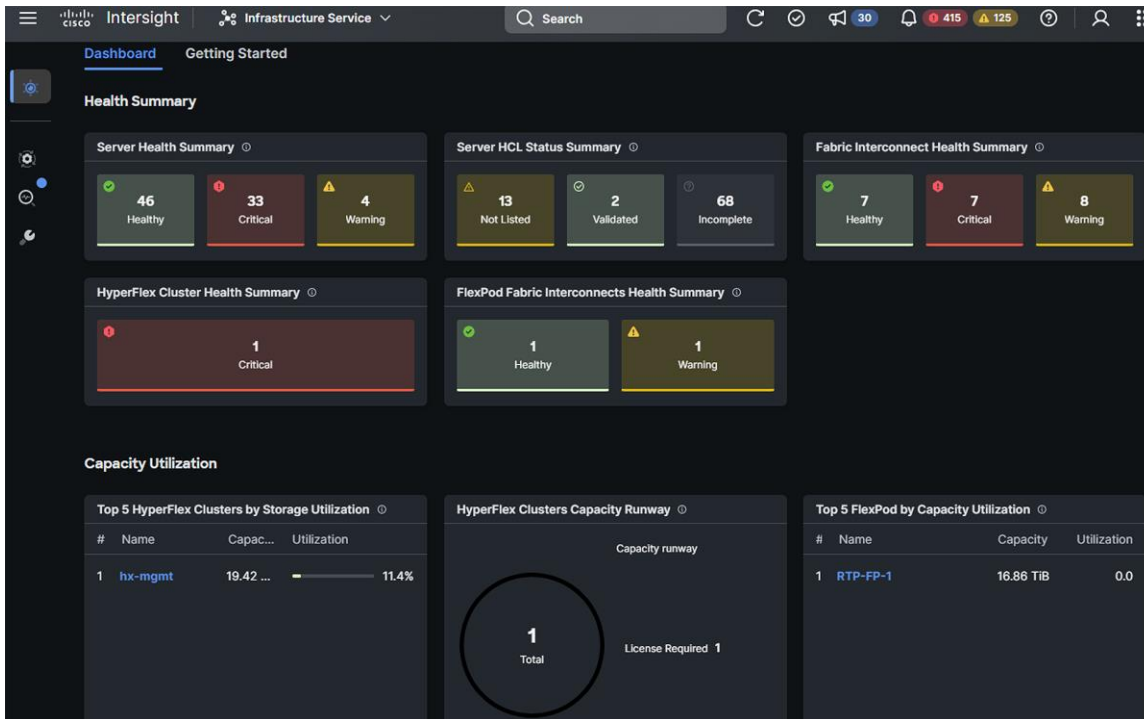

**Figure 44.**  
Upload the correct certificate and private key

## Monitoring with Intersight

Cisco Intersight provides a dashboard for real-time health and inventory status monitoring. You can create, customize, rename, and manage multiple dashboard views by adding, removing, or rearranging widgets. In the Widget Library, you can select the widget(s) that you want to pin to the dashboard, preview the details for a server or a cluster, search for a widget, and add a custom title to a widget. You can toggle between the detail and list view of the available widgets in the library. You can add multiple instances of a widget to monitor different targets. You can add a maximum of 30 widgets per dashboard.

Intersight monitoring services (IMS) provide historical and real-time visibility of resource consumption and inventory health, policies for notifications based on thresholds and anomaly detection, and actions and recommendations for automated infrastructure changes in response to events. IMS help reduce operational costs, prevent SLA violations, and increase system reliability and availability.



**Figure 45.**  
Intersight monitoring dashboard

Cisco Intersight Infrastructure Service (IIS)—built on the Cisco Intersight hybrid-cloud operations platform—is Cisco’s cloud-based infrastructure management solution delivered as a service. IIS is next-generation software that helps IT operations teams visualize, control, and automate compute, storage, and networking infrastructure—wherever it is—from one place.

- **Visualize** – Unlike traditional, siloed tools, Cisco Intersight gives you one consolidated dashboard to see your on-premises, cloud, and edge infrastructure—including their real-time status and interdependencies.
- **Control** – Whereas traditional infrastructure management typically requires multiple, repeated tasks, this platform lets you easily perform operations actions across your global infrastructure with just a few clicks so you stay in constant control. You can deploy, configure, and operate servers, VMs, storage, and networking throughout their lifecycle, from one place anytime, anywhere.
- **Prevent and resolve** – Improved capabilities to prevent and resolve issues stemming from computing hardware using advisories, hardware compatibility lists, proactive RMAs, firmware upgrades, and connected TAC are some of the biggest benefits operations teams get from Intersight.
- **Automate** – Instead of having to perform tasks manually, Intersight lets you automate day-0, day-1, and day-2 tasks and workflows to accelerate infrastructure operations.

Some of the key benefits of this platform include:

- **Speed:** deploy, configure, and maintain infrastructure in minutes—at scale—anytime, anywhere
- **Consistency:** ensure consistent server configuration across your global infrastructure to identify and eliminate configuration drift
- **Security:** apply strict security standards across infrastructure operations; continuously identify and mitigate potential security threats
- **Audits and compliance:** log all actions taken on your infrastructure; ensure consistent adherence to policies through automation, templates, and cross-domain management
- **Control and manage:** operate Cisco and third-party infrastructure from one place
- **Reduce or eliminate downtime:** address potential hardware, OS, and software issues before they impact users, or minimize them when they occur
- **Improve productivity:** reduce time spent on support, maintenance, and operation of multiple infrastructure domains, including networking, compute, storage, virtualization, and integrated systems

## Endpoint syslog

To set up syslog for your servers in Intersight, create a syslog policy. From the “Infrastructure Services” interface, select “Policies,” and then “Syslog.” Name the policy, then select “Next” to enter syslog details, including severity level and remote server information.

The screenshot displays the 'Edit Syslog Policy' configuration interface. The breadcrumb trail at the top reads 'Policies > Syslog > Syslog-test'. The main title is 'Edit'. On the left, there are two tabs: 'General' (selected) and 'Policy Details'. The configuration is divided into two sections: 'Local Logging' and 'Remote Logging'. Under 'Local Logging', there is a 'File' field and a 'Minimum Severity to Report' dropdown menu set to 'Warning'. Under 'Remote Logging', there is a 'Syslog Server 1' section with an 'Enable' toggle switch turned on. This section includes fields for 'Hostname/IP Address' (10.1.1.10), 'Port' (514), and 'Protocol' (TCP). Below these fields is another 'Minimum Severity To Report' dropdown menu set to 'Warning'. At the bottom of the 'Remote Logging' section, there is a 'Syslog Server 2' section with an 'Enable' toggle switch turned off. At the bottom of the page, there are 'Cancel', 'Back', and 'Save' buttons.

**Figure 46.**  
Syslog policy details

Select “Save” to complete the policy creation. Note that only the system event log (SEL) from the endpoint is covered in this policy. Transmission of endpoint SEL is not encrypted. For additional security, maintain the syslog server local to the endpoint, or enable an encrypted tunnel (IPsec, etc.) for the syslog server connection at your network border. For management audits, see the “Audit records, scope, and use cases” section below.

## Audit records, scope, and use cases

Intersight maintains persistent records of every action taken within Intersight. These records are kept in the audit logs. These records include the create, update, and delete operations for every policy, pool, profile, role, etc. Essentially every managed object is tracked here. You will be able to see every management event that has taken place with the account on the devices claimed by the account.

## Intersight Audit Records Entries

From the “System” interface, select “Audit Logs.” Alternatively, with Intersight’s command palette, press Ctrl+K (Windows/Linux) or Command+K (Mac) to pull up the search and type the word "audit," as shown in Figure 47. Note that you can only view the audit log if you have an account administrator or audit log viewer role.

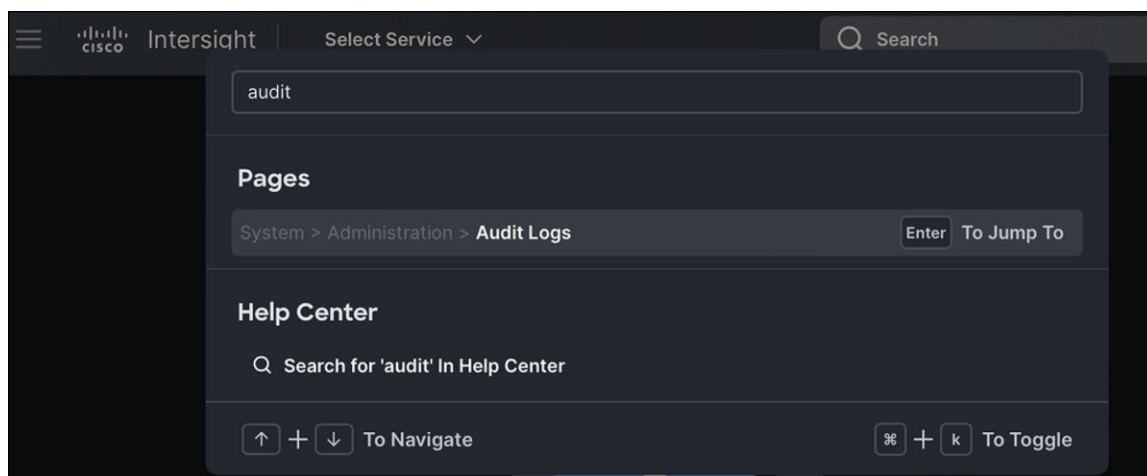

**Figure 47.**

Command palette for getting to audit records

Here you will see a list of all events across the account, including the user that initiated the action, when it occurred, what the action was, and what entity was affected.

The screenshot shows the Cisco Intersight interface with the 'Audit Logs' section selected. A table displays a list of audit log events. The table has columns for 'Affected Object', 'Event', 'User Email', 'Client Address', and 'Session ID'. The events include various system actions such as logins, logouts, modifications, and deletions performed by different users.

Object	Affected Object	Event	User Email	Client Address	Session ID
	sdegiorg@cisco.com	Login	sdegiorg@cisco.com	2001:420:c0c8:1003...	663bbb2875646133...
	mimaurer@cisco.com	Login	mimaurer@cisco.com	84.115.227.234	663bbb4d75646133...
	Syslog-test	Modified	akapacin@cisco.com	2001:420:c0c8:1003...	663badf975646133...
	Syslog-test	Created	akapacin@cisco.com	2001:420:c0c8:1003...	663badf975646133...
	movaswan@cisco.com	Login	movaswan@cisco.com	2001:420:28a:1254...	663bb9c875646133...
	jnew@cisco.com	Login	jnew@cisco.com	2001:420:c0c4:1004...	663bb96f75646133...
	jnew@cisco.com	Logout	jnew@cisco.com		663b9a9575646133...
	akapacin@cisco.com	Login	akapacin@cisco.com	2001:420:c0c8:1003...	663badf975646133...
	mfaiello@cisco.com	Login	mfaiello@cisco.com	173.38.117.85	663ba0575646133...
	System	Deleted	priframe@cisco.com	2001:420:282:1330...	663ba08175646133...
	May 8, 2024 9:11:56 ... Alarm Suppression	System	Created	priframe@cisco.com	2001:420:282:1330...
	May 8, 2024 9:03:00... User	System	Login	kkarupas@cisco.com	73.93.166.180

**Figure 48.**  
List of audit log events

You can drill down on the event by clicking the ellipses next to it. The figures below show a failed login attempt with the corresponding API JSON output followed by a successful login.

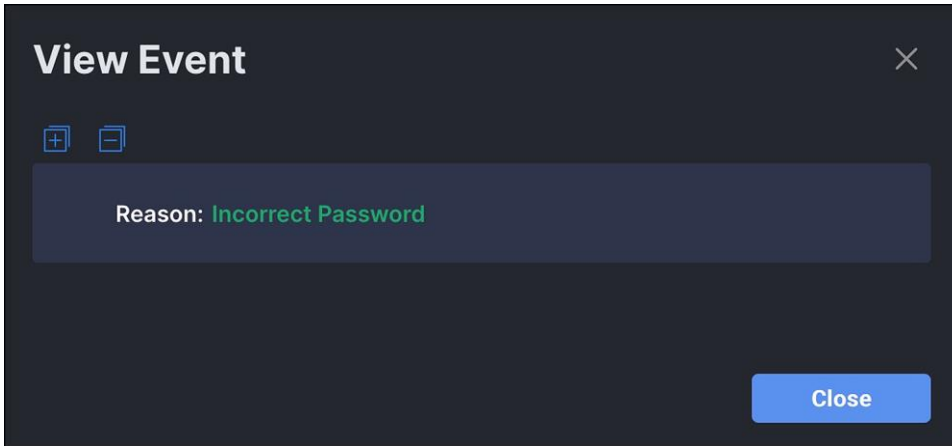

**Figure 49.**  
Failed login attempt

## Audit JSON from API on failed login attempt:

```
{
  "Account": {
    "ClassId": "mo.MoRef",
    "Moid": "627443cb7564612d30876271",
    "ObjectType": "iam.Account",
    "link": "https://sgaree-
pva.ucstme.cisco.com/api/v1/iam/Accounts/627443cb7564612d30876271"
  },
  "AccountMoid": "627443cb7564612d30876271",
  "AffectedObjectTypeLabel": "",
  "Ancestors": [],
  "ClassId": "aaa.AuditRecord",
  "CreateTime": "2023-11-14T17:00:30.61Z",
  "DomainGroupMoid": "627443cb7564612d30876272",
  "Email": "admin@local",
  "Event": "Failed Login",
  "InstId": "6553a791756461301ff4c2c4",
  "MoDisplayNames": {
    "Name": [
      "admin@local"
    ]
  },
  "MoType": "iam.User",
  "ModTime": "2023-11-14T17:00:30.724Z",
  "Moid": "6553a7ae697265301f37ca7b",
  "ObjectMoid": "62744b337564612d30879ddb",
  "ObjectType": "aaa.AuditRecord",
  "Owners": [
    "627443cb7564612d30876271"
  ],
  "PermissionResources": [],
  "Request": {
    "Reason": "Incorrect Password"
  },
  "SessionId": "",
  "Sessions": null,
  "SharedScope": "",
  "SourceIp": "",
  "Tags": [],
  "Timestamp": "2023-11-14T17:00:01.787Z",
  "TraceId": "NB7959e53b7f0bf7d557b568f6b910607b",
}
```

```

    "User": {
      "ClassId": "mo.MoRef",
      "Moid": "62744b337564612d30879ddb",
      "ObjectType": "iam.User",
      "link": "https://sgaree-
pva.ucstme.cisco.com/api/v1/iam/Users/62744b337564612d30879ddb"
    },
    "UserIdOrEmail": "admin@local"
  },

```

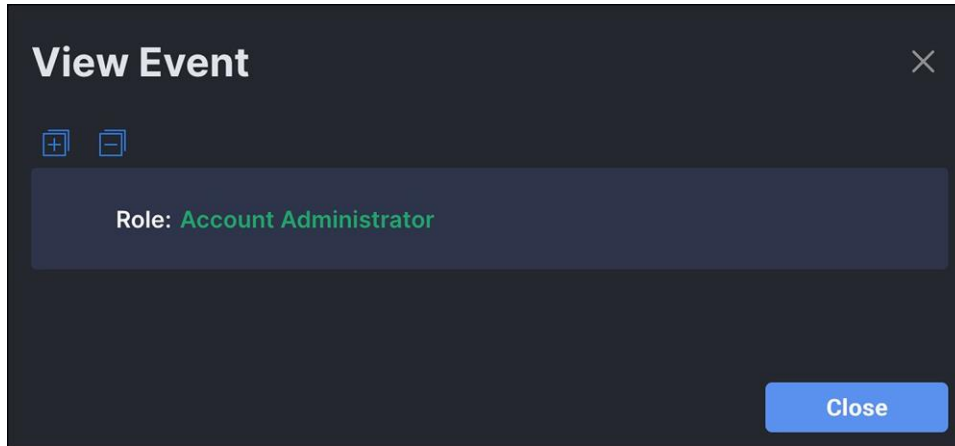

**Figure 50.**  
Successful administrator login

### Audit JSON on successful login

```

{
  "Account": {
    "ClassId": "mo.MoRef",
    "Moid": "627443cb7564612d30876271",
    "ObjectType": "iam.Account",
    "link": "https://sgaree-
pva.ucstme.cisco.com/api/v1/iam/Accounts/627443cb7564612d30876271"
  },
  "AccountMoid": "627443cb7564612d30876271",
  "AffectedObjectTypeLabel": "",
  "Ancestors": [],
  "ClassId": "aaa.AuditRecord",
  "CreateTime": "2023-11-14T17:00:30.619Z",
  "DomainGroupMoid": "627443cb7564612d30876272",
  "Email": "admin@local",
  "Event": "Login",
  "InstId": "6553a798756461301ff4c2c8",
  "MoDisplayNames": {
    "Name": [

```



```
    "admin@local"
  ]
},
"MoType": "iam.User",
"ModTime": "2023-11-14T17:00:30.724Z",
"Moid": "6553a7ae697265301f37ca81",
"ObjectMoid": "62744b337564612d30879ddb",
"ObjectType": "aaa.AuditRecord",
"Owners": [
  "627443cb7564612d30876271"
],
"PermissionResources": [],
"Request": {
  "Role": "Account Administrator"
},
"SessionId": "6553a798756461301ff4c2c7",
"Sessions": {
  "ClassId": "mo.MoRef",
  "Moid": "6553a798756461301ff4c2c7",
  "ObjectType": "iam.Session",
  "link": "https://sgaree-
pva.ucstme.cisco.com/api/v1/iam/Sessions/6553a798756461301ff4c2c7"
},
"SharedScope": "",
"SourceIp": "10.99.97.86",
"Tags": [],
"Timestamp": "2023-11-14T17:00:08.763Z",
"TraceId": "NBa8841f22dcf9933d0b69d8916b116696",
"User": {
  "ClassId": "mo.MoRef",
  "Moid": "62744b337564612d30879ddb",
  "ObjectType": "iam.User",
  "link": "https://sgaree-
pva.ucstme.cisco.com/api/v1/iam/Users/62744b337564612d30879ddb"
},
"UserIdOrEmail": "admin@local"
},
```

Despite the audit logs containing tens of thousands of pages of records, it is still easy to isolate events to a specific user with a simple filter. Directly above the table is a magnifying glass with the words "Add Filter." Clicking on the words "Add Filter" displays a drop-down list of attributes that can be used to filter the table. Multiple filters can be used.

The screenshot shows a web interface for "All Audit Logs". A search filter is applied: "User Email intuser-52a7d@cat-dcloud.com". The table displays 7 items. The columns are: Date/Time, Affected Object, Affected Object, Event, User Email, Client Address, and Session ID.

Date/Time	Affected Object	Affected Object	Event	User Email	Client Address	Session ID
Mar 31, 2023 5:30:16 ...	NTP	CTF-NTP-Policy-01	Modified	intuser-52a7d@cat-d...	173.38.220.49	6426b540756461330...
Mar 31, 2023 5:29:33 ...	User Preference	System	Modified	intuser-52a7d@cat-d...	173.38.220.49	6426b540756461330...
Mar 31, 2023 5:29:12 ...	User Preference	System	Modified	intuser-52a7d@cat-d...	173.38.220.49	6426b540756461330...
Mar 31, 2023 5:29:09 ...	User Preference	System	Modified	intuser-52a7d@cat-d...	173.38.220.49	6426b540756461330...
Mar 31, 2023 5:29:06 ...	User Preference	System	Modified	intuser-52a7d@cat-d...	173.38.220.49	6426b540756461330...
Mar 31, 2023 5:29:04 ...	User Preference	System	Modified	intuser-52a7d@cat-d...	173.38.220.49	6426b540756461330...
Mar 31, 2023 5:26:12 ...	User Preference	System	Modified	intuser-52a7d@cat-d...	173.38.220.49	6426b540756461330...

**Figure 51.**  
Audit entries

The table is sorted by most recent events, by default. You can drill down further by clicking the ellipses next to the event of interest.

The screenshot shows the same audit log interface as Figure 51, but with a "View Event" modal open for the first entry. The modal displays a tree view of event details:

- NtpServers: ( 1 )
  - 10.10.10.1
- Organization: ( 2 )
  - Moid: 632c78c76972652d30356cfb
  - ObjectType: organization.Organization

The modal also includes a "Close" button. The background table is partially visible, showing the same columns as in Figure 51.

**Figure 52.**  
Audit entry details

## Example use case: identify a record that has been changed

You can use the audit record to identify policy objects that have been modified. You can then use the API browser to perform a simple query for that managed-object ID (MOID). The API browser is a graphical tool for running API calls to Intersight without having to write any code. It is a tool for exploring and learning the API, but you can also use it for one-off API calls when you do not want to write any code.

To access the API browser:

1. Browse to [intersight.com/apidocs/apiref](https://intersight.com/apidocs/apiref)
2. Use the search box to look for "audit".
3. Click "aaa/AuditRecords".
4. Click the first GET method.

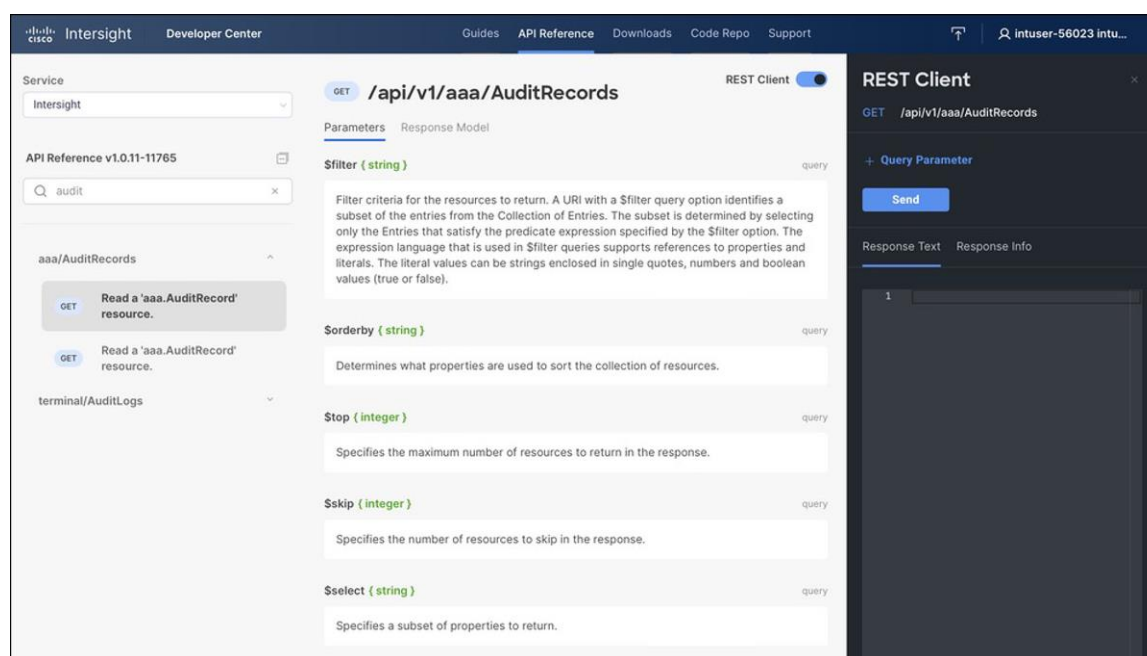

**Figure 53.**  
API browser

Apply a filter to reduce the number of records returned. The relevant query parameter called **\$filter**. To add a query parameter, click the blue **+ Query Parameter** above the **Send** button. The key is \$filter, and a sample MOID value is:

```
ObjectMoid eq '6425b04062757230016def13'
```

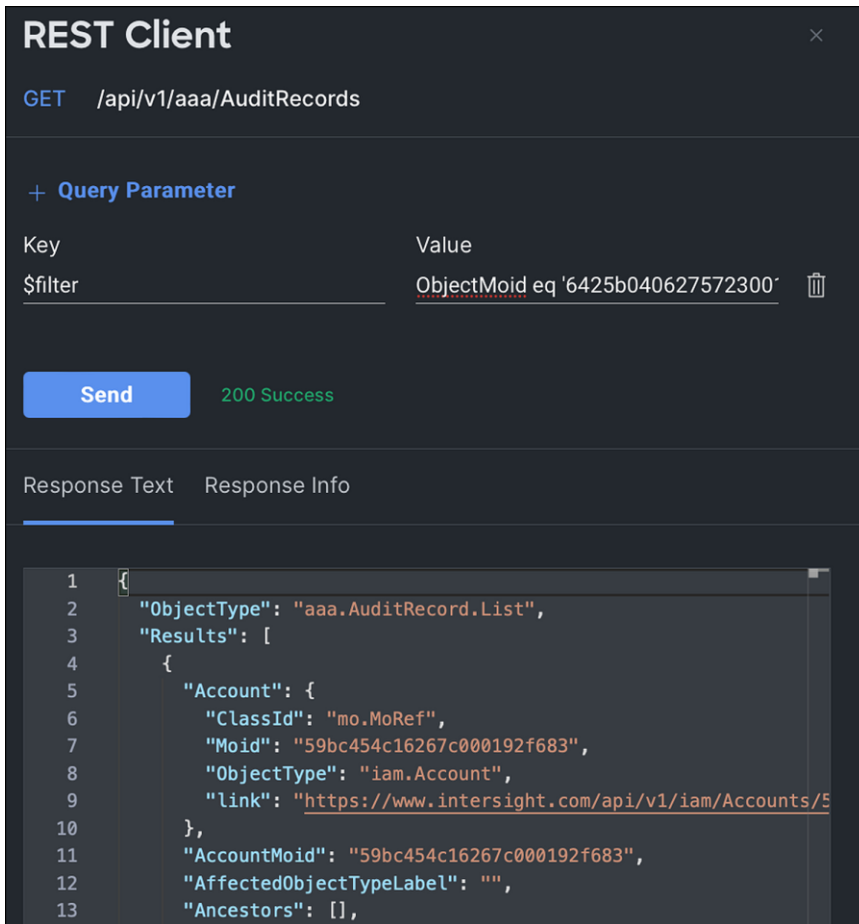

**Figure 54.**  
REST API query example using API explorer

Additional parameters can be added to the filter query to further reduce the results.

`$filter = ObjectMoid eq '6425b04062757230016def13' and Event eq Created`

### Intersight Virtual Appliance monitoring

The Intersight Virtual Appliance provides an overview of the appliance and health status and displays alarms when predefined limits are exceeded or when a threshold is raised.

In the appliance UI, from the “Service Selector” drop-down list, choose “System,” and navigate to “Settings > GENERAL > Appliance” to view the following details under “Appliance”:

- **Health**—the overall status of the appliance
- **Hostname**—your FQDN or hostname
- **Version**—the installed version of the appliance software
- **Deployment size**—the appliance deployment size. For detailed information about the deployment size, see [Supported Configuration Limits for Intersight Virtual Appliance](#)
- **Node**—a table view of the list of appliance nodes in the Cisco Intersight Virtual Appliance. You can search for a specific node by the IP address, operational status, gateway, or netmask. You can view the alarms in the right pane and filter them by their severity.

The Intersight Virtual Appliance monitors certain critical parameters and raises alarms when predefined limits are exceeded or when a threshold is raised. The appliance currently reports system-level and node-level alarms. The following table shows the alarm levels and their descriptions:

**Table 5.** Alarm levels for Intersight Appliance logging

Level	Component	Description	Comments
System	Node	A node is down.	One alarm per node
System	Node	A node is not ready for service deployment.	One alarm per node
Node	CPU usage	CPU usage above threshold	One alarm per node. Threshold: 75%
Node	Memory usage	Memory usage above threshold	One alarm per node. Threshold: 75%
Node	File system disk usage	File system disk usage above threshold	One alarm per file system. Threshold: 75%
System	Number of service instances running	Number of service instances running less than expected	One alarm for any service down
System	Number of service instances ready	Number of service instances ready less than expected	One alarm for any service down
System	Web certificate	Warning: web certificate will expire within 120 days. Critical: web certificate will expire within 90 days.	One alarm per appliance
System	Device certificate	Warning: device certificate will expire within 120 days. Critical: device certificate will expire within 90 days.	One alarm per appliance
System	Appliance backup	Warning: an Intersight appliance backup has not been created within the past week. Please schedule or create a new backup.	One alarm per appliance
System	Appliance backup	Critical: the most recent Intersight Appliance backup failed. Please schedule or create another backup.	One alarm per appliance

Level	Component	Description	Comments
System	Cloud connectivity	Warning: connection to Intersight cloud has been down for more than 30 days.  Critical: connection to Intersight cloud has been down for more than 60 days.  Highly critical: connection to Intersight cloud has been down for more than 90 days; claiming new devices is not permitted until connection is restored.	One alarm per appliance
Node	Network link connectivity	Warning: the latency between cluster nodes is greater than 10ms.	One alarm per link per node

**Note:** Cisco UCS C-Series server-related faults such as power-supply and fan failures are not forwarded by Intersight Virtual Appliance to an external syslog server. Please configure the external syslog server on the UCS C-Series CIMC side to handle the forwarding of the UCS C-Series events and faults.

### Intersight and PVA/CVA syslog settings

Intersight Virtual Appliances offer external syslog configuration from System Settings. This syslog is for external retention of appliance logs, not for end-point logs. You can designate the web server access logs, audit logs, and alarms to be included in the log transport.

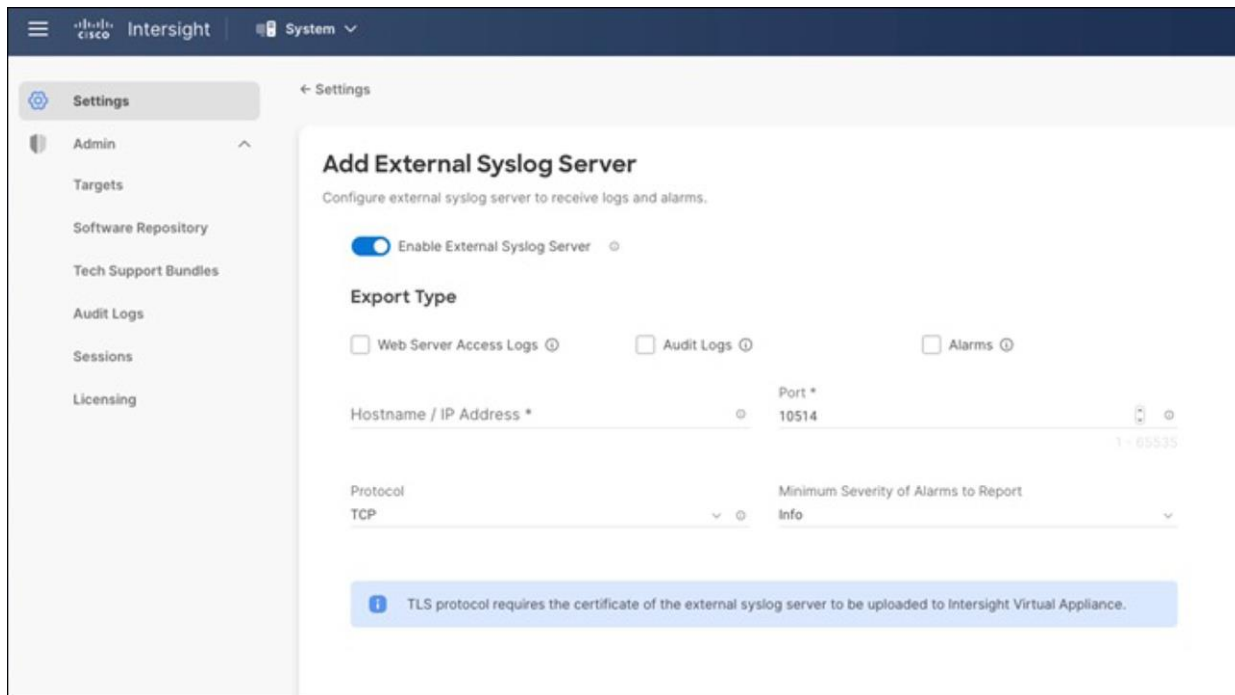

**Figure 55.**  
External syslog policy for Intersight Virtual Appliance

---

## Conclusions

This guide has provided information and best practices for implementing Cisco UCS server ecosystems with Intersight. It is applicable to both on-premises implementations using the Private Virtual Appliance, the hybrid Connected Virtual Appliance, and the Cisco SaaS Intersight cloud service.

We looked at the chain of trust and how it relates to secure supply chain and manufacturing. This was followed by a comprehensive overview of certification and compliance on the Intersight platform. We looked at system and service privacy, communication, and connection methods. This was followed by the system-level security features of Cisco UCS in an Intersight deployment, which include secure system boot as well as policy-based deployments at scale. We covered monitoring, audit logs, decommissioning, and secure storage.

When we combine the inherent security features of the Cisco UCS platform, managed by Intersight, with common-sense security practices such as the following:

- Maintenance of physical security
- Keeping server OS and firmware patched and updated to mitigate new threats
- Disabling functions that are not required
- Maintaining application security with RBAC, patching, and firewalls, and
- Storing and delivering data securely with encryption in hardware both on the server and on the wire through ecosystem design.

we can ensure that our server environments are as secure as possible.

## For more information

**Note:** Some of these links will require a Cisco account to log in.

### **Intersight general security information**

[Cisco Trust Portal](#)

[Cisco Security](#)

[Cisco Security Advisories](#)

[Cisco Trustworthy Technologies](#)

### **Additional Intersight certification information**

[Star Registry Listing](#)

[FIPS 140-2 Compliance](#)

[ISO/IEC 27001:2013 certificate](#)

[ISO/IEC 27017:2015 certificate](#)

[Cisco Intersight SOC 3](#)

### **Additional Intersight security guides**

[Cisco Intersight Platform Privacy Data Map](#)

[Cisco Intersight Platform Security Brief](#)

---

## Appendix A – Common security FAQ

### **How can I directly navigate to my identity provider for authentication?**

You can bypass the Intersight main page during login by using a link containing the Intersight account and SSO ID, which will take you directly to your identity provider for authentication. The link should be structured to include the account ID, as well as the user ID being authenticated. An example of the link:

<https://5eb2e1e47564612d3079fe92.intersight.com/iam/weblogin?email=abc@domain.com>.

### **How do I claim multiple targets at once in Intersight? Can I automate the bulk target claim process?**

You can automate a bulk target claim using the Cisco Intersight API and Python SDK. For more information, see [Automated Intersight Device Claim](#).

### **What happens to my data after I delete my account?**

After account deletion, data is retained for a period of 90 days. You can place a request to purge the data upon termination of service. See the “Data deletion and retention” section in the [Intersight Privacy Data Sheet](#).

### **Does Intersight use HTML5 on all pages? Does Intersight require any additional plug-ins?**

Yes, Intersight uses HTML5 on all pages. Intersight does not require any additional plug-ins beyond your browser's capabilities.

### **Does my application traffic flow into Intersight?**

All application data and traffic remain on premises and control data (configuration, provisioning, and monitoring) is transmitted to Intersight.

### **Does Cisco have access to data running in my private cloud?**

No, Cisco Intersight connects to the platform management interface, and the host/application data is not shared or accessed by Cisco Intersight.

### **Does Cisco Intersight support single sign-on (SSO) to integrate with my company's directory services?**

Yes, Intersight supports SSO through SAML 2.0 to enable you to integrate with your company's directory services.

### **How often is the Intersight customer data backed up?**

Customer data is encrypted using industry-standard AES-256 algorithm and backed up daily using automated scripts. Backups are replicated to a second region. Intersight retains the last 30 daily backups.

### **What is a resource group in Intersight?**

A resource group is a logical container of resources available for a user account. An Intersight user classifies and manages resources through resource groups. The user can assign a resource group to one or multiple organizations.

### **What is an organization in Intersight?**

An organization is a logical entity that supports multitenancy within an account through grouping of resources. An Intersight user can map the resource group to specific organizations and configure profiles and policies within the organization that can be applied to the targets.

### **What is a role? What is a system-defined role?**

A role represents a collection of privileges to perform a set of operations and provides a user access to resources. A system-defined role is created by default in an account. Each system-defined role has a unique



---

privilege, such as a device-administrator or service-administrator privilege, associated with it. These roles cannot be edited by users, and they apply to an entire account. The system-defined roles in Intersight are account administrator, read-only, HyperFlex cluster administrator, server administrator, user access administrator, device administrator, and device technician.

### **What is a user-defined role? Why do I need a user-defined role?**

User-defined roles are introduced to grant multiple privileges to a role, and to expand the scope of a privilege to an entire account or to an organization. For example, “Role-All” could include a combination of server-administrator and device-administrator privileges applicable account-wide. “Role-Org - 'Org1'” could include a combination of server-administrator and read-only privileges, and “Role-Org - 'Org2'” could include a combination of HyperFlex cluster-administrator and server-administrator privileges, applicable organization-wide.

### **What is a privilege?**

A privilege is a set of actions grouped by functionality, such as server administrator, read-only, device technician, etc. A role can have a unique or multiple privileges associated with it.

### **What is single sign-on?**

Single sign-on (SSO) authentication enables you to use a single set of credentials to log into multiple applications. With SSO, you can sign into Cisco Intersight with your corporate credentials instead of your Cisco ID.

### **How does Intersight enable SSO?**

Cisco Intersight supports SSO through SAML 2.0 and acts as a service provider (SP) to enable integration with IdPs for SSO authentication. You can configure your account to use the Cisco ID and SSO to sign into Intersight. To integrate your IdP with Intersight, you must have an Intersight account. If you do not have an Intersight account, you can set up one on [intersight.com](https://intersight.com).

### **Why am I seeing two different options to log into Intersight?**

Intersight now provides two options to sign in. Select Cisco ID, or your corporate ID that you have registered with your IdP if you want to sign in with SSO. You can sign into your account from <https://intersight.com/> or log in directly with your account URL, which is [https://account\\_id.intersight.com](https://account_id.intersight.com).

### **What is multifactor authentication?**

Multifactor authentication is the process of using a factor to identify users in addition to the password or another known factor. Multifactor authentication provides an extra layer of security to protect your account and reduces the risk of unauthorized access to your sensitive data.

---

### **When will I be required to set up multifactor authentication?**

You will be required to set it up for your new or existing Intersight account after you enable the requirement for multifactor authentication in Intersight.

### **Is the verification code mandatory?**

Yes, the verification code is mandatory when you enable multifactor authentication, regardless of where you enable it – from Intersight or from the Cisco ID profile management portal.

### **How can I generate a verification code?**

You can install a desktop/mobile app or choose to get the verification code sent to your email. Follow the instructions provided in the Cisco ID profile management portal to complete the setup of the authentication application before you generate the verification code.

### **How is the device connector upgraded?**

Device connectors are upgraded automatically without any impact on other software components. They are upgraded in the following cases:

- When a supported system (Cisco UCS Manager, Cisco HyperFlex) is upgraded, except when the device connector is already at a recent version
- When security patches are required
- When a new functionality introduced in Intersight requires a device connector upgrade

### **What information does the device connector collect?**

Device connectors collect the following information:

- Inventory data for all components including storage controllers, network adapters, IO modules, fabric interconnects, and CPUs for Cisco UCS and HyperFlex Systems
- Inventory, and server operational data, such as faults to provide automated recommendations
- Tech-support files when requested by Cisco Technical Assistance Center (Cisco TAC)

**Note:** Device connectors do not collect sensitive data such as passwords configured in the supported systems.

### **Who has access to information collected by Intersight?**

The Cisco Intersight-supported team, a limited group of Cisco engineers and support staff, have access to information collected by Intersight. See the “Access control” section in the [Intersight Privacy Data Sheet](#).

## Appendix B – PVA/CVA licensing data details

What does the licensing string required for the PVA installation contain? Is it a completely random string, or does it contain obscured information? The figure below shows a sample of this license.

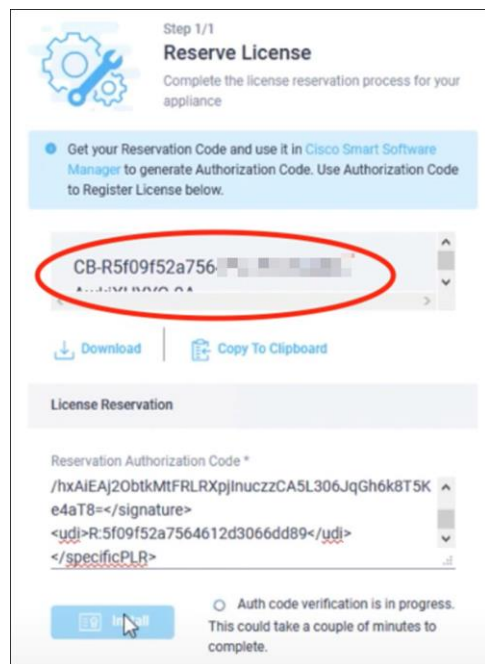

**Figure 56.**  
PVA license codes

This is a base58 encoding (chosen over base64 to eliminate some problematic characters for human transcription, such as zero and capital "O") for the UDI. These licenses are securely transmitted using AES256 and contain the following:

Code content: <version><sequence>-<UDI>-<SW id tag>-<hash>

The hash in this case is the last two characters of the MD5 of the IDs. The UDI is a new device identifier generated during the process that consists of the PID, serial number, and UUID.

The information that is used to generate the reservation code is the account ID, which is the product ID for licensing.

---

The request code contains:

- UDI of the device
- Software ID of the device

The software ID is displayed on “show license tech support” and is common for all instances of the same version. The UDI is unique to your instance. But having a UDI itself will not be able to provide any access. The UDI information is also common information that is sent to and received by Cisco.

Other than this, there is no information related to the customer or customer account in the request code.

The reservation workflow is not communicated over the internet. You need to log into your appliance and paste the request code to select what type of license to reserve.

**Americas Headquarters**  
Cisco Systems, Inc.  
San Jose, CA

**Asia Pacific Headquarters**  
Cisco Systems (USA) Pte. Ltd.  
Singapore

**Europe Headquarters**  
Cisco Systems International BV Amsterdam,  
The Netherlands

Cisco has more than 200 offices worldwide. Addresses, phone numbers, and fax numbers are listed on the Cisco Website at <https://www.cisco.com/go/offices>.

Cisco and the Cisco logo are trademarks or registered trademarks of Cisco and/or its affiliates in the U.S. and other countries. To view a list of Cisco trademarks, go to this URL: <https://www.cisco.com/go/trademarks>. Third-party trademarks mentioned are the property of their respective owners. The use of the word partner does not imply a partnership relationship between Cisco and any other company. (1110R)