



Prisma II High Power Optical Amplifier

Installation and Operation Guide







For Your Safety

Explanation of Warning and Caution Icons



Avoid personal injury and product damage! Do not proceed beyond any symbol until you fully understand the indicated conditions.

The following warning and caution icons alert you to important information about the safe operation of this product:

-  **You may find this symbol in the document that accompanies this product. This symbol indicates important operating or maintenance instructions.**
-  **You may find this symbol affixed to the product. This symbol indicates a live terminal where a dangerous voltage may be present; the tip of the flash points to the terminal device.**
-  **You may find this symbol affixed to the product. This symbol indicates a protective ground terminal.**
-  **You may find this symbol affixed to the product. This symbol indicates a chassis terminal (normally used for equipotential bonding).**
-  **You may find this symbol affixed to the product. This symbol warns of a potentially hot surface.**
-  **You may find this symbol affixed to the product and in this document. This symbol indicates an infrared laser that transmits intensity-modulated light and emits invisible laser radiation or an LED that transmits intensity-modulated light.**

Important

Please read this entire guide. If this guide provides installation or operation instructions, give particular attention to all safety statements included in this guide.

Notices

Trademark Acknowledgments

Cisco and the Cisco logo are trademarks or registered trademarks of Cisco and/or its affiliates in the U.S. and other countries. A listing of Cisco's trademarks can be found at www.cisco.com/go/trademarks.

Third party trademarks mentioned are the property of their respective owners.

The use of the word partner does not imply a partnership relationship between Cisco and any other company. (1110R)

Publication Disclaimer

Cisco Systems, Inc. assumes no responsibility for errors or omissions that may appear in this publication. We reserve the right to change this publication at any time without notice. This document is not to be construed as conferring by implication, estoppel, or otherwise any license or right under any copyright or patent, whether or not the use of any information in this document employs an invention claimed in any existing or later issued patent.

Copyright

© 2008, 2013 Cisco and/or its affiliates. All rights reserved. Printed in the United States of America.

Information in this publication is subject to change without notice. No part of this publication may be reproduced or transmitted in any form, by photocopy, microfilm, xerography, or any other means, or incorporated into any information retrieval system, electronic or mechanical, for any purpose, without the express permission of Cisco Systems, Inc.

Contents

Important Safety Instructions	vi
Laser Safety	xiv
Chapter 1	Introduction..... 1-1
Overview	1-1
Description.....	1-3
The Front Panel	1-5
The Back Panel	1-6
Configuration Overview	1-7
Chapter 2	Installation..... 2-1
Overview	2-1
Preparing for Installation.....	2-2
Site Requirements	2-3
Installing the Module in the Chassis	2-6
Connecting Optical Cables	2-8
Connecting the ICIM to Additional Chassis	2-12
Connecting the Chassis to the TNCS Server	2-13
External Alarms Connections.....	2-15
Chapter 3	Operation Using the ICIM..... 3-1
Overview	3-1
ICIM Introduction.....	3-2
The ICIM Front Panel	3-3
The ICIM Password	3-6
Operating the ICIM.....	3-13
Monitoring Operating Status Using the ICIM	3-17
Configuring the Optical Amplifier Using the ICIM.....	3-19
Checking Optical Amplifier Alarms Using the ICIM	3-21
Checking Manufacturing Data Using the ICIM	3-25
Using the ICIM to Save the Configuration.....	3-27
SNMP Configuration Capability	3-28
Community Names	3-32

Contents, Continued

	Setting SNMP Trap Receiver Parameters	3-33
	New SNMP Variables.....	3-34
	Boot Dialog for ICIM/SNMP Configuration	3-36
	New Procedure for Adjusting Alarm Thresholds	3-41
Chapter 4	Operation Using LCI.....	4-1
	Overview	4-1
	LCI Introduction	4-2
	System Requirements	4-3
	Installing LCI.....	4-4
	Connecting Your Computer to the Chassis.....	4-7
	Starting LCI.....	4-8
	LCI Module Tree Overview.....	4-10
	Accessing the Module Details Window.....	4-12
	Checking the Operating Status	4-19
	Configuring the Optical Amplifier	4-21
	Checking Optical Amplifier Alarms	4-23
	Modifying Optical Amplifier Alarm Limits.....	4-25
	Checking Manufacturing Data.....	4-27
Chapter 5	Maintenance and Troubleshooting	5-1
	Overview	5-1
	Module Maintenance.....	5-2
	General Troubleshooting Information.....	5-3
	Troubleshooting Alarm Conditions	5-4
Chapter 6	Customer Information	6-1

Contents, Continued

- Appendix A Module Parameter Descriptions..... A-1
 - Overview A-1
 - Operating Status Parameters..... A-2
 - Configurable Parameters A-3
 - Alarm Parameters A-4
 - Manufacturing Data Parameters..... A-5
- Glossary Glossary-1
- Index Index-1

Important Safety Instructions

Read and Retain Instructions

Carefully read all safety and operating instructions before operating this equipment, and retain them for future reference.

Follow Instructions and Heed Warnings

Follow all operating and use instructions. Pay attention to all warnings and cautions in the operating instructions, as well as those that are affixed to this equipment.

Terminology

The terms defined below are used in this document. The definitions given are based on those found in safety standards.

Service Personnel - The term *service personnel* applies to trained and qualified individuals who are allowed to install, replace, or service electrical equipment. The service personnel are expected to use their experience and technical skills to avoid possible injury to themselves and others due to hazards that exist in service and restricted access areas.

User and Operator - The terms *user* and *operator* apply to persons other than service personnel.

Ground(ing) and Earth(ing) - The terms *ground(ing)* and *earth(ing)* are synonymous. This document uses *ground(ing)* for clarity, but it can be interpreted as having the same meaning as *earth(ing)*.

Electric Shock Hazard

This equipment meets applicable safety standards.



WARNING!

To reduce risk of electric shock, perform only the instructions that are included in the operating instructions. Refer all servicing to qualified service personnel only.

Electric shock can cause personal injury or even death. Avoid direct contact with dangerous voltages at all times. The protective ground connection, where provided, is essential to safe operation and must be verified before connecting the power supply.

Know the following safety warnings and guidelines:

- **Dangerous Voltages**
 - Only qualified service personnel are allowed to perform equipment installation or replacement.
 - Only qualified service personnel are allowed to remove chassis covers and access any of the components inside the chassis.
- **Grounding**
 - Do not violate the protective grounding by using an extension cable, power cable, or autotransformer without a protective ground conductor.
 - Take care to maintain the protective grounding of this equipment during service or repair and to re-establish the protective grounding before putting this equipment back into operation.

Important Safety Instructions, Continued

Installation Site

When selecting the installation site, comply with the following:

- **Protective Ground** - The protective ground lead of the building's electrical installation should comply with national and local requirements.
- **Environmental Condition** - The installation site should be dry, clean, and ventilated. Do not use this equipment where it could be at risk of contact with water. Ensure that this equipment is operated in an environment that meets the requirements as stated in this equipment's technical specifications, which may be found on this equipment's data sheet.

Installation Requirements



WARNING:

Allow only qualified service personnel to install this equipment. The installation must conform to all local codes and regulations.

Equipment Placement



WARNING:

Avoid personal injury and damage to this equipment. An unstable mounting surface may cause this equipment to fall.

To protect against equipment damage or injury to personnel, comply with the following:

- Install this equipment in a restricted access location.
- Do not install near any heat sources such as radiators, heat registers, stoves, or other equipment (including amplifiers) that produce heat.
- Place this equipment close enough to a mains AC outlet to accommodate the length of this equipment's power cord.
- Route all power cords so that people cannot walk on, place objects on, or lean objects against them. This may pinch or damage the power cords. Pay particular attention to power cords at plugs, outlets, and the points where the power cords exit this equipment.
- Use only with a cart, stand, tripod, bracket, or table specified by the manufacturer, or sold with this equipment.
- Make sure the mounting surface or rack is stable and can support the size and weight of this equipment.
- The mounting surface or rack should be appropriately anchored according to manufacturer's specifications. Ensure this equipment is securely fastened to the mounting surface or rack where necessary to protect against damage due to any disturbance and subsequent fall.

Ventilation

This equipment has openings for ventilation to protect it from overheating. To ensure equipment reliability and safe operation, do not block or cover any of the ventilation openings. Install the equipment in accordance with the manufacturer's instructions.

Important Safety Instructions, Continued

Rack Mounting Safety Precautions

Mechanical Loading

Make sure that the rack is placed on a stable surface. If the rack has stabilizing devices, install these stabilizing devices before mounting any equipment in the rack.



WARNING:

Avoid personal injury and damage to this equipment. Mounting this equipment in the rack should be such that a hazardous condition is not caused due to uneven mechanical loading.

Reduced Airflow

When mounting this equipment in the rack, do not obstruct the cooling airflow through the rack. Be sure to mount the blanking plates to cover unused rack space. Additional components such as combiners and net strips should be mounted at the back of the rack, so that the free airflow is not restricted.



CAUTION:

Installation of this equipment in a rack should be such that the amount of airflow required for safe operation of this equipment is not compromised.

Elevated Operating Ambient Temperature

Only install this equipment in a humidity- and temperature-controlled environment that meets the requirements given in this equipment's technical specifications.



CAUTION:

If installed in a closed or multi-unit rack assembly, the operating ambient temperature of the rack environment may be greater than room ambient temperature. Therefore, install this equipment in an environment compatible with the manufacturer's maximum rated ambient temperature.

Handling Precautions

When moving a cart that contains this equipment, check for any of the following possible hazards:



WARNING:



Avoid personal injury and damage to this equipment! Move any equipment and cart combination with care. Quick stops, excessive force, and uneven surfaces may cause this equipment and cart to overturn.

- Use caution when moving this equipment/cart combination to avoid injury from tip-over.

Important Safety Instructions, Continued

- If the cart does not move easily, this condition may indicate obstructions or cables that may need to be disconnected before moving this equipment to another location.
- Avoid quick stops and starts when moving the cart.
- Check for uneven floor surfaces such as cracks or cables and cords.

Grounding

This section provides instructions for verifying that the equipment is properly grounded.

Safety Plugs (USA Only)

This equipment is equipped with either a 3-terminal (grounding-type) safety plug or a 2-terminal (polarized) safety plug. The wide blade or the third terminal is provided for safety. Do not defeat the safety purpose of the grounding-type or polarized safety plug.

To properly ground this equipment, follow these safety guidelines:

- **Grounding-Type Plug** - For a 3-terminal plug (one terminal on this plug is a protective grounding pin), insert the plug into a grounded mains, 3-terminal outlet.
Note: This plug fits only one way. If this plug cannot be fully inserted into the outlet, contact an electrician to replace the obsolete 3-terminal outlet.
- **Polarized Plug** - For a 2-terminal plug (a polarized plug with one wide blade and one narrow blade), insert the plug into a polarized mains, 2-terminal outlet in which one socket is wider than the other.
Note: If this plug cannot be fully inserted into the outlet, try reversing the plug. If the plug still fails to fit, contact an electrician to replace the obsolete 2-terminal outlet.

Grounding Terminal

If this equipment is equipped with an external grounding terminal, attach one end of an 18-gauge wire (or larger) to the grounding terminal; then, attach the other end of the wire to a ground, such as a grounded equipment rack.

Safety Plugs (European Union)

- **Class I Mains Powered Equipment** – Provided with a 3-terminal AC inlet and requires connection to a 3-terminal mains supply outlet via a 3-terminal power cord for proper connection to the protective ground.
Note: The equipotential bonding terminal provided on some equipment is not designed to function as a protective ground connection.
- **Class II Mains Powered Equipment** – Provided with a 2-terminal AC inlet that may be connected by a 2-terminal power cord to the mains supply outlet. No connection to the protective ground is required as this class of equipment is provided with double or reinforced and/or supplementary insulation in addition to the basic insulation provided in Class I equipment.
Note: Class II equipment, which is subject to EN 50083-1, is provided with a chassis mounted equipotential bonding terminal. See the section titled **Equipotential Bonding** for connection instructions.

Important Safety Instructions, Continued

Equipotential Bonding

If this equipment is equipped with an external chassis terminal marked with the IEC 60417-5020 chassis icon () , the installer should refer to CENELEC standard EN 50083-1 or IEC standard IEC 60728-11 for correct equipotential bonding connection instructions.

AC Power

Important: If this equipment is a Class I equipment, it must be grounded.

- If this equipment plugs into an outlet, the outlet must be near this equipment, and must be easily accessible.
- Connect this equipment only to the power sources that are identified on the equipment-rating label normally located close to the power inlet connector(s).
- This equipment may have two power sources. Be sure to disconnect all power sources before working on this equipment.
- If this equipment **does not** have a main power switch, the power cord connector serves as the disconnect device.
- Always pull on the plug or the connector to disconnect a cable. Never pull on the cable itself.
- Unplug this equipment when unused for long periods of time.

Connection to -48 V DC/-60 V DC Power Sources

If this equipment is DC-powered, refer to the specific installation instructions in this manual or in companion manuals in this series for information on connecting this equipment to nominal -48 V DC/-60 V DC power sources.

Circuit Overload

Know the effects of circuit overloading before connecting this equipment to the power supply.



CAUTION:

Consider the connection of this equipment to the supply circuit and the effect that overloading of circuits might have on overcurrent protection and supply wiring. Refer to the information on the equipment-rating label when addressing this concern.

General Servicing Precautions



WARNING:

Avoid electric shock! Opening or removing this equipment's cover may expose you to dangerous voltages.

Be aware of the following general precautions and guidelines:

- **Servicing** - Refer all servicing to qualified service personnel. Servicing is required when this equipment has been damaged in any way, such as power supply cord or plug is damaged, liquid has been spilled or objects have fallen into this equipment, this equipment has been exposed to rain or moisture, does not operate normally, or has been dropped.

Important Safety Instructions, Continued

- **Wristwatch and Jewelry** - For personal safety and to avoid damage of this equipment during service and repair, do not wear electrically conducting objects such as a wristwatch or jewelry.
- **Lightning** - Do not work on this equipment, or connect or disconnect cables, during periods of lightning.
- **Labels** - Do not remove any warning labels. Replace damaged or illegible warning labels with new ones.
- **Covers** - Do not open the cover of this equipment and attempt service unless instructed to do so in the instructions. Refer all servicing to qualified service personnel only.
- **Moisture** - Do not allow moisture to enter this equipment.
- **Cleaning** - Use a damp cloth for cleaning.
- **Safety Checks** - After service, assemble this equipment and perform safety checks to ensure it is safe to use before putting it back into operation.

Electrostatic Discharge

Electrostatic discharge (ESD) results from the static electricity buildup on the human body and other objects. This static discharge can degrade components and cause failures.

Take the following precautions against electrostatic discharge:

- Use an anti-static bench mat and a wrist strap or ankle strap designed to safely ground ESD potentials through a resistive element.
- Keep components in their anti-static packaging until installed.
- Avoid touching electronic components when installing a module.

Fuse Replacement

To replace a fuse, comply with the following:

- Disconnect the power before changing fuses.
- Identify and clear the condition that caused the original fuse failure.
- Always use a fuse of the correct type and rating. The correct type and rating are indicated on this equipment.

Lithium Battery

For equipment with a lithium battery, observe the following rules:

- Do not dispose of used batteries through the regular garbage collection system, but follow the local regulations. The batteries may contain substances that could be harmful to the environment.
- Replace batteries with the same or equivalent type recommended by Cisco.
- Insert batteries correctly. There may be a risk of explosion if the batteries are incorrectly inserted.
- When disposing of this equipment, remove the batteries and dispose of them separately in accordance with local regulations.
- Do not recharge the batteries or expose them to temperatures above 100°C (212°F).

Important Safety Instructions, Continued

Electromagnetic Compatibility Regulatory Requirements

This equipment meets applicable electromagnetic compatibility (EMC) regulatory requirements. EMC performance is dependent upon the use of correctly shielded cables of good quality for all external connections, except the power source, when installing this equipment.

- Ensure compliance with cable/connector specifications and associated installation instructions where given elsewhere in this manual.

Otherwise, comply with the following good practices:

- Multi-conductor cables should be of single-braided, shielded type and have conductive connector bodies and backshells with cable clamps that are conductively bonded to the backshell and capable of making 360° connection to the cable shielding. Exceptions from this general rule will be clearly stated in the connector description for the excepted connector in question.
- Ethernet cables should be of single-shielded or double-shielded type.
- Coaxial cables should be of the double-braided shielded type.

EMC

Where this equipment is subject to USA FCC and/or Industry Canada rules, the following statements apply:

FCC Statement for Class A Equipment

This equipment has been tested and found to comply with the limits for a Class A digital device, pursuant to Part 15 of the FCC Rules. These limits are designed to provide reasonable protection against harmful interference when this equipment is operated in a commercial environment.

This equipment generates, uses, and can radiate radio frequency energy and, if not installed and used in accordance with the instruction manual, may cause harmful interference to radio communications. Operation of this equipment in a residential area is likely to cause harmful interference in which case users will be required to correct the interference at their own expense.

Industry Canada – Industrie Canadienne Statement

This apparatus complies with Canadian ICES-003.
Cet appareil est conforme à la norme NMB-003 du Canada.

CENELEC/CISPR Statement with Respect to Class A Information Technology Equipment

This is a Class A equipment. In a domestic environment this equipment may cause radio interference in which case the user may be required to take adequate measures.

Important Safety Instructions, Continued

Modifications

This equipment has been designed and tested to comply with applicable safety, laser safety, and EMC regulations, codes, and standards to ensure safe operation in its intended environment.

Do not make modifications to this equipment. Any changes or modifications could void the user's authority to operate this equipment.

Modifications have the potential to degrade the level of protection built into this equipment, putting people and property at risk of injury or damage. Those persons making any modifications expose themselves to the penalties arising from proven non-compliance with regulatory requirements and to civil litigation for compensation in respect of consequential damages or injury.

Accessories

Use only attachments or accessories specified by the manufacturer.

Laser Safety

Introduction

This equipment contains an infrared laser that transmits intensity-modulated light and emits invisible radiation.

Warning: Radiation



WARNINGS:

- **Avoid personal injury! Use of controls, adjustments, or performance of procedures other than those specified herein may result in hazardous radiation exposure.**
 - **Avoid personal injury! The laser light source on this equipment emits invisible laser radiation. Avoid direct exposure to the laser light source.**
 - **Avoid personal injury! Viewing the laser output with optical instruments (such as eye loupes, magnifiers, or microscopes) within a distance of 100 mm may pose an eye hazard.**
- Do not apply power to this equipment if the fiber is unmated or unterminated.
 - Do not stare into an unmated fiber or at any mirror-like surface that could reflect light that is emitted from an unterminated fiber.
 - Do not view an activated fiber with optical instruments (e.g., eye loupes, magnifiers, microscopes).
 - Use safety-approved optical fiber cable to maintain compliance with applicable laser safety requirements.

Warning: Fiber Optic Cables



WARNING:

Avoid personal injury! Qualified service personnel may only perform the procedures in this manual. Wear safety glasses and use extreme caution when handling fiber optic cables, particularly during splicing or terminating operations. The thin glass fiber core at the center of the cable is fragile when exposed by the removal of cladding and buffer material. It easily fragments into glass splinters. Using tweezers, place splinters immediately in a sealed waste container and dispose of them safely in accordance with local regulations.

Laser Safety, Continued

Safe Operation For Software Controlling Optical Transmission Equipment

If this manual discusses software, the software described is used to monitor and/or control Cisco and other vendors' electrical and optical equipment designed to transmit video, voice, or data signals. Certain safety precautions should be observed when operating equipment of this nature.

For equipment specific safety requirements, refer to the appropriate section of the equipment documentation.

For safe operation of this software, refer to the following warnings.



WARNINGS:

- **Ensure that all optical connections are complete or terminated before using this equipment to remotely control a laser device. An optical or laser device can pose a hazard to remotely located personnel when operated without their knowledge.**
- **Allow only personnel trained in laser safety to operate this software. Otherwise, injuries to personnel may occur.**
- **Restrict access of this software to authorized personnel only.**
- **Install this software in equipment that is located in a restricted access area.**

Laser Safety, Continued

Maximum Laser Power

The maximum laser power that can be expected from this product is defined in the following table for various amplifier configurations.

Output Configuration	Maximum Output	IEC 60825-1 Product Classification	Accessible Radiation Level with Fibers removed "When Open"
8x22.5	22.5 dBm	1M	3B
10x21.5	21.5 dBm	1M	3B
12X20.7	20.5 dBm	1M	1M
14x20.0	20.0 dBm	1M	1M
16x19.5	19.5 dBm	1M	1M
18x18.9	18.9 dBm	1M	1M
20x18.5	18.5 dBm	1M	1M
22x18.1	18.1 dBm	1M	1M
24x17.65	17.65 dBm	1M	1M

Laser Warning Labels on Prisma II Optical Amplifiers

Prisma II Optical Amplifiers bear the following labels.



OR



Fiber Input





Scientific-Atlanta, Inc.
5030 Sugarloaf Parkway
Lawrenceville, GA
30044-2869



Part Number: 4008682
Model : P2-EDFA-FPST-16X19.5-LA
Manufactured: December, 2005
Assembled in USA
Manufacturing Site: SC

This product complies with 21 CFR 1040.10, except for deviations pursuant to Laser Notice No. 50, dated July 26, 2001.

INVISIBLE LASER RADIATION
DO NOT VIEW DIRECTLY
WITH OPTICAL INSTRUMENTS.
CLASS 1M LASER PRODUCT
PER IEC 60825-1 EDITION 1.2 2001

140mW MAXIMUM OUTPUT BETWEEN 1530 AND 1560nm



ATTENTION
Observe precautions for
handling electrostatic
sensitive devices



This device complies with part 15 of the FCC rules. Operation is subject to the following two conditions: (1) This device may not cause harmful interference, and (2) This device must accept any interference received, including interference that may cause undesired operation.

Laser Safety, Continued

Laser Warning Labels

The following illustration displays the location of the laser warning labels on this equipment.

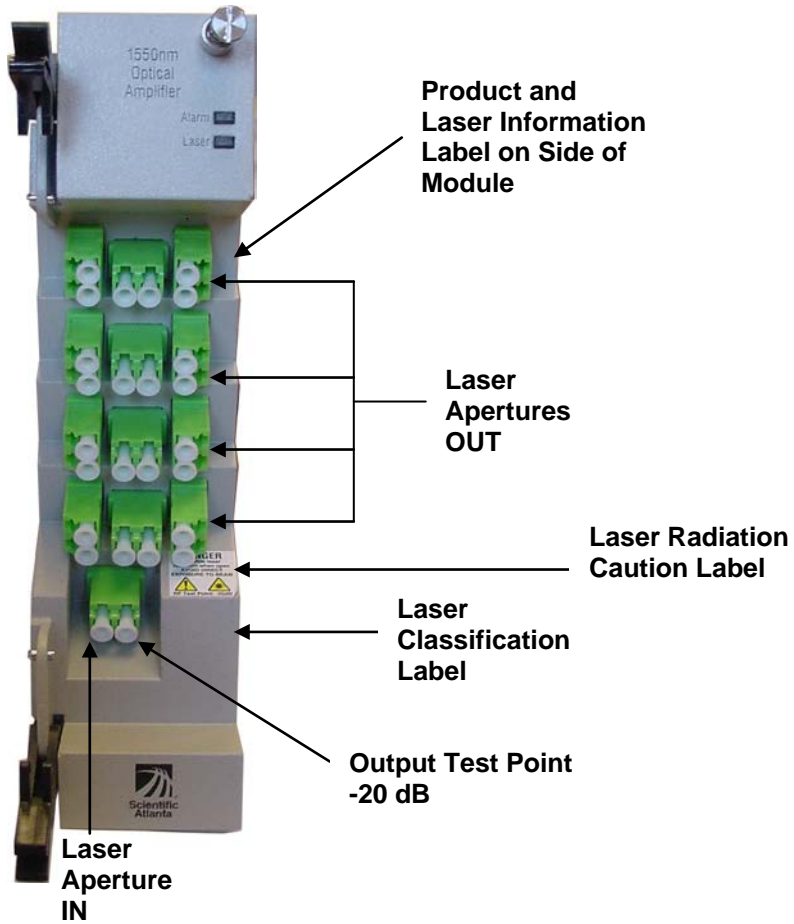

Chapter 1

Introduction

Overview

Introduction

This chapter describes the Prisma II™ Optical Amplifiers. This guide covers the following uncooled amplifier products.

- Prisma II Optical Post-Amplifier (8x22.5 dBm)
- Prisma II Optical Post-Amplifier (10x21.5 dBm)
- Prisma II Optical Post-Amplifier (12x20.7 dBm)
- Prisma II Optical Post-Amplifier (14x20.0 dBm)
- Prisma II Optical Post-Amplifier (16x19.5 dBm)
- Prisma II Optical Post-Amplifier (18x18.9 dBm)
- Prisma II Optical Post-Amplifier (20x18.5 dBm)
- Prisma II Optical Post-Amplifier (22x18.1 dBm)
- Prisma II Optical Post-Amplifier (24x17.65 dBm)

Installation procedures and most operational procedures are identical for all products.

Qualified Personnel

Only appropriately qualified and skilled personnel should attempt to install this product.



WARNING:

Allow only qualified and skilled personnel to install, operate, maintain, and service this product. Otherwise, personal injury or equipment damage may occur.

Who Should Use This Guide

This guide is intended for authorized personnel who have experience working with similar equipment. The personnel should have appropriate background and knowledge to complete the procedures described in this guide.

Overview, Continued

In This Chapter

This chapter contains the following topics.

Topic	See Page
Description	1-3
The Front Panel	1-5
The Back Panel	1-6
Configuration Overview	1-7

Description

Overview

The Prisma II optical network is an advanced transmission system designed to optimize network architectures and increase reliability, scalability, and cost effectiveness. The Prisma II Optical Amplifiers deliver both analog and digital signals. Microprocessor control allows ease of installation and flexibility of application.

This product may come configured as a single, double, or triple-wide module.

Features

The Prisma II Optical Amplifier has the following features:

- Front panel green light emitting diode (LED) to indicate operating status
- Front panel red LED to indicate alarm status
- Optical input/output connectors
- Plug-and-play capability
- Compatible with Intelligent Communications Interface Module (ICIM), Local Craft Interface (LCI) software, and Transmission Networks Control System (TNCS) software

Optical Amplifier Operation

Operating over a wide range of input powers from a Prisma II 1550 nm Transmitter or another 1550 nm Optical Amplifier upstream, the amplifier modules provide high-performance transmission of voice, video, and data signals for optical networking.

A system typically consists of a pre-amplifier followed by one or more post-amplifiers. The pre-amplifier accepts a relatively low optical input level and provides the relatively high optical input levels required by the post-amplifier. The pre-amplifier is covered in a separate Installation and Operation Guide. Both pre-amplifier and post-amplifier may be configured with a variety of output ports.

The module is controlled by an ICIM, the LCI software, TNCS, or ROSA software.

Description, Continued

Optical Output

The post-amplifier modules come standard with LC/APC Duplex connectors. Optical jumpers are sold separately to interconnect pre- and post-amplifier modules and to interconnect to other equipment that may have other optical connector types.



WARNING:

Avoid damage to your eyes! Do not look into any optical connector while the system is active. Even if the unit is off, there may still be hazardous optical levels present.

Double-Wide Post-Amplifier Module Block Diagram

A block diagram of double-wide post-amplifier modules is shown below.

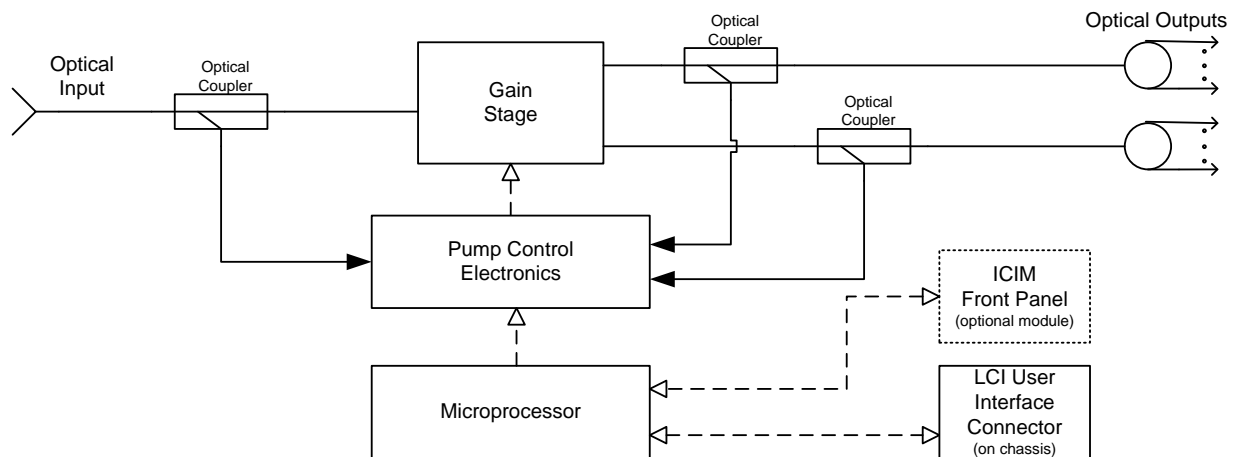

The Front Panel

Overview

The Prisma II Optical Amplifier front panel is designed with one input connector and one or more output connectors. ALARM and LASER indicators on the front panel allow you to monitor laser and alarm status at a glance.

The features of the front panel of the Prisma II Optical Amplifier are shown below.

Part	Function
Alarm Indicator	Illuminates or blinks when an alarm condition occurs.
Laser On Indicator	Illuminates when there is optical power present.
Optical Output	Connects the output signal to the optical cable.
Optical Input	Connects the input signal to the optical cable.

Optical Amplifier Illustration

The front panel of a Prisma II Optical Post-Amplifier is shown below.



The Back Panel

Back Panel Connectors

Blind-mate connectors make it easy to install this module. The push-on connector on the back of the module mates with the backplane connector inside the chassis. The 110-pin connector provides the following:

- Electrical power input connection
- Alarm communications
- Status-monitoring connections
- Communications and control connections



TP028

Power and Communications Connector

The power and communications connector on the back of the module mates with a connector inside of the chassis, and supplies power from the chassis to the optical amplifier. The 110-pin connector also routes alarm and status-monitoring information from the optical amplifier to the Prisma II Chassis.

Configuration Overview

Overview

The Prisma II Optical Amplifier is shipped from the factory with operational parameters set to factory defaults. However, you will probably choose to configure the operating parameters so that they are best suited for your application.

Configuration and Monitoring Methods

The Prisma II Optical Amplifier may be controlled using one of three different methods.

- The Prisma II ICIM

If an ICIM is installed in the Prisma II Chassis, it may be used to configure and monitor Prisma II application modules within its domain. For instructions on operating this module using the ICIM, refer to Chapter 3, **Operation Using the ICIM**.

- The LCI software

The LCI software running on a locally connected PC may be used to configure operating parameters of Prisma II modules. For instructions on operating this module using the LCI software, refer to Chapter 4, **Operation Using LCI**.

- The TNCS software

If the ICIM is installed, TNCS software may be used to configure and monitor all functions of the Prisma II modules. For instructions on operating this module using TNCS, see the manual that was shipped with the TNCS software, *TNCS Administrator Software User's Guide*, part number 730201.

Configuration Summary

For detailed information on configuring this module, see Chapter 3, **Operation Using the ICIM** or Chapter 4, **Operation Using LCI**.

Chapter 2 Installation

Overview

Introduction

This chapter contains instructions, site requirements, equipment, and tools needed to install the Prisma II Optical Amplifier.

In This Chapter

This chapter contains the following topics.

Topic	See Page
Preparing for Installation	2-2
Site Requirements	2-3
Installing the Module in the Chassis	2-6
Connecting Optical Cables	2-8
Connecting the ICIM to Additional Chassis	2-12
Connecting the Chassis to the TNCS Server	2-13
External Alarms Connections	2-15

Preparing for Installation

Overview

Before you begin, make sure that the module is in good condition and that you have the tools and equipment listed here.

Unpacking and Inspecting the Module

As you unpack the module, inspect it for shipping damage. If you find any damage, contact Cisco Services.

Equipment and Tools Needed

Before you begin, make sure that the module is in good condition. You need the following equipment and tools to install these modules.

You need . . .	To . . .
a Prisma II Chassis with power supply	provide housing, power and input/output connections to the module.
3/8-in. flat-blade screwdriver	secure the module in the chassis.
optical cables with connectors	carry optical input and output signals.

Site Requirements

Overview

Before you begin, make certain that your installation site meets the requirements discussed in this section.

Access Requirements

Ensure that only authorized personnel have access to this equipment. Otherwise, personal injury or equipment damage may occur.



WARNING:

Use this product in locations that restrict access to all persons who are not authorized. Otherwise, personal injury or equipment damage may occur.

Equipment Rack

To install this module, your site must be equipped with an Electronics Industry Association (EIA) equipment rack that properly houses the Prisma II Chassis with proper spacing for air circulation. For instructions on installing the chassis in the rack, refer to the guide that was shipped with the chassis.

Operating Environment



CAUTION:

Avoid damage to this product! Operating this product above the maximum operating temperature specified voids the warranty.

Follow these recommendations to maintain an acceptable operating temperature.

- Temperature inside the rack must be between -5°C and 55°C (23°F and 131°F)
- Keep cooling vents and air filters clear and free of obstructions.
- Provide ventilation, as needed, using one or more of the following methods.
 - air-deflecting baffles
 - forced-air ventilation
 - air outlets above enclosures

Site Requirements, Continued

Power Requirements

All Prisma II modules receive their electrical power from the Prisma II Chassis. The modules may be installed with the chassis powered-up.

Space Requirements

Prisma II High power Optical Amplifiers are double-wide modules. They are usually installed in slots 5 through 15. Slots 1 through 4 are usually reserved for the power supplies. Slots 15 and 16 are reserved for the ICIM, if installed. If an ICIM is not installed, any other module could be installed in these slots. Slot 2 and slot 4 are reserved for an internal power supply.

Chassis Style

The Prisma II Chassis may be configured with front or rear connectors depending on the system you have purchased. Power, RF input/output, and other connectors may be located on either the front or rear of the Prisma II Chassis. Connections to the chassis serve the same function and are made in the same manner regardless of the location of the connectors or chassis configuration.

Site Requirements, Continued

Rear Access Chassis Illustration

The Prisma II Chassis may be configured with front or rear connectors depending on the system you have purchased. The rear access chassis is shown here.

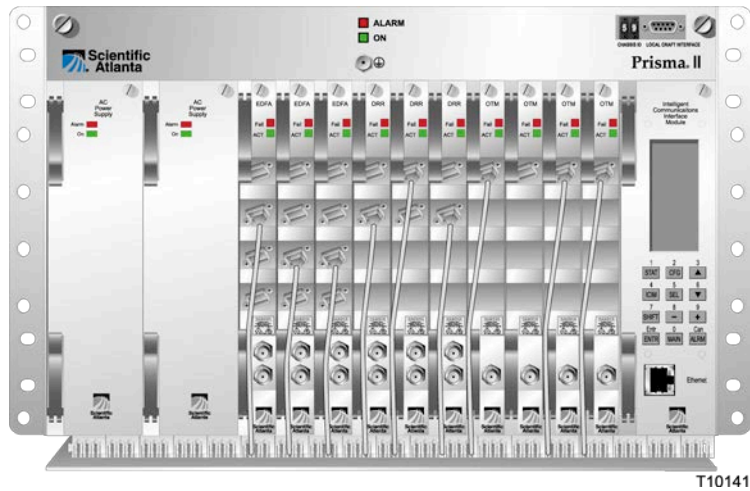

T10141

Front Access Chassis Illustration

The front access chassis is shown here.

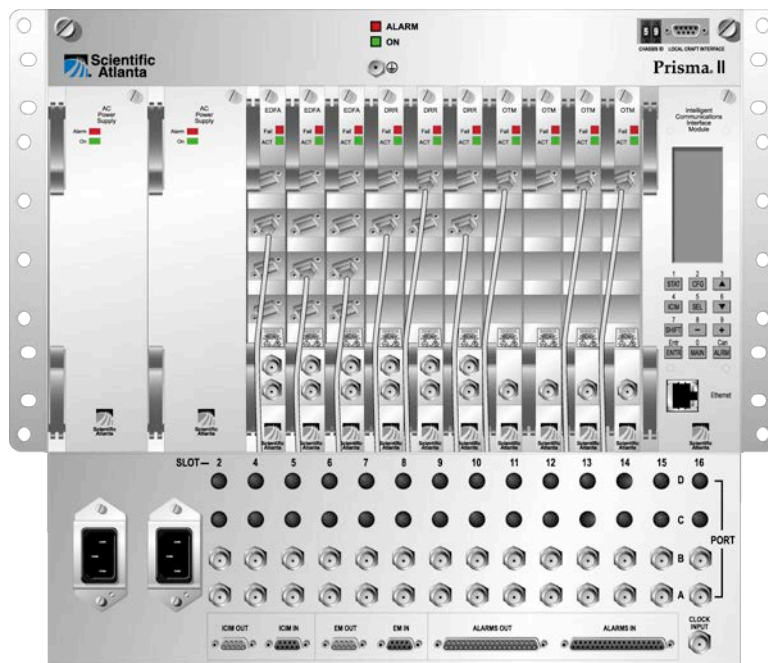

T10142

Installing the Module in the Chassis

Installing the Module

Important: The following procedure assumes the Prisma II Chassis is mounted in a rack. This procedure applies to both chassis styles.



WARNING:

Avoid damage to your eyes! Do not look into optical connectors while this module is active.

To install the module in the chassis, follow these steps.

1. Locate the fiber guides at the bottom of the chassis and the module guide slots inside the chassis as shown in the following illustration.

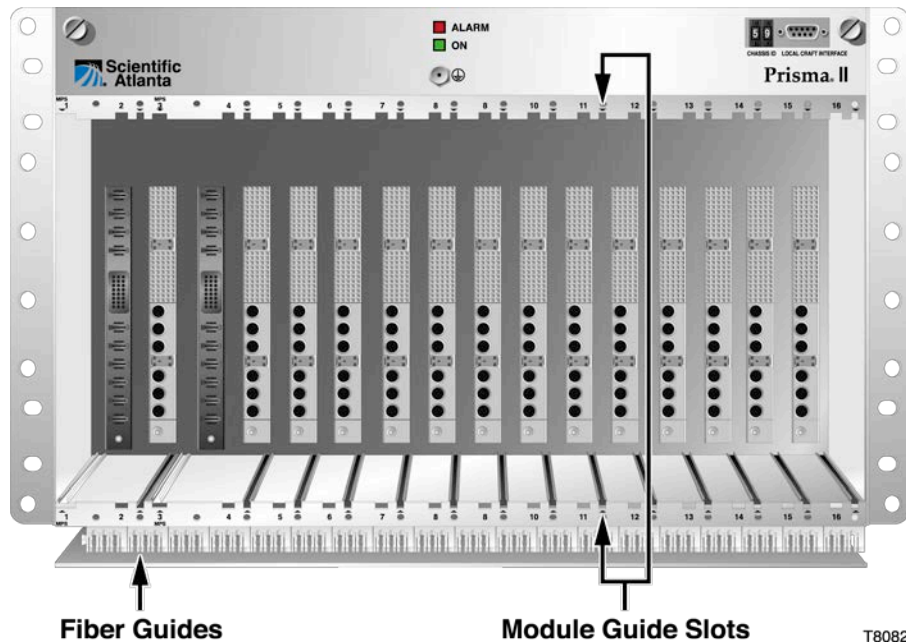

2. Align the ridges on the top and bottom of the module with the module guide slots located on the chassis. Module ejectors must be fully extended when inserting the module.

Installing the Module in the Chassis, Continued

3. Gently slide the module into the chassis until you feel the power and communications connections on the back of the module join connectors on the backplane. Use the module ejectors on the left side of the module to lock the module in place.

Do not force or bang the module into the chassis. If properly aligned, it should slide in with minimal force.

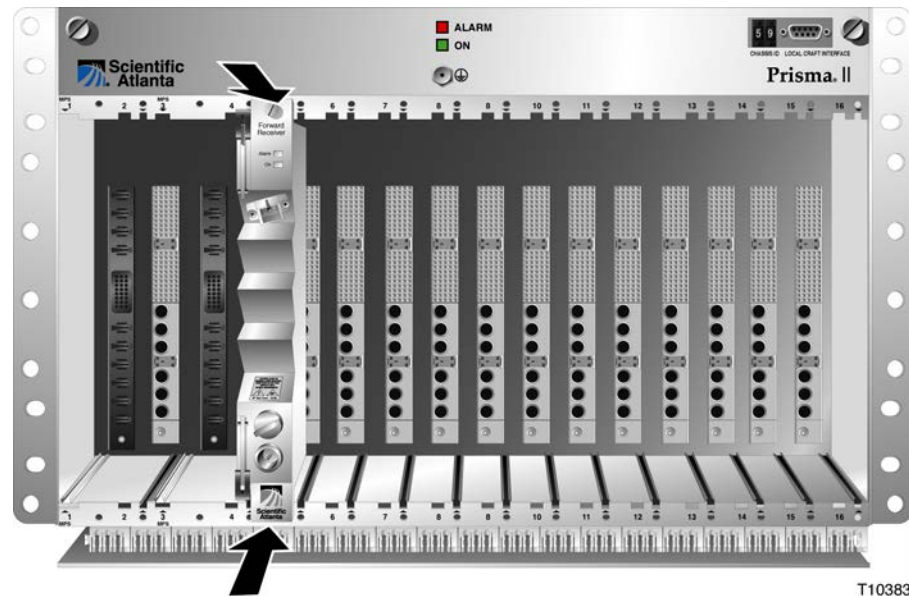

4. Secure the module by pressing the two ejector levers located on the left side of the module until they lock. When the levers are locked, the power and communications connections at the rear of the module mates with the communications connectors at the rear of the chassis slot.
5. Hand-tighten the screw at the top of the module, to secure it in the chassis. Use a $\frac{3}{8}$ -in. flat-blade screwdriver to secure. **Do not over tighten.**

Connecting Optical Cables

The Fiber Fish Tool

The Fiber Fish tool that was shipped along with the Prisma II Chassis is used to pull an optical cable from the rear of the chassis to the front of the chassis so the optical cables can be connected to optical connectors on the front panel of Prisma II modules.

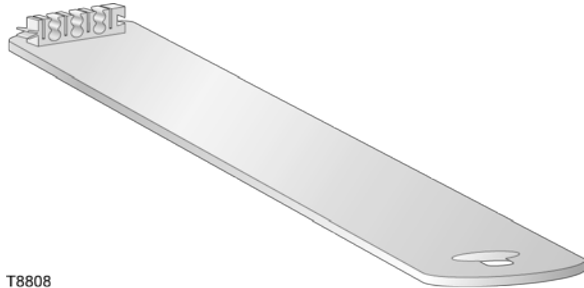

T8808

The Fiber Fish Tool Hook

At the end of the Fiber Fish tool is a small hook that allows you to hold an optical cable so that you can pull it through to the front panel of Prisma II Chassis.

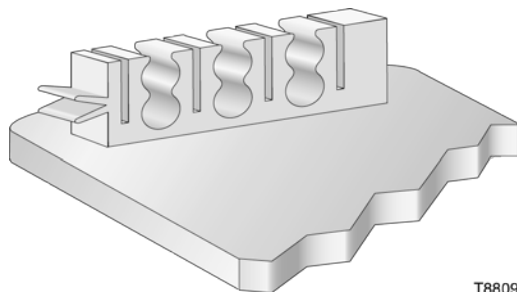

T8809

Connecting Optical Cables, Continued

Using the Fiber Fish to Pull the Optical Cable to the Prisma II Module

Important: Use a protective cap to protect the end of the fiber while the fiber is being fished (or handled in general).

To pull the optical cable to the module, follow these steps.

1. Insert the Fiber Fish tool through the slot located just above the bottom of the chassis.
2. At the rear of the chassis, locate the appropriate optical cable.
3. Insert the optical cable into notched area of the Fiber Fish tool as shown.

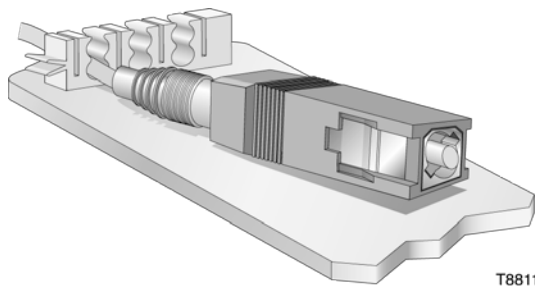

4. At the front of the chassis, pull the Fiber Fish tool (with cable attached) to the front of the chassis.
5. Disengage the optical cable from the Fiber Fish tool and attach to the appropriate connector on desired module. See **Cable Connection Procedure**.

Cleaning Optical Connectors

Cleaning fiber-optic connectors can help prevent interconnect problems and therefore aid system performance. When optical connectors are disconnected and reconnected, the fiber surface can become dirty or scratched. The goal of cleaning the fiber optic connectors is to remove all dust and contaminants without leaving any residue.

Required Equipment

The following equipment is required to clean the ends of fiber-optic connectors.

- Optical-grade (91%) isopropyl alcohol
- Lint-free wipes
- Compressed air (also called “canned air”)

Connecting Optical Cables, Continued

Tips for Optimal Fiber-Optic Connector Performance

Follow these guidelines to ensure optimal connector performance.

- Do not connect or disconnect optical connectors while optical power is present.
- Always use compressed air before cleaning the fiber-optic connectors.
- Use end caps on connectors when they are not in use.
- Always use compressed air to clean the end caps.
- Use optical-grade isopropyl alcohol of at least 91% or greater. Anything less than 91% isopropyl may leave a film on the fiber surface, creating more problems.
- Do not contaminate your alcohol supply.
 - Use a sprayer (a fountain pump is also adequate)
 - Do not put used alcohol back into the main container
- Use only lint-free wipes. Never use “Kleenex-type” tissues.
- If you have any degraded signal problems, clean the fiber-optic connector.

Cleaning Optical Connectors

Follow these steps to clean an optical connector.

1. Remove loose dirt or dust from the end of the connector by using compressed air (canned air) to blow dirt off the fiber and the connector.
2. Dampen a lint-free wipe with optical-grade (91%) isopropyl alcohol. If no wipes are available, use ferrule cleaner, part number 468517.
3. Clean the end of the connector using the lint-free wipe or ferrule cleaner.
4. Inspect the end of the connector for obvious contamination.
5. Mate the connector with an adapter or cover with an end cap.

Cable Connection Procedure

Important: It is recommended to make all connections with the optical power off. This will reduce the risk of damage to the fiber.

Note: Observe laser safety precautions. Refer to **Laser Safety** earlier in this guide.

Follow this procedure to make the optical cable connections for each module to be installed.

Connecting Optical Cables, Continued

⚠ CAUTION:

High power density exists on fiber when optical power is present. To avoid microscopic damage to fiber mating surfaces, turn off optical power before making or breaking optical connections.

1. After cleaning the end of the fiber, connect the optical output cable(s) to the top connector(s).

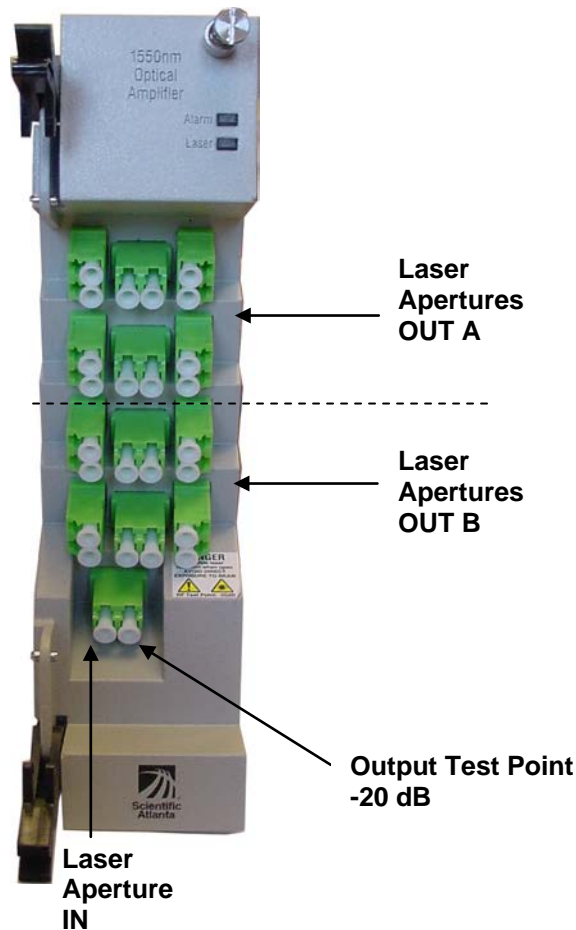

2. After cleaning the end of the fiber, attach the optical cable from the optical source to the input connector (bottom) of the module. This is the optical input connection.
3. Route the output cable(s) to the appropriate destination.

Connecting the ICIM to Additional Chassis

Chassis-to-Chassis ICIM Connections

The Prisma II platform allows the ICIM to be located in one chassis and control application modules located in several other chassis. This communication “daisy-chain” can be enabled by connecting cables to the **ICIM IN** and **ICIM OUT** connectors located on the connector interface panel of the chassis. This connection is required if an ICIM in one chassis is to communicate with or control any application module located in a separate chassis.

Note: An ICIM can control a maximum of 140 modules. Depending on your application, this is typically 6 or 7 chassis to a rack. Do not exceed these limits.

ICIM IN and ICIM OUT Connectors

Every Prisma II Chassis has a DB9 **ICIM IN** and a DB9 **ICIM OUT** connector for the purpose of chassis-to-chassis ICIM connections. **ICIM OUT** is a male connector and **ICIM IN** is a female connector.

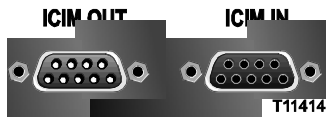

ICIM IN and ICIM OUT Cables

The cable required for both **ICIM IN** and **ICIM OUT** connections is a standard serial extension cable, DB9 Female to DB9 Male. This cable can be purchased at your local computer store or from the factory.

The part number for a 6-foot DB9 Female to DB9 Male serial extension cable is 180143. The connectors are a serial 9-pin D-shell (EIA 574/232).

ICIM IN and ICIM OUT Cable Connection Procedure

To make chassis-to-chassis **ICIM IN** and **ICIM OUT** connections, follow these steps.

1. Connect the serial extension cable from the **ICIM OUT** of the chassis containing the ICIM to the **ICIM IN** connector of the second chassis.
2. Connect a serial extension cable from the **ICIM OUT** of the second chassis to the **ICIM IN** of the third chassis.
3. Continue this “daisy-chain” connection until all chassis are connected.

Notes: All chassis connected in this “daisy-chain” must be powered and have a fan tray installed. A chassis that is connected but is either not powered, or does not have a fan tray installed, will cause faulty operation of the ICIM.

All chassis connected in this “daisy-chain” must have a unique chassis ID number.

Connecting the Chassis to the TNCS Server

Connecting a Prisma II Chassis to the TNCS Server Using the EM Connectors

Connecting the Prisma II Chassis to the TNCS server requires two special cable kits that are available from the factory.

- The RS-485 cable kit, part number 735748, includes the following:
 - 4 ea. Breakout boxes
 - 4 ea. RS-485 cable assemblies (50')
 - 4 ea. Breakout box mounting brackets
 - 100 ea. 6-32 screws (1.25")
- The Prisma II cable kit, part number 738686, includes the following:
 - 4 ea. Prisma II cable assemblies

The RS-485 cable kit is used to communicate with the RS-485/422/TTL devices.

EM IN to TNCS Connection

To connect TNCS to a Prisma II Chassis, follow these steps.

1. Mount one of the breakout boxes (included in the RS-485 cable kit) in a rack location central to the appropriate Prisma II Chassis.



2. Connect a RS-485 cable assembly (included in the RS-485 cable kit) from the breakout box to the **RS-485 COM** port on the TNCS server.
3. Connect one Prisma II cable assembly (included in the Prisma II cable kit) from the breakout box to the **EM IN** port of each Prisma II Chassis containing an ICIM.

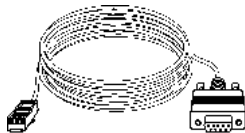

Note: As a general rule, it is recommended that the total number of ICIMs connected to any single COM port on the TNCS server be limited to four (4). However, you may connect more than four ICIMs per TNCS COM port as long as the total number of devices (modules) monitored by a single COM port does not exceed four-hundred (400) *and* the total number of devices monitored by any single ICIM does not exceed 140.

Connecting the Chassis to the TNCS Server, Continued

Using TNCS with Multiple Prisma II Chassis

All chassis within an ICIM domain are connected in series via the ICIM IN/OUT connectors using standard serial extension cable, DB9 Female to DB9 Male. Using the EM IN/OUT connectors, a chassis with an ICIM installed is connected to a breakout box as shown below. The breakout box is connected to the TNCS server with the cable included in the RS-485 cable kit.

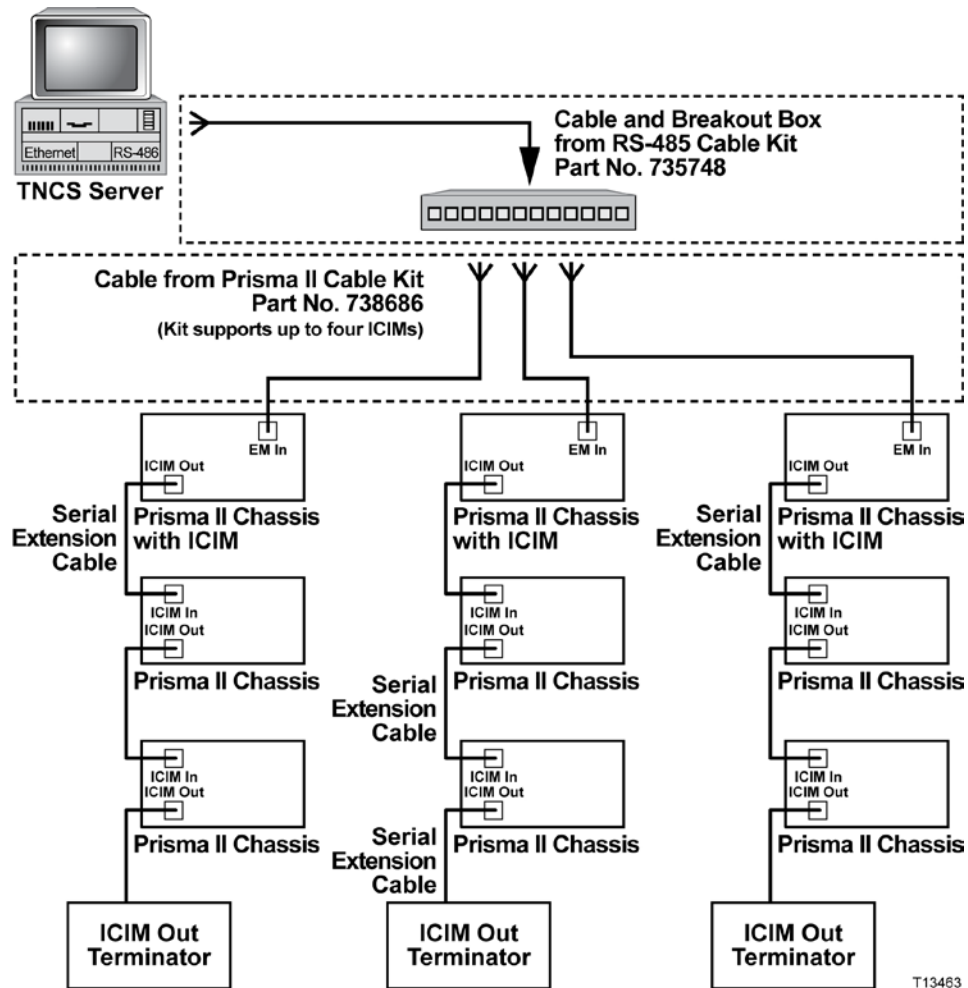

T13463

External Alarms Connections

Master/Slave Operation

All Prisma II modules ship from the factory configured as a "Master." The ICIM or the LCI or TNCS software can be used to reconfigure a module as a "Slave" or as redundant. The Prisma II Chassis allows for local hard-wired redundancy by using the **ALARM IN** and **ALARM OUT** connectors located on the connector interface panel. You can configure a pair of modules so that if the master fails, the slave takes over by using the **ALARM IN** and **ALARM OUT** connectors.

ALARMS IN and ALARMS OUT Connections

The Prisma II Chassis provides two connections for external alarms to and from each module slot. These alarm connections are located in two 37-pin D-connectors (DB-37) and are labeled **ALARMS IN** and **ALARMS OUT**. See the section titled **Alarms Connectors** in Chapter 2 of the *Prisma II Chassis Installation and Operation Guide*, part number 713375.

When a critical alarm occurs in a master module, the master turns off and the slave (redundant module) is enabled. To make that happen, the pin representing the master module's slot in the **ALARM OUT** connector must be externally wired to the pin representing the slave module's slot in the **ALARM IN** connector. Once those contacts are wired, care must be taken to ensure that the master and slave modules are not moved to other slots. Otherwise, the **ALARM IN** and **ALARM OUT** connectors will need to be rewired to the appropriate pins.

Notes:

- Any device configured as a master ignores its **ALARM IN** contacts.
- To verify proper wiring and redundant configuration, simply unplug the master device and observe that the slave module turns on. For detailed information on **ALARM IN** and **ALARM OUT** connectors, see the section titled **Alarms Connectors** in Chapter 2 of the *Prisma II Chassis Installation and Operation Guide*, part number 713375.

ALARMS IN and ALARMS OUT Connector Illustrations

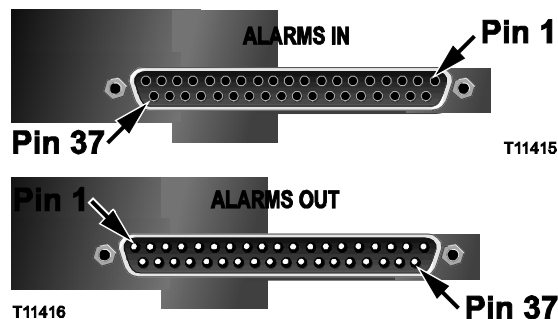

External Alarms Connections, Continued

Master/Slave Illustration

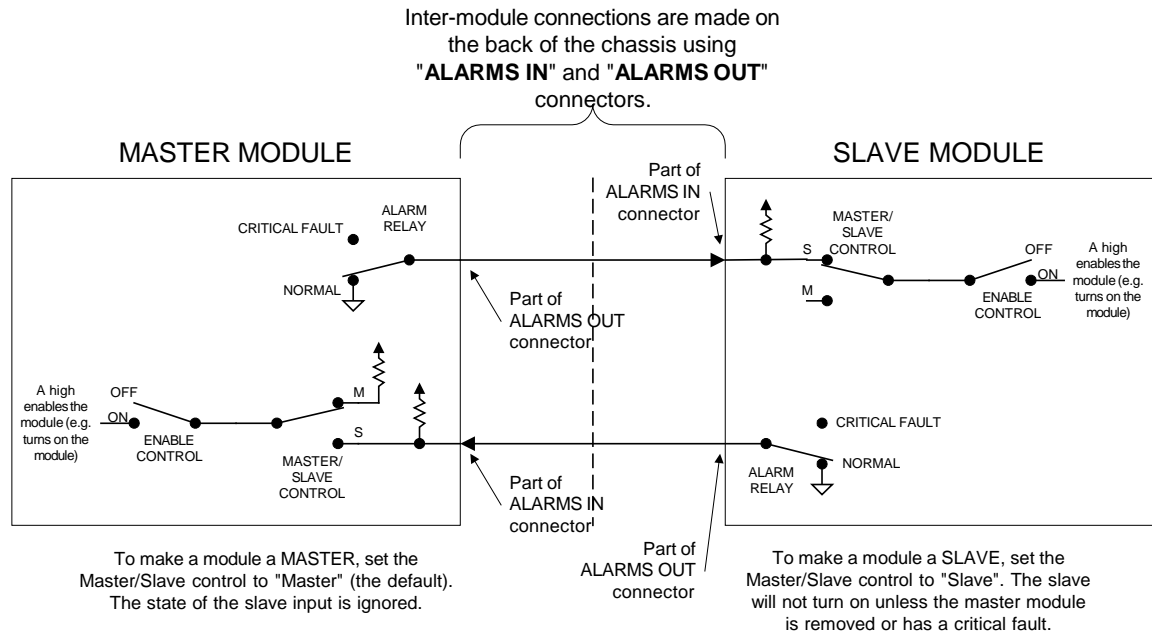

Prisma II Redundancy Interface Panel

The Prisma II Redundancy Interface Panel is an accessory to the Prisma II platform. It is intended to be used with the master/slave feature and the contact closure alarm feature of the Prisma II platform.

The Prisma II Redundancy Interface Panel serves as an extension to the two DB-37 connectors labeled **ALARM IN** and **ALARM OUT** on the connector interface panel of the Prisma II Chassis. The terminals on the redundancy interface panel are extensions of pins on the **ALARMS OUT** and **ALARMS IN** connectors on the Prisma II Chassis.

Refer the section titled **The Prisma II Redundancy Interface Panel** in Chapter 2 of the *Prisma II Chassis Installation and Operation Guide*, part number 713375.

Chapter 3

Operation Using the ICIM

Overview

Introduction

The procedures in this chapter apply if you are using the Prisma II ICIM to configure and operate the Prisma II Optical Amplifiers.

Scope of this Chapter

Included in this chapter are descriptions of the ICIM front panel and the ICIM liquid crystal display (LCD), and detailed procedures on how to use the software menus to configure the optical amplifier.

In This Chapter

This chapter contains the following topics.

Topic	See Page
ICIM Introduction	3-2
The ICIM Front Panel	3-3
The ICIM Password	3-6
Operating the ICIM	3-13
Monitoring Operating Status Using the ICIM	3-17
Configuring the Optical Amplifier Using the ICIM	3-19
Checking Optical Amplifier Alarms Using the ICIM	3-21
Checking Manufacturing Data Using the ICIM	3-25
Using the ICIM to Save the Configuration	3-27
SNMP Configuration Capability	3-28
Community Names	3-32
Setting SNMP Trap Receiver Parameters	3-33
New SNMP Variables	3-34
Boot Dialog for ICIM/SNMP Configuration	3-36
New Procedure for Adjusting Alarm Thresholds	3-41

ICIM Introduction

Laser Warning



WARNING:

Avoid damage to your eyes! Do not look into any optical connector while the system is active. Even if the unit is off, there may still be hazardous optical levels present.

ICIM Function

The ICIM functions as the module-user interface as well as the interface between the Prisma II modules and the Transmission Networks Control Systems (TNCS). The ICIM allows local module configuration and status monitoring for up to 140 modules located in multiple chassis. The ICIM features easy-to-use software that is navigated using the numeric keypad and the LCD display.

Important: Do not operate any Prisma II Chassis without a fan tray installed properly. If a fan tray is not installed in the Prisma II Chassis, the ICIM will not communicate with any of the modules in that chassis.

Important: All chassis connected in a “daisy-chain” must be powered and have a fan tray installed. A chassis that is connected but is either not powered, or does not have a fan tray installed will cause faulty operation of the ICIM.

Important: All chassis connected in this “daisy-chain” must have a unique chassis identification (I.D.) number.

ICIM Block Diagram

The ICIM is illustrated in the block diagram below.

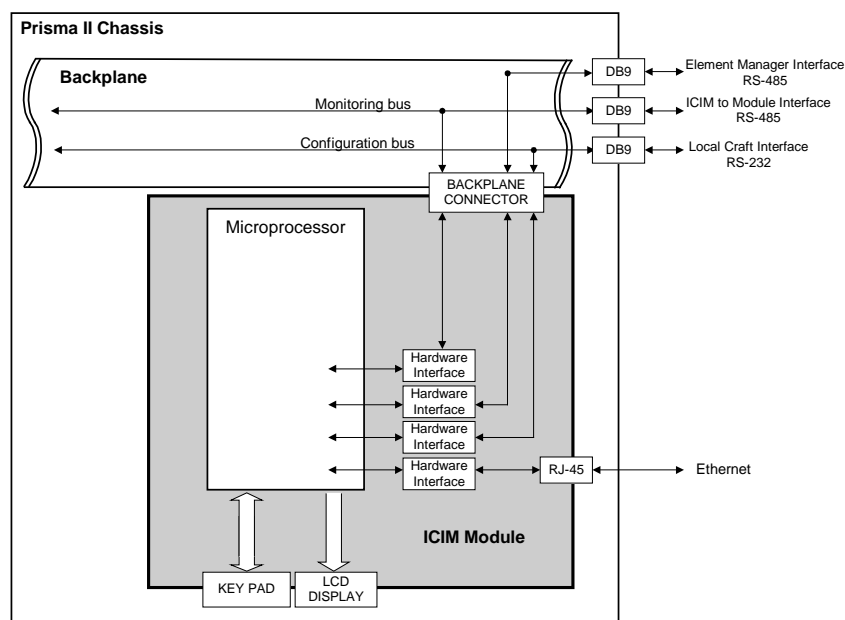

The ICIM Front Panel

ICIM Front Panel Illustration

The following illustration shows the front panel of the ICIM.

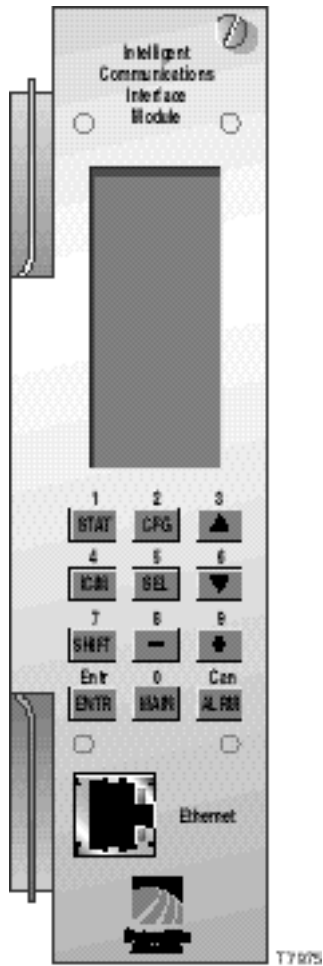

The ICIM Front Panel, Continued

ICIM Front Panel Features

Part	Function
LCD screen	Displays the ICIM menus, alarms, and status information.
12-key numeric keypad	Used to navigate the ICIM menus and configure the application modules.
Ethernet Connector	Directly connects the ICIM to a network (future release).

The ICIM LCD

The ICIM LCD is the operator's visual link to the ICIM software. When the ICIM is installed and powered up, the **MAIN** menu appears on the LCD. The following illustration shows the ICIM **MAIN** menu.

MAIN

Offline

Modules
15

Alarms
0













Scroll

Module
Shelf
Slot

The ICIM Front Panel, Continued

The ICIM Keypad

The ICIM keypad has twelve keys that allow you to input and monitor operational parameters. The table below lists each key and a brief description of its function.

Button	Function
	Displays status information for the selected module.
	Displays configuration information for the selected module.
	Displays all of the parameters in alarm for a selected module.
	Moves the menu selection area up. Also increases numerical readings of selected configuration parameters.
	Moves the menu selection area down. Also decreases numerical readings of selected configuration parameters.
	Selects the highlighted parameter.
	Displays ICIM module information such as firmware version, serial number, and baud rate.
	Shifts function of a keypad button to the function or number label just above that button.
	Decreases numerical readings of selected configuration parameters.
	Increases numerical readings of selected configuration parameters.
	Enters input data (if valid).
	Exits the current menu and displays the MAIN ICIM menu.

The ICIM Password

Introduction

The ICIM allows you to send configuration commands, to change alarm thresholds, and restore factory default settings in Prisma II modules. In order to ensure that no unauthorized changing of these parameters occurs, you have the option of using a password protection system. Password authorization only applies to the configurable parameters. Status and alarm information is always available on the ICIM regardless of password implementation.

Password Protection System

The table below shows the ICIM menu options available in the password protection system.

ICIM Menu Option	Description
User Psw	A user-settable password. <ul style="list-style-type: none">• Created, entered, and changed by the system operator(s)• Must be exactly eight digits, using only the 0-9 number keys
Change Psw	Changes an existing user password.
Disable Psw	Disables the user password function.
SA Psw	A service password that is used by factory personnel only.

Important: If you only want to monitor status and alarm data, simply skip the password function when it appears on the ICIM menu. You can access all module status and alarm information without a password. However, once a user password is entered, you are required to enter it every time you want to set configurable parameters to any module controlled by that ICIM. See **Expired Password or Inactive Password Messages** and **Entering the User Password** that follow.

The ICIM Password, Continued

Accessing the Password Menu

The Password menu allows you to create, enter, change, or disable the user password. It also allows service personnel to use factory password. To access the Password menu, follow the steps below.

1. Press the **ICIM** key.
2. Use the **▼** key to scroll down until **Password** is highlighted.
3. Press the **SEL** key. The Password menu appears. **User Psw** is highlighted.

MAI N	ICIM	ICIM	ICIM
-----	-----	-----	-----
Off line	Shelf 0	vhelf 7	Shelf 0
-----	Slot 15	Slot 15	Slot 15
-----	-----	-----	-----
Modules	Mfg Data	Mfg Data	User Psw
0	-----	-----	-----
Alarms	-----	-----	SA Psw
0	-----	-----	-----
-----	-----	-----	-----
Scroll	Password	Password	Change Psw
-----	-----	-----	-----
Module	Update Adr	Update Adr	Disable
Shelf	-----	-----	Psw
Slot	-----	-----	-----

Expired Password or Inactive Password Messages

The entry of a valid password allows changes to system parameters for a period of 10 minutes. If more than 10 minutes has passed since your last keystroke, and you attempt to make any changes to system parameters, the menu displays **Psw Expired**. If, after more than 10 minutes, you attempt to disable the password the menu displays **Failed, Password Not Active**. If either of these messages appears, you are required to re-enter the password. To re-enter the password, follow the procedure in the next section, **Entering the User Password**.

The ICIM Password, Continued

Entering the User Password

If you wish to use the user password feature, you must create and enter a password of exactly eight digits using only the 0-9 number keys. The password remains active for 10 minutes after your last keystroke. If you want to change configuration parameters after more than 10 minutes, you are required to re-enter your password.

Follow these steps to enter a user password.

1. Access the Password menu as shown earlier in **Accessing the Password Menu**.
2. Press the **SEL** key.

Result: The user password menu appears.

3. When **User Psw/Shift Off** appears, press the **SHIFT** key to display **Shift On** - then enter the eight digits of your password, using the 0-9 number keys.

If at any time you input a digit that is incorrect or you wish to change a digit, use the **CAN** (Cancel) function by pressing the **ALRM** key to delete that digit.

4. Press the **ENTER** key to enter the password.

Results:

- The ICIM updates the display to show if your password entry was accepted or rejected.
- If the entry was accepted, you are able to return to the MAIN menu.

The ICIM Password, Continued

5. If the password you entered is rejected, press the **SHIFT** key to return to the password menu, then re-enter an 8-digit password using only the 0-9 number keys. Press the **ENTER** key to input the password.

Reasons for a password to be rejected include:

- Entering more than eight digits for the password.
- Pressing keys other than the 0-9 number keys.
- Entering an incorrect password if a valid password has been entered.



ICIM	ICIM	ICIM	ICIM
Shelf 0 Slot 15	Shelf 0 Slot 15	Shelf 0 Slot 15	Shelf 0 Slot 15
User Psw	User Psw *****	User Psw 1234****	User Psw 12345678
Shift Off	Shift On	Rejected Shift Off	Accepted Shift Off

The ICIM Password, Continued

Changing the User Password

If a user password has been entered, it may be changed. However, the current password must be active prior to changing it. If the current password has expired (more than 10 minutes have passed since your last keystroke), you must re-enter the current password before changing to a new one.

Follow these steps to change a user password.

1. Access the Password menu as shown in the procedure **Accessing the Password Menu**.
2. Use the  key to scroll down until **Change Psw** is highlighted.
3. Press the  key to select **Change Psw**.
4. When **Change Psw/Shift Off** appears, press the  key to display **Shift On** - then enter the eight digits of your new password, using the 0-9 number keys.

If at any time you input a digit that is incorrect or wish to change a digit, use the **CAN** (Cancel) function by pressing the  key to delete that digit.

5. Press the  key to input the new password.

Results:

- The ICIM updates the display to show if your password entry was accepted or rejected.
- If the entry was accepted, you are able to return to the MAIN menu.

The ICIM Password, Continued

6. If the new password you entered is rejected, press the **SHIFT** key to return to the password entry menu. Clear all digits using the **CAN** (Cancel) function, then re-enter an 8-digit password using only the 0-9 number keys. Press the **ENTER** key to input the password.

ICIM	ICIM	ICIM	ICIM
----- Shelf 7 Slot 15 ----- User Psw ----- SA Psw ----- Change Psw ----- Disable Psw	----- Shelf 7 Slot 15 ----- Change Psw ----- ----- Shift Off	----- Shelf 7 Slot 15 ----- Change Psw ***** ----- ----- Shift On	----- Shelf 7 Slot 15 ----- Change Psw 87654321 ----- ----- Shift On

The ICIM Password, Continued

Disabling the User Password

If a user password has been entered, you may disable it at any time. However, the current password must be active prior to disabling it. If the current password has expired (more than 10 minutes have passed since your last keystroke), you must re-enter the current password before disabling it.

Follow these steps to disable a user password.

1. Press the **ICIM** key.
2. Use the **▼** key to scroll down until **Password** is highlighted.
3. Press the **SEL** key.
4. Use the **▼** key to scroll down until **Disable Psw** is highlighted.
5. Press the **SEL** key to select **Disable Psw**.
6. If the current password is active, the menu displays **Password Is Now Disabled**. You can now make changes to parameters without any password.
7. If the current password has expired (more than 10 minutes have passed since your last keystroke), the menu displays **Failed, Password Not Active**. You must re-enter the current password and then repeat this procedure.

ICIM	ICIM	ICIM
Shelf 7	Shelf 7	Shelf 7
Slot 15	Slot 15	Slot 15
User Psw	Enter Psw	Enter Psw
SA Psw	8765****	87654321
Change Psw	Password Is Now Disabled	Failed, Password Not Active
Disable Psw	Shift Off	Shift Off

Operating the ICIM

Using the ICIM

Once the module is installed as described in Chapter 2, it runs without the aid of an operator. Unless alarms are generated or your system configuration changes, you should not need to make any adjustments to the module beyond the initial setup.

Accessing the ICIM LCD Contrast

To access the ICIM LCD contrast control from the MAIN menu, press the **ICIM** key. Use the **+** key to increase or the **-** key to decrease ICIM display contrast.

The MAIN Menu

A few seconds after power-up, the MAIN menu (shown below) appears. Press the **SEL** key to select the specific option.

Display	Description
Offline	Indicates TNCS communication status with the ICIM.
Modules	Indicates the number of modules in the ICIM domain.
Alarms	Displays the number of modules that are in alarm. Selecting this option allows scrolling through all modules in alarm condition.
Scroll	Allows scrolling through all modules in the ICIM domain.
Module Shelf Slot	Allows selection of any specific module in the ICIM domain.

MAIN

Offline

Modules
15

Alarms
0

Scroll

Module
Shelf
Slot

Operating the ICIM, Continued

Prisma II ICIM Menu

To display the ICIM menu, press the **ICIM** key. The ICIM menu (shown below) appears. Press the **SEL** key to select the specific option.

Display	Description
Shelf Slot	Displays the location of the ICIM module.
Mfg Data	Displays manufacturing data about the ICIM.
Password	Allows you to enter, change, or disable a system password. See Using the ICIM Password earlier in this chapter.
Update Adr	If the Chassis ID number switch has been changed, you must highlight the Update Adr menu and press the SEL key for the ICIM to recognize the change.

ICIM	ICIM	ICIM
Shelf 0 Slot 15	Shelf 0 Slot 15	Shelf 0 Slot 15
Mfg Data	Mfg Data	Mfg Data
Password	Password	Password
Update Adr	Update Adr	Update Adr

Operating the ICIM, Continued

Prisma II MAIN Menu and ICIM Menu Structure

Pressing the **MAIN** key initiates the MAIN software menu. Pressing the **ICIM** key initiates the ICIM software menu. The MAIN and ICIM software structures are shown below.

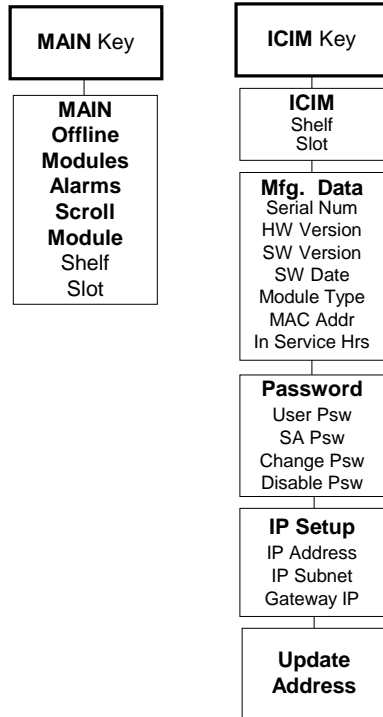

Operating the ICIM, Continued

Prisma II Optical Amplifier Software Menu Structure

From the MAIN or SCROLL menus, you can navigate to the MODULE menu. From the MODULE menu, press the **STAT**, **CFG**, or **ALRM** key to display the desired parameter menu. The structure for the Prisma II Optical Amplifier software is shown below.

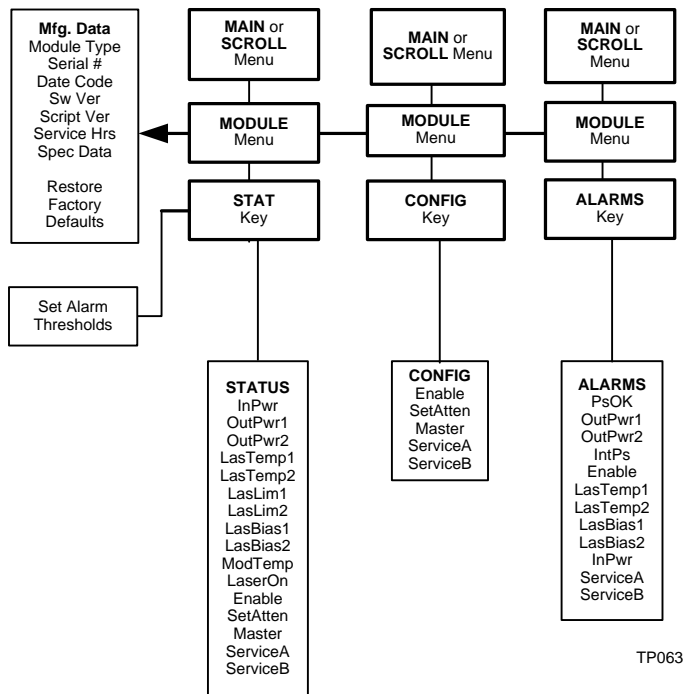

Monitoring Operating Status Using the ICIM

Checking Operating Status

Using the ICIM, you can check the status of all operating parameters of this module. All status information appears on the ICIM LCD.

Follow these steps to monitor operating parameters.

1. At the MAIN menu, press the key to highlight the **Shelf** and **Slot** fields.
2. Press the key to address the **Shelf** number. Then press the key or the key to scroll to the number of the desired shelf.
3. Press the key.

Result: The **Slot** field is highlighted.

4. Press the key or the key to scroll to the number of the desired slot.
5. Press the key.

Result: The **MODULE** menu appears on the ICIM.

6. Press the key.
7. Press the key or the key to scroll through the monitored parameters until you find the parameter of interest.
8. Check the status of the desired parameter or select other parameters to monitor. When finished, press the key to return to the **MAIN** menu.

Monitoring Operating Status Using the ICIM, Continued

STATUS Menus

Press the **STAT** key to select the **STATUS** menu. Some typical **STATUS** menus are shown below.

STATUS ----- Shelf 0 Slot 6 ----- Fttx Post - Amp ----- InPwr 4.85 dBm ----- OutPwr 22.5 dBm	STATUS ----- Shelf 0 Slot 6 ----- Fttx Post - Amp ----- LasTemp1 25.13 degC ----- LasLim1 0.805 A	STATUS ----- Shelf 0 Slot 6 ----- Fttx Post - Amp ----- LasBias1 0.213 A ----- TecCur1 0.345 A	STATUS ----- Shelf 0 Slot 6 ----- Fttx Post - Amp ----- ModTemp 25.13 degC ----- LaserOn 0.0 hrs
STATUS ----- Shelf 0 Slot 6 ----- Fttx Post - Amp ----- Enable ON ----- SetAtten 0 dB	STATUS ----- Shelf 0 Slot 6 ----- Fttx Post - Amp ----- Master ON		





Note: For additional information on operating status parameters, see **Appendix A, Module Parameter Descriptions**.

Configuring the Optical Amplifier Using the ICIM



Configuring Parameters

Using the ICIM, you can configure the parameters listed below. A list of configurable parameters and CONFIG menus follow these steps.







Follow these steps to configure parameters.

1. From the **MAIN** menu, press the  key to highlight the **Shelf** and **Slot** fields.
2. Press the  key to address the **Shelf** number. Then press the  key or the  key to scroll to the number of the desired shelf.
3. Press the  key.

Result: The **Slot** field is highlighted.

4. Press the  key or the  keys to scroll to the number of the desired slot.
5. Press the  key.

Result: The **MODULE** menu appears on the ICIM.

6. To configure the module, press the  key.
7. Press the  key or the  key to scroll through the configurable controls until you find the parameter of interest.
8. Press the  key to select the highlighted control.
9. Press the  key or the  key to activate or change the value of the selected control.
10. Press the  key to save the changes and return to the **MAIN** menu.

Configuring the Optical Amplifier Using the ICIM, Continued

CONFIG Menus

When the **CONFIG** menu is selected, the **Shelf** number field is highlighted. The shelf and slot number fields may only be incremented with the **+** key or the **-** key. The **▼** key highlights the **Slot** number field. Once you exit the slot field, the up/down arrows will scroll through the parameters that are specific to this module. Sample Prisma II Optical Amplifier **CONFIG** menus are shown below.

CONFIG	CONFIG	CONFIG	CONFIG
Shelf 0	Shelf 0	Shelf 0	Shelf 0
Slot 6	Slot 6	Slot 6	Slot 6
Fttx Post - Amp	Fttx Post - Amp	Fttx Post - Amp	Fttx Post - Amp
Enable SetAttn Master	Enable ON	SetAttn 0.0dB	Master ON

Note: For additional information on configurable parameters, see **Appendix A, Module Parameter Descriptions**.

Checking Optical Amplifier Alarms Using the ICIM

Checking Alarms

If the red ALARM LED on the front panel is blinking a minor alarm condition is indicated. If the red ALARM LED on the front panel is illuminated, a major alarm condition is indicated.

Alarms fall into one of the following categories.

- Major low
- Minor low
- Minor high
- Major high

Follow these steps to check alarm conditions.

1. From the MAIN menu, press the key to highlight the **Shelf** and **Slot** fields.
2. Press the key to address the **Shelf** number. Then press the key or the keys to scroll to the number of the desired shelf.
3. Press the key.
Result: The **Slot** field is highlighted.
4. Press the key or the key to Scroll to the number of the desired slot.
5. Press the key.
Result: The **MODULE** menu appears on the ICIM.
6. Press the key.
Result: Module alarm conditions appear.
7. Use the key or the key to scroll through alarm conditions until the desired alarm appears.
8. Monitor the alarm condition(s). Take appropriate action. Verify that all settings and thresholds relating to the alarm indication are set correctly to rule out an unintended alarm.
9. When finished, press the key to return to the MAIN menu.

Checking Optical Amplifier Alarms Using the ICIM, Continued

Adjustable Alarm Menus

When a module's **ALARM** menu is selected, press the key or the key to scroll through alarms. Typical adjustable alarms menus are shown below.

ALARMS	
Shelf	0
Slot	6

Fttx Post - Amp	

LasBias1 MinorH	

ALARMS	
Shelf	0
Slot	6

Fttx Post - Amp	

InPwr MajorH	

ALARMS	
Shelf	0
Slot	6

Fttx Post - Amp	

OutPwr MinorL	

Setting Adjustable Alarm Thresholds

Follow these steps to change an adjustable alarm threshold from the factory default.

1. At the MODULE menu, press the key.
Result: The STATUS menu appears on the ICIM.
2. Press the key. The alarm thresholds previously set appear. If the label **n/a** appears, you cannot configure that alarm threshold. Press the key to highlight the next parameter's alarm threshold.
3. When the threshold that you wish to set is highlighted, press the key.
4. Press the key or the key to change the increment size.
5. Press the key or the key to adjust the alarm threshold.
Note: Press Cancel () key to return to the previous menu.
6. Press the key to save the changes.
Result: **Data Saved** appears.
7. When finished, press the key to return to the MAIN menu.

Checking Optical Amplifier Alarms Using the ICIM, Continued

Optical Amplifier Alarm Threshold Menus

Some typical alarm threshold menus are shown below. Exact values are dependant on amplifier type and configuration.

STATUS	
Shelf	0
Slot	6

Fttx	
Post - Amp	

LasBias	
MajH	0.349
MinH	0.340
MinL	-1.650
MajL	-0.650

STATUS	
Shelf	0
Slot	6

Fttx	
Post - Amp	

OutPwr	
MajH	17.00
MinH	16.70
MinL	15.30
MajL	15.00

STATUS	
Shelf	0
Slot	6

Fttx	
Post - Amp	

InPwr	
MajH	50.00
MinH	25.70
MinL	0
MajL	-10.00

Note: For additional information on adjustable alarm parameters, see **Appendix A, Module Parameter Descriptions**.

Checking Optical Amplifier Alarms Using the ICIM, Continued

Non-Adjustable Alarm Menus

Non-adjustable alarms are set at the factory and cannot be adjusted by the user.

When a module's **ALARM** menu is selected, press the key or the key to scroll through alarms. Typical module **ALARM** menus are shown below.

ALARMS	ALARMS	ALARMS
Shelf 0	Shelf 0	Shelf 0
Slot 6	Slot 6	Slot 6
Fttx	Fttx	Fttx
Post-Amp	Post-Amp	Post-Amp
Enable FAULT	Lastemp MinorL	IntPs FAULT

Note: For additional information on non-adjustable alarm parameters, see **Appendix A, Module Parameter Descriptions**.

Checking Manufacturing Data Using the ICIM

Checking Manufacturing Data

The Manufacturing Data information listed later can be displayed on the ICIM menu. To access the module's Manufacturing Data, follow these steps.

1. From the MAIN menu, press the key to highlight the **Shelf** and **Slot** fields.
2. Press the key to address the **Shelf** number. Then press the key or the keys to Scroll to the number of the desired shelf.
3. Press the key.

Result: The **Slot** field is highlighted.

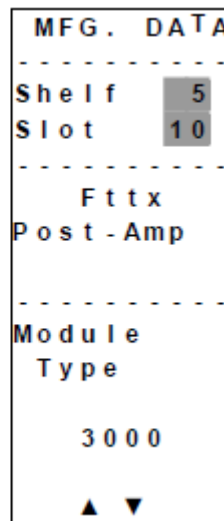
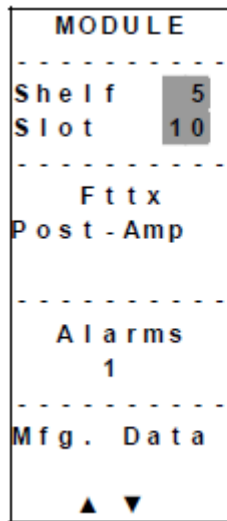

4. Press the key or the key to scroll to the number of the desired slot.
5. Press the key. The **MODULE** menu for this module will be selected, as shown on the left below. Press the key to enter the start of the manufacturing data menus, as shown on the right below.



6. The or keys allow you to scroll through the manufacturing data.

Checking Manufacturing Data Using the ICIM, Continued

MFG. DATA Menus

When the **MFG. DATA** menu is selected, the  key or the  key allows you to scroll through the manufacturing parameters specific to this module. Sample **MFG. DATA** menus are shown below. Data is dependant on transmitter type.

MFG. DATA	MFG. DATA	MFG. DATA	MFG. DATA
Shelf 5 Slot 12	Shelf 5 Slot 12	Shelf 5 Slot 12	Shelf 5 Slot 12
Fttx Post-Amp	Fttx Post-Amp	Fttx Post-Amp	Fttx Post-Amp
Module Type 3017	Serial # !ABCDEFG Date Code M00	Ver CC1.14 Script Ver 13	In Service Hours 1
▲ ▼	▲ ▼	▲ ▼	▲ ▼

Note: For additional information on manufacturing data parameters, see **Appendix A, Module Parameter Descriptions**.

Using the ICIM to Save the Configuration

Saving the Current Configuration

To save the current module configuration, follow these steps after every change.

1. After you have changed a parameter or entered data, press the **ENTER** key to save the changes and return to the MAIN menu.
2. If you do not save your changes for two minutes, or if you press the **SHIFT** **CAN** keys at the same time, changes are aborted and the display returns to the MAIN menu.

Configuration Complete

Once you have configured this module to your system's specifications using the ICIM and no alarms are indicated, no further action is necessary. The module operates without further input. Alarms, changes in operating parameters, electrical power fluctuations, or changes in system design may be cause for additional action.

SNMP Configuration Capability

Introduction

The IP Setup menu item in the ICIM menu allows you to enter an IP address, IP subnet, and Gateway IP in order to configure the ICIM for remote status monitoring and control by an SNMP network management system.

This section does not describe how to implement SNMP. Refer to your SNMP manager documentation and/or MIB information for instructions on implementing SNMP, Version 1.

All of this configuration is also available through the Boot Dialog. The Boot Dialog also allows community names and the default port number for traps to be changed.

Note: Contact Cisco Services for MIB files.

SNMP Considerations

The following items should be considered when implementing SNMP:

- The SNMP connection is made through the Ethernet port on the front of the ICIM. (Use 10baseT cable with an RJ-45 connector.) In order to meet the requirements of GR1089-CORE, a shielded cable must be used and both ends must be grounded.
- The Network Management System (NMS) must be installed behind a firewall to prevent any ill-intentioned persons with an SNMP manager from accessing, and tampering with, the ICIM.
- When the ICIM has to handle excessive SNMP traffic, it will respond slowly to both SNMP control and front panel input. If this occurs, reduce the update rate of the SNMP manager.

Important: If an HDRX chassis is set to chassis ID 41, the ICIM will not detect receiver 9 in that chassis.

Basic SNMP Setup

Refer to your SNMP manager documentation and/or Management Information Base (MIB) information for instructions on implementing SNMP. Before you can use and reconfigure SNMP services, you need to know the community names in your network and the IP addresses or computer names for SNMP management hosts to which traps are sent.

SNMP Configuration Capability, Continued

Setting Up the IP Configuration Parameters for SNMP Support

Follow these steps to set up the IP configuration parameters.

1. Press the key.

Result: The ICIM menu appears.

2. Select the **Password** menu and enter the User Password.

Result: The ICIM allows configuration changes for the next 10 minutes.

Note: Refer to your specific hardware Installation and Operation Guide for more information on using, entering, or changing the ICIM user password.

3. Press the key.

Result: The ICIM menu appears.

4. Use the key to scroll down until **IP Setup** is highlighted.

5. Press the key.

```
      I C I M
-----
S h e l f      7
S l o t      15
-----
I P A d d r e s s
172 . 18 . 9
. 227
I P S u b n e t
255 . 255
. 255 . 0
G a t e w a y I P
172 . 18 . 9
. 254
```

Result: The IP Setup menu appears, as shown above.

6. Use the or keys to scroll to and highlight the desired configuration parameter; IP Address, IP Subnet, or Gateway IP.

SNMP Configuration Capability, Continued

7. Press the **SEL** key.

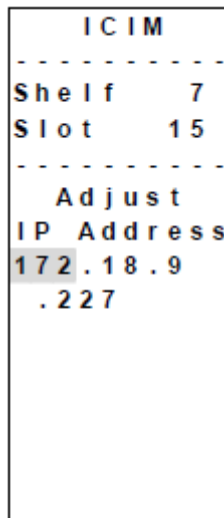

Result: The Adjust menu for the selected IP parameter appears and the first segment of the address is highlighted.

Note: The example above shows the IP Address parameter Adjust menu. The Adjust menus for IP Subnet and Gateway IP are similar.

8. Enter the correct numbers for the first segment of the address.

Notes: One of two methods can be used to enter the numbers, as follows:

- Press the **+** or **-** keys to increase/decrease the number to set value.
- Press the **SHIFT** key to change to the numeric entry mode. ("Numlock On" appears on the front panel LCD.) Then enter the exact number using the number keys on the 12-key numeric keypad.

9. Press the **ENTR** key to accept your entry and move to the next address segment to the right. (You can also use the **▼** or **▲** keys to move to the address segment of your choice.)

Note: If you are using the numeric entry mode, the cursor moves to the next address segment to the right automatically after you enter the last digit of the current address segment.

10. Repeat steps 8 and 9 until all address segments are entered.

Result: After you enter the last address segment and press the Enter key, the system returns to the IP Setup menu.

SNMP Configuration Capability, Continued

11. Repeat steps 6 through 10 for each IP Setup parameter that you need to enter.
12. Restart the ICIM.

Important: IP Setup parameters do not take effect until the ICIM is restarted.

Restarting the ICIM

Follow these steps to restart the ICIM.

1. Unscrew the captive screw near the top right-hand corner of the ICIM.
2. Unlock the top and bottom ejector levers near the left-hand side of the ICIM.
3. Pull the ejector levers out and away from the front panel to disconnect the ICIM from the chassis backplane connector.
4. Pull the ICIM at least 1.5 inches (3.81 cm) out from the front of the chassis to ensure that it is fully separated from the chassis backplane connector.
5. Reinsert the ICIM into the chassis until the ejector levers insert into their respective slots in the chassis.
6. Push the ejector levers in and flat against the ICIM front panel to reconnect the ICIM to the backplane connector until the ejector levers lock in place.
7. Screw in the captive screw to secure the ICIM in the chassis.

Community Names

Default Community Names

The community name provides primitive security and context checking for both agents and managers that request and initiate trap operations. An agent does not accept a request from a manager outside the community.

Community names that ICIM expects are:

Read Community	public
Read/Write Community	private
Trap Community	SNMP_trap

Note: These can be changed using the Boot Dialog (in **Boot Dialog for ICIM/SNMP Configuration** later in this chapter) along with the default port number for HMS traps.

Setting SNMP Trap Receiver Parameters

Introduction

Using the SNMP trap receiver parameters, you can specify up to five IP addresses that Cisco proprietary traps will be sent to. You can also specify what events will result in a trap being sent to the network management systems at these IP addresses. The Cold Start trap will always be sent to all network management systems. The Authentication Failure trap will also be sent to all trap receivers if the `snmpEnableAuthenTraps` is set to "Enabled."

You can specify which enterprise specific traps are sent to each trap receiver by setting variables in the P2TrapRecv table.

Set Traps in P2TrapRecvEntry

Entries to the P2TrapRecvEntry file can be made to send the trap information to a trap handler. The SNMP agent automatically sends an alert when the value of an object changes or exceeds a predefined threshold.

Follow these steps to set traps for a specific IP address.

1. On an SNMP manager, go to the P2TrapRecvEntry table.
2. Type the IP address that you want the trap sent.
3. Select **Enable** from the drop-down list.

Result: The new IP address is enabled and traps are sent to this IP address. Any changes are immediately stored to the EEPROM so the changes are not lost if power is lost or the ICIM is reset.

New SNMP Variables

Introduction

Supporting traps requires additional data available through SNMP. This additional data may be useful even if not using traps.

SNMP is the only way this additional data can be accessed. It cannot be accessed through the ICIM front panel or an SMC interface.

Table of Inserted Modules

This table is named p2InsertModuleTable. This table contains a list of modules that have been inserted since the last time the ICIM was reset or told to update the chassis ID for all modules. It does not include modules found when the initial search for modules is performed.

The modules appear in chronological order with the most recently inserted module always being in index position 1. If the number of modules inserted exceeds the capacity of the table, the oldest entries are deleted.

This table only contains the chassis and slot ID for a detected module. It is necessary to look at the other tables for more information.

Each row of this table is made up of the following variables:

p2InsertModuleIndex	The index for this table. The most recently inserted module is always in index position 1.
p2InsertModuleChassisID	The chassis ID number of the new module.
p2InsertModuleSlotID	The slot ID number of the new module.

Table of Removed Modules

This table is named p2RemoveModuleTable. This table contains a list of modules that have been removed since the last time the ICIM was reset or told to update the chassis ID for all modules.

The modules appear in chronological order with the most recently removed module always being in index position 1. If the number of modules removed exceeds the capacity of the table, the oldest entries are deleted.

New SNMP Variables, Continued

If a module is removed before the PNP data is read in the type, name and serial number is blank.

Each row of this table is made up of the following variables:

p2RemoveModuleIndex	The index for this table. The most recently removed module is always in index position 1.
p2RemoveModuleChassisID	The chassis ID number of the removed module.
p2RemoveModuleSlotID	The slot ID number of the removed module.
p2RemoveModuleName	The name of the removed module. This name is from the PNP data for this module and matches what the ICIM and SNMP display as the name. TNCS and LCI may use a different name.
p2RemoveModuleType	The TNCS type number of the removed module. This number uniquely identifies every type of module.
p2RemoveModuleSerialNum	The serial number of the removed module. This information is needed to determine if a module has been replaced with one that is the same type.

Previous IP Address

This variable is named p2PreviousIP. When the IP of the ICIM is changed using the front panel, this variable returns the previous ICIM IP address. It returns 0.0.0.0 until the IP address of the ICIM is changed for the first time.

Boot Dialog for ICIM/SNMP Configuration

Introduction

The boot dialog is presented whenever the ICIM is powered up (a cold boot). It is accessible via the LCI communications port on the front of the Prisma2 chassis.

Important: A null modem is required along with a terminal emulator program, such as the ubiquitous hyperTerm program on a Windows PC.

The serial port on the PC used by the terminal emulator program should be set up with these parameters:

- 9600 baud
- 8 data bit
- No parity bit
- 1 stop bit

This parameter is often displayed as: 9600 8-N-1

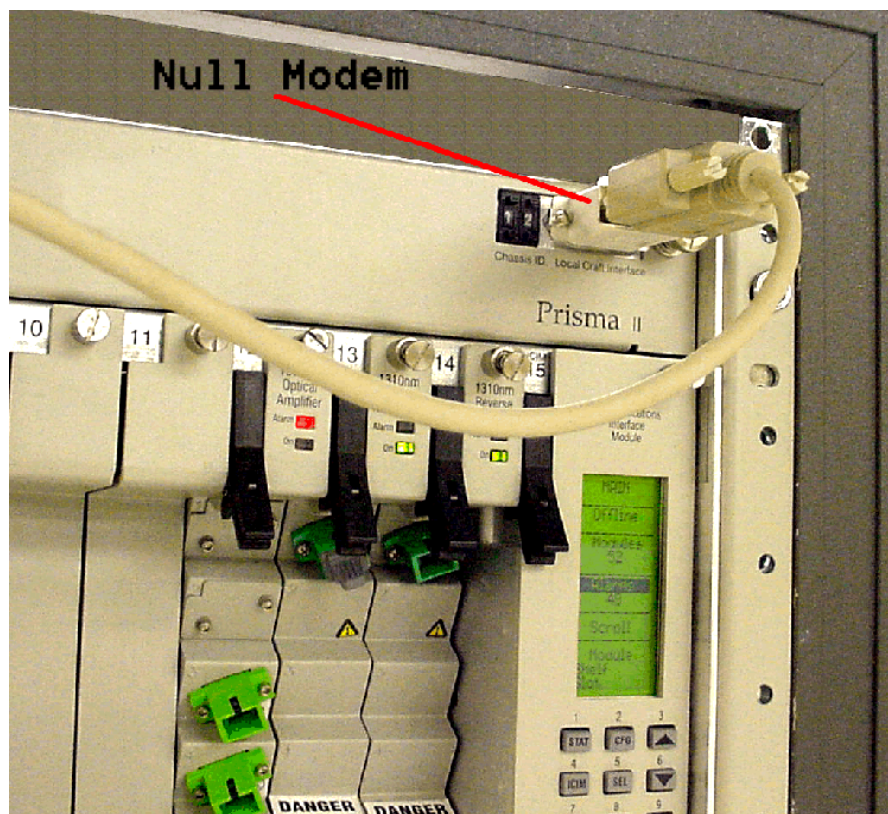

Boot Dialog for ICIM/SNMP Configuration, Continued

The boot dialog's primary use is to flash a new version of the ICIM application via a TFTP server.

Important: Do this only under the direction of Cisco Services.

During a flash operation, the low-level parameters can be changed, including community strings, port number for traps, IP address, etc.

The procedures below initially tells the ICIM that it is to be updated (flashed), whereupon it presents a configuration dialog, new values are entered and saved, then the ICIM is told to **not** update the program and proceed to normal ICIM operations.

Preparing to Change Parameters

Follow these steps to prepare to change parameters.

1. When the ICIM is powered up, it presents a summary screen along with a prompt to "...press any key within 5 seconds."

Result: The following screen appears.

```
Start-Up Configuration Dialog
Copyright (c) 2000 - 2004, Cisco Systems, Inc.
-----
START-UP MODE:
  Run ICIM Application
NETWORK INTERFACE PARAMETERS:
  IP address on LAN is 192.133.194.219
  LAN interface's subnet mask is 0xfffff00
SNMPv1 COMMUNITY:
  Read Community: public      Write Community: private
  Trap Community: SNMP_trap   Trap Port: 162
HARDWARE PARAMETERS:
  Serial channels will use a baud rate of 9600
  Board's Serial Number is ^AIIJHC
HARDWARE PARAMETERS:
  ICIM BSP Revision: ICIM Boot Rom, Rev: BT 0204 (02-23-2004)
  MPC860 (Rev 0.2) CPU running at 49 Mhz with 5 Mhz input clock
  ICIM Board with 16 Mbytes DRAM and 4 Mbytes App FLASH and 2 Mbytes
Boot FLASH
  This board's Ethernet hardware address is 0:2:DE:1:2:3
BOOT ROM PARAMETERS:
  IP address of the TFTP host is 192.133.194.4
  The file to download and start is ram.crc
  After board is reset, start-up code will wait 5 seconds
-----
To change any of this, press any key within 5 seconds
```

Note: During the first couple of seconds, the ICIM does not respond to a key press.

Boot Dialog for ICIM/SNMP Configuration, Continued

2. Press any key repeatedly until the following prompt appears.

Result:

```
(M)odify any of this or (C)ontinue? [M]
```

3. Press **Enter** to get the default value for Modify.

Result:

```
For each of the following questions, you can press <Return>
to select the value shown in braces, or you can enter a new
value.
```

```
How should the board boot?
```

1. pROBE+ (for debugging)
2. TFTP (for code download)
3. Run ICIM Application

```
Which one do you want? [3] 2
```

4. Select **2** for TFTP.

Note: We will **not** be doing a code download, but this gets access to the rest of the parameters dialog.

Boot Dialog for ICIM/SNMP Configuration, Continued

Changing Parameters

Below is an example dialog where one of the parameters (Trap Community) is changed. Any of the parameters can be changed, although some should be changed only with the advice of Cisco Services.

Note: Parameters that should **not** be changed are shown in blue.

```
NETWORK INTERFACE PARAMETERS:
Do you want a LAN interface? [Y]
This board's LAN IP address(0.0.0.0 = RARP)? [192.133.194.219]
Subnet mask for LAN (0 for none)? [255.255.255.0]
Should there be a default gateway for packet routing? [Y]
What is its IP address? [192.133.194.254]
SNMP COMMUNITY STRINGS:
Read Community [public]
Write Community [private]
Trap Community [SNMP_trap] ICIM_Trap
Trap Port for P2 traps [162]
HARDWARE PARAMETERS:
Baud rate for serial channels [9600]
Enter the Serial number? [^AAIIJHC]

HARDWARE PARAMETERS:
Do you want to change the board's Ethernet address? [N]
BOOT ROM PARAMETERS:
IP address of the TFTP Boot server to boot from? [192.133.194.4]
What is the name of the file to be loaded and started? [ram014.crc]
How long (in seconds) should CPU delay before starting up? [5]
```

Each time a prompt is given, the default value is displayed in square brackets.

1. Press **Enter** to retain the current value and move onto the next parameter.

Note: As an example in the above screen, the Trap Community string has been changed to a new value. The prompt for delay time is the last one before the summary screen is presented.

2. Press any key repeatedly until the following prompt appears.

Result:

```
(M)odify any of this or (C)ontinue? [M]
```

3. Press **Enter** to get the default value for Modify.

Boot Dialog for ICIM/SNMP Configuration, Continued

Restarting the ICIM

The boot selection dialog appears again.

```
For each of the following questions, you can press <Return> to
select the value shown in braces, or you can enter a new value.
```

```
How should the board boot?
```

1. pROBE+ (for debugging)
2. TFTP (for code download)
3. Run ICIM Application

```
Which one do you want? [2] 3
```

1. Select **3** to indicate that the normal ICIM application should be run (instead of TFTP).

Result: The summary page appears.

2. Do nothing and when the 5 second timeout expires, the ICIM restarts normally.

New Procedure for Adjusting Alarm Thresholds

Adjusting Alarm Thresholds

Relative alarm thresholds are both displayed and stored as a relative value. The new method for adjusting alarm thresholds allows the operator to choose any valid increment size and adjust the alarm threshold to any valid value.

Follow these steps to change an adjustable alarm threshold from the factory default.

1. At the MODULE menu, press the **STAT** key.
Result: The STATUS menu appears on the ICIM.
2. Press the **SEL** key. The alarm thresholds previously set appear. If the label **n/a** appear, you cannot configure that alarm threshold. Press the **▼** key to highlight the next parameter's alarm threshold.
3. When the threshold that you wish to set is highlighted, press the **ENTER** key.
4. Press the **▼** key or the **▲** key to change the increment size.
5. Press the **+** key or the **-** key to adjust the alarm threshold.
Note: Press the Cancel (**ALRM**) key to return to the previous menu.
6. Press the **ENTER** key to save the changes.
Result: **Data Saved** appears.
7. When finished, press the **MAIN** key to return to the MAIN menu.

Chapter 4

Operation Using LCI

Overview

Introduction

The installation steps and procedures in this chapter apply if you are using the Local Craft Interface (LCI) to operate the Prisma II Optical Amplifiers.

Scope of this Chapter

Included in this chapter are LCI installation instructions and detailed descriptions of how to use LCI to view and modify information for optical amplifiers.

In This Chapter

This chapter contains the following topics.

Topic	See Page
LCI Introduction	4-2
System Requirements	4-3
Installing LCI	4-4
Connecting Your Computer to the Chassis	4-7
Starting LCI	4-8
LCI Module Tree Overview	4-10
Accessing the Module Details Window	4-12
Checking the Operating Status	4-19
Configuring the Optical Amplifier	4-21
Checking Optical Amplifier Alarms	4-23
Modifying Optical Amplifier Alarm Limits	4-25
Checking Manufacturing Data	4-27



WARNING:

Avoid damage to your eyes! Do not look into any optical connector while the system is active. Even if the unit is off, there may still be hazardous optical levels present.

LCI Introduction

LCI Function

LCI is software that functions as a user interface for the Prisma II platform. LCI is installed on a computer, which is then connected to a Prisma II Chassis. Using LCI, you can configure and monitor the modules in the chassis the computer is connected to.

Important: Do not operate any Prisma II Chassis without a fan tray installed. If a fan tray is not installed in the Prisma II Chassis, the LCI will not communicate with the power supplies in that chassis.

System Requirements

Introduction

You will need the following computer software and hardware to run LCI.

Computer Requirements

- Pentium II 300 MHz processor or equivalent
- 128 MB RAM
- 10 MB available hard drive space
- 1.44 MB floppy drive
- CD-ROM Drive
- Windows 95 or later operating system software

Connecting the PC to the Prisma II Chassis

The required cable is a standard DB9 Female to DB9 Male serial extension cable. The connectors are a serial 9-pin D-shell (EIA 574/232).

The part number for a six-foot DB9 Female to DB9 Male extension cable is 180143.

Installing LCI

Introduction

This section describes how to install your LCI software.

Installing the LCI Software

Follow these steps to install the LCI software.

1. Close all programs that are running on your computer.
2. Insert the LCI CD-ROM into your CD-ROM drive.

Results:

- The LCI software installation program starts automatically. If the installation program does not start automatically, open Windows Explorer and double-click the file setup.exe on the LCI CD-ROM.
- The Welcome screen appears.

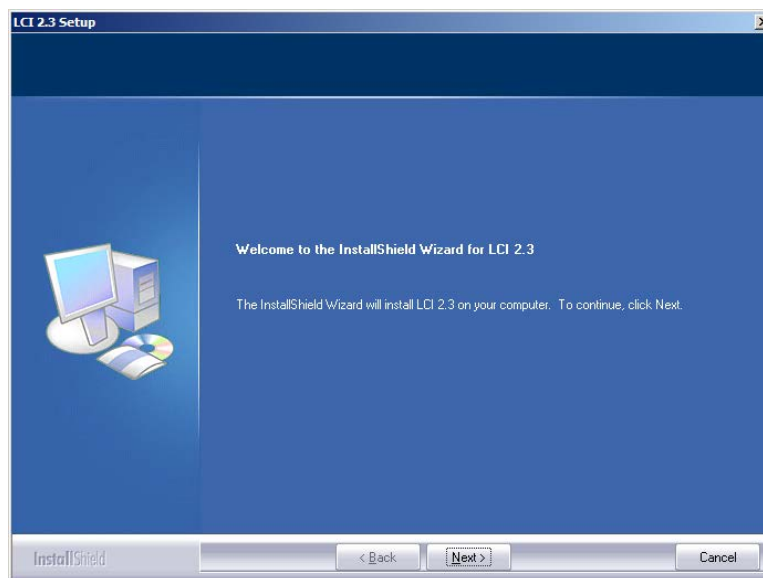

Installing LCI, Continued

3. Click Next.

Result: The Ready to Install screen appears.

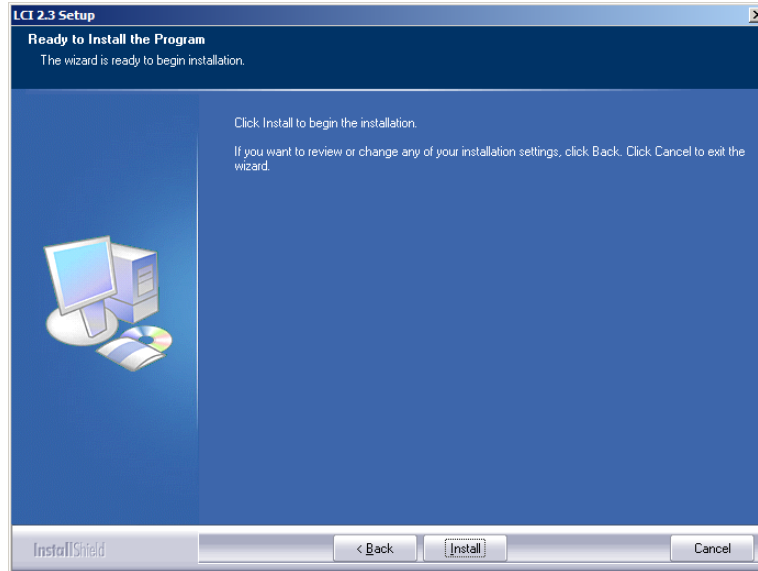

4. Click Install to begin installation.

Result: After a moment, the Setup Status screen appears displaying a progress indicator.

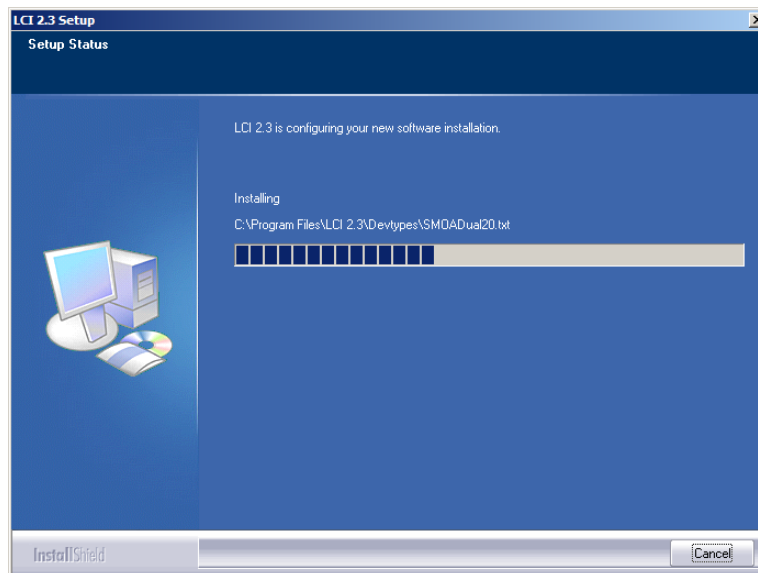

When finished, the InstallShield Wizard Complete screen appears.

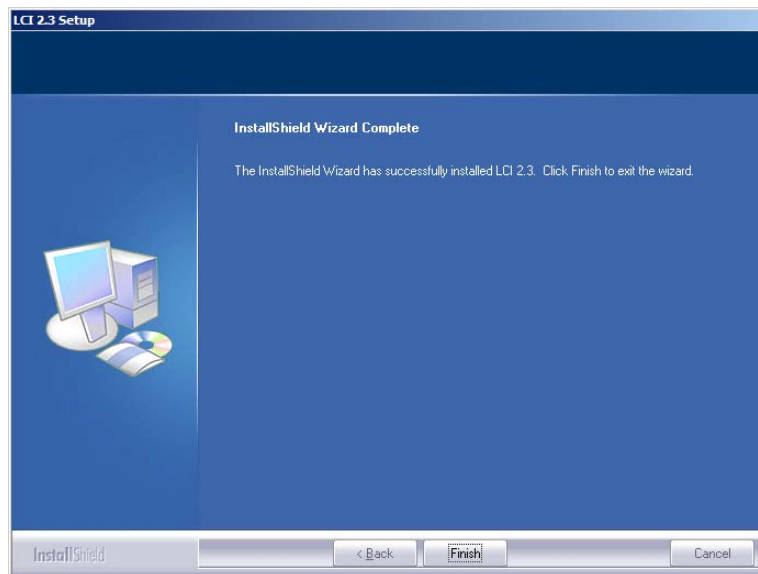

5. Click Finish to exit the install wizard.

Result: An LCI shortcut is placed on your Windows desktop.



The LCI software is now ready to use.

Connecting Your Computer to the Chassis

Introduction

Before you start LCI, you must first connect your computer to the chassis that contains the module(s) you want to check.

Important: LCI communicates only with those modules located in the chassis your computer is attached to. To check other modules, you must connect your computer to the chassis in which they are located.

Connecting to the Chassis

Follow these steps to connect your computer to the chassis.

1. Plug one end of a nine-pin RS-232 cable into your computer.
2. Plug the other end of the cable into the LCI port. This port is labeled “Local Craft Interface.”

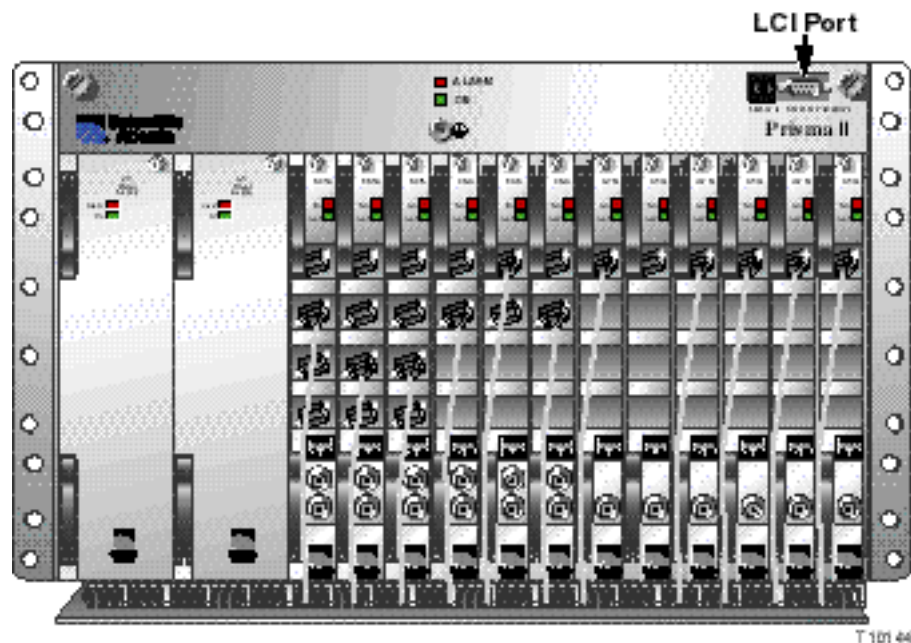

Starting LCI

Introduction

When LCI is started, it polls the module(s) located in the chassis your computer is attached to. For each module it finds, LCI does the following:

- Represents the module in the module tree of the main LCI window.
- Makes the polling information available so you can check and configure various parameters.

Important: Your computer must be connected to the chassis before you start LCI. For instructions, refer to **Connecting Your Laptop Computer to the Chassis** earlier in this chapter.

Starting LCI

Follow these steps to start the LCI software.

1. Double-click the LCI icon on your Windows desktop.



Result: The LCI Detect Configuration window appears.

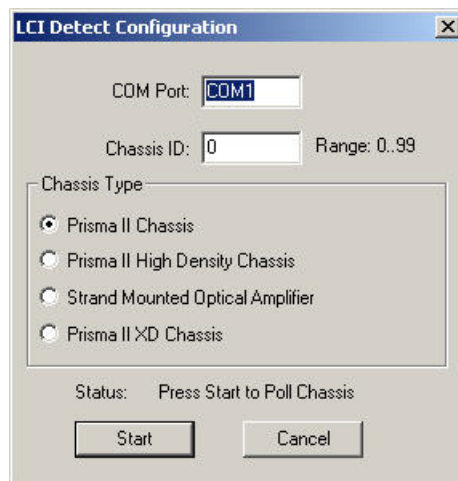

Starting LCI, Continued

- In the LCI Detect Configuration window, select the appropriate COM port, chassis ID, and chassis type, and then click **Start**.

Result: LCI polls the modules in the chassis. When finished, LCI displays a Refresh Complete message.

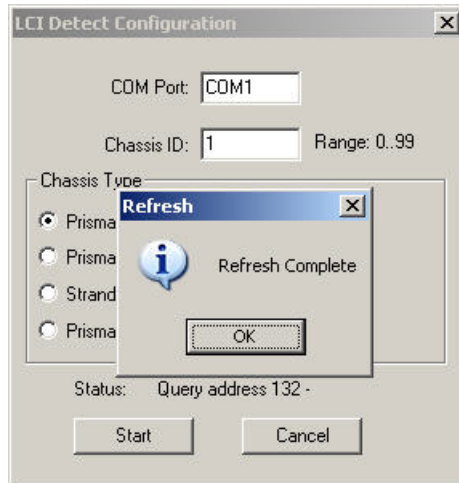

- Click **OK** to continue with LCI startup.

Result: The main LCI window appears.

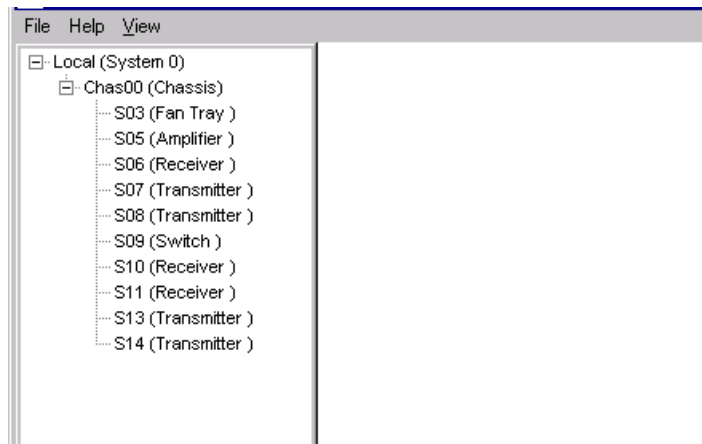

LCI Module Tree Overview

Introduction

The main window of LCI contains a tree that represents your system in a hierarchical manner.

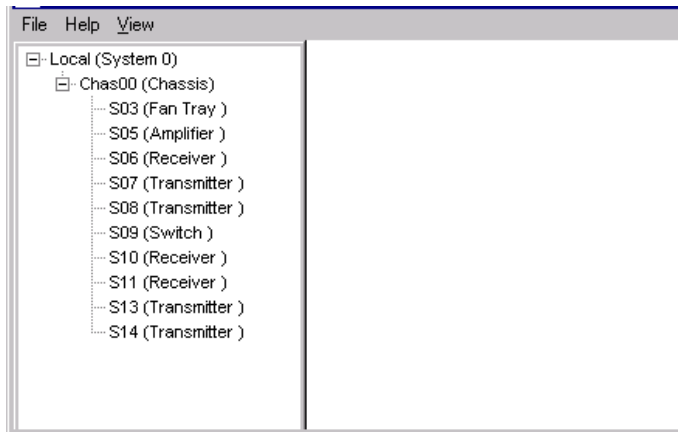

Module Tree

In the graphic above, the module tree represents a laptop connected to a chassis that contains ten modules. The three tree levels are described in the following table.

Module Tree Level	Description
Local (System 0)	Laptop computer being used
Chass00 (Chassis)	Chassis the computer is connected to
Sxx (Module name)	Module(s) located within the chassis. Each module is of the format <i>chassis slot location (module name)</i> . Example: In the graphic above, S05 (Amplifier) represents an optical amplifier located in slot 5 of the chassis.

LCI Module Tree Overview, Continued

Module Information

Information about a module (its parameters, alarms and statuses) is located in the Module Details window. Within the module tree, you can access this window using one of the following four methods:

- Double-click the chassis and select the module in the graphic that appears.
- Right-click the chassis and select **Open** from the menu that appears.
- Double-click the module.
- Right-click the module and select **Details** from the menu that appears.

Note: Although you can use the method that is most convenient for you, the procedures throughout this chapter are described using the right-click module technique.

For more information about each of these methods, refer to the next section, **Accessing the Module Details Window**.

Accessing the Module Details Window

Introduction

Information about a module (its parameters, alarms and statuses) is located in the Module Details window. The graphic below shows the Module Details window for a Prisma II Optical Post-Amplifier.

The screenshot shows the 'Optical Post-Amplifier' window with the following data:

Parameters							
	Present Value	Present Status	Nominal Value	Minor-Alarm Low-Limit	Minor-Alarm High-Limit	Major-Alarm Low-Limit	Major-Alarm High-Limit
Optical Input Power	21.2	Normal	21.0	-3.0	25.0	-6.0	45.0
Optical Output 1 Power	18.5	Normal	n/a	-0.7	0.7	-1.0	1.0
Optical Output 2 Power	18.5	Normal	n/a	-0.7	0.7	-1.0	1.0
Laser 1 Temperature	27.4	Normal	25.0	-15	35	-20	40
Laser 2 Temperature	28.1	Normal	25.0	-15	35	-20	40
Laser 1 Bias Current	5.11	Normal	6.70	n/a	-0.100	n/a	-0.010
Laser 2 Bias Current	4.63	Normal	6.70	n/a	-0.100	n/a	-0.010

<p>Alarms</p> <p>Summary Status Normal Communication Status Normal Power Supply Status Normal Internal Power Supply Status Normal Laser Enabled Status Normal Service Mode Ports A Status Normal Service Mode Ports B Status Normal</p>	<p>Controls</p> <p>Enable Laser On Optical Power Attenuation 0 dB Operational Mode Master Service Mode Ports A Off Service Mode Ports B Off</p>	<p>Properties</p> <p>Devtype Revision 1.00 Name S14</p> <p>Graphic</p> <p>Service Name Symbol Device Location Alias Notify Set A Notify Set B M&C Scan On_Scan Maintenance Mode Normal Poll Counter 1</p> <p>Script</p> <p>Comm Alarm Threshold 1 Comm Quality % Address 14 Port COM1 Generic Name FTTX Post Amplifier Description Optical Post-Amplifier Software Revision 1.13 Script Version 15 Serial Number ^AAFDAOP Time Of Service 58 Hrs Laser On Time 0 Hrs Day Code CD5 Module Type 3018</p>
<p>Status</p> <p>Laser 1 Limit 6.67 A Laser 2 Limit 6.69 A Module Temperature 29.3 deg-C</p>		

Within the LCI module tree, you can access this window using one of the following four methods:

- Double-click the chassis and select the module in the graphic that appears.
- Right-click the chassis and select **Open** from the menu that appears.
- Double-click the module.
- Right-click the module and select **Details** from the menu that appears.

Note: Although you can use the method that is most convenient for you, the procedures throughout this chapter are described using the right-click module technique.

For more information about the module tree, refer to **LCI Module Tree Overview** earlier in this chapter.

Accessing the Module Details Window, Continued

Double-Click the Chassis

To access the Module Details window, follow these steps.

1. Double-click the chassis.

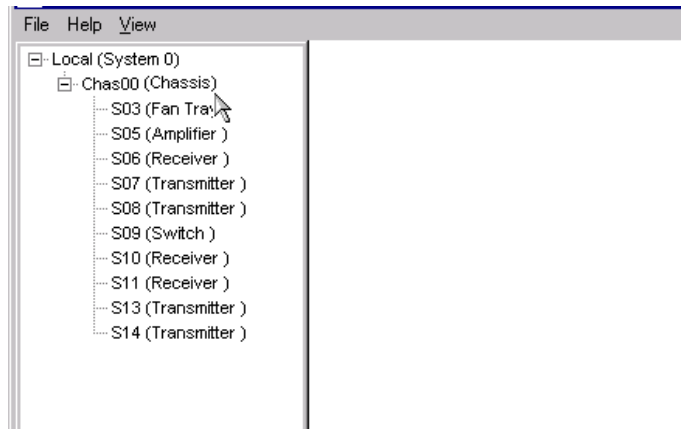

Result: A graphic representation of the chassis appears.

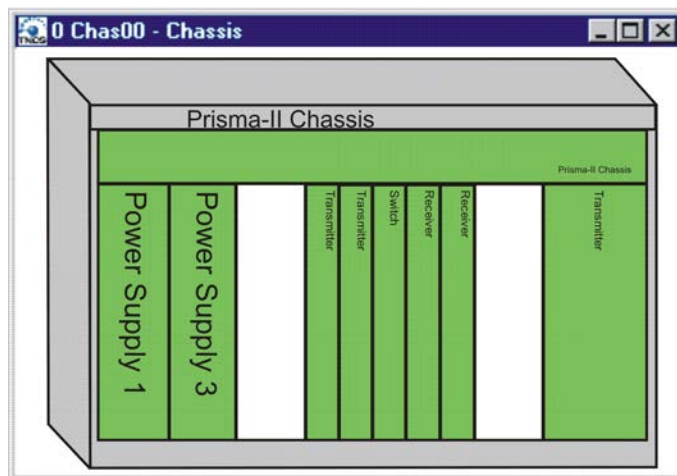

TP029

Accessing the Module Details Window, Continued

- Double-click the module whose information you want to view and/or configure.

Result: The Module Details window appears.

Optical Post-Amplifier

Parameters								
	Present Value	Present Status	Nominal Value	Minor Alarm Low-Limit	Minor Alarm High-Limit	Major Alarm Low-Limit	Major Alarm High-Limit	
Optical Input Power	21.2	Normal	21.0	-3.0	25.0	6.0	45.0	dBm
Optical Output 1 Power	18.5	Normal	n/a	-0.7	0.7	-1.0	1.0	dBm
Optical Output 2 Power	18.5	Normal	n/a	-0.7	0.7	-1.0	1.0	dBm
Laser 1 Temperature	27.4	Normal	25.0	-15	35	-20	40	deg-C
Laser 2 Temperature	28.1	Normal	25.0	-15	35	-20	40	deg-C
Laser 1 Bias Current	5.11	Normal	6.70	n/a	-0.100	n/a	-0.010	A
Laser 2 Bias Current	4.63	Normal	6.70	n/a	-0.100	n/a	-0.010	A

Alarms

Summary Status Normal
 Communication Status Normal
 Power Supply Status Normal
 Internal Power Supply Status Normal
 Laser Enabled Status Normal
 Service Mode Ports A Status Normal
 Service Mode Ports B Status Normal

Status

Laser 1 Limit 6.67 A
 Laser 2 Limit 6.69 A
 Module Temperature 29.3 deg-C

Controls

Enable Laser On
 Optical Power Attenuation 0 dB
 Operational Mode Master
 Service Mode Ports A Off
 Service Mode Ports B Off

Properties

Devtype Revision 1.00
 Name S14
 Graphic
 Service Name
 Symbol
 Device Location
 Alias
 Notify Set A
 Notify Set B
 M&C Scan On-Scan
 Maintenance Mode Normal
 Poll Counter 1
 Script
 Comm Alarm Threshold 1
 Comm Quality %
 Address 14
 Port COM1
 Generic Name FTTX Post Amplifier
 Description Optical Post-Amplifier
 Software Revision 1.13
 Script Version 15
 Serial Number ^AAFDAOP
 Time Of Service 58 Hrs
 Laser On Time 0 Hrs
 Day Code C05
 Module Type 301B

- Proceed with viewing and/or configuring information.

Accessing the Module Details Window, Continued

Right-Click the Chassis

To access the Module Details window, perform these steps.

1. Right-click the chassis, and then click **Open**.

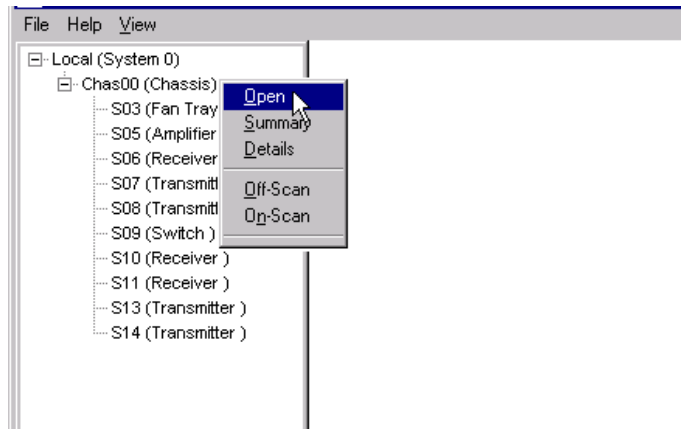

Result: A graphic representation of the chassis appears.

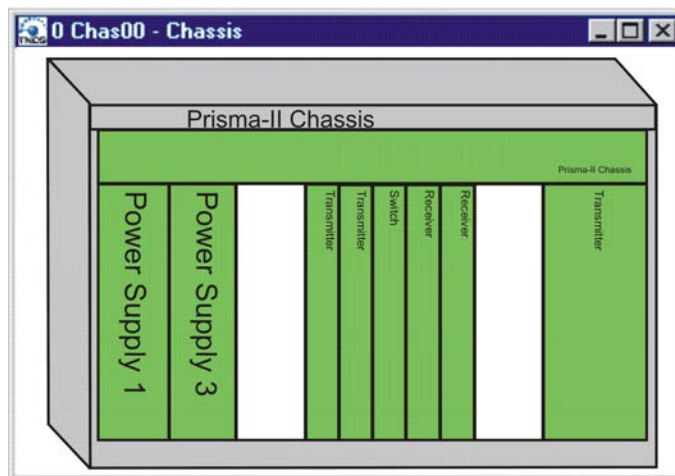

TP029

Accessing the Module Details Window, Continued

- Double-click the module whose information you want to view and/or configure.

Result: The Module Details window appears.

Optical Post-Amplifier

	Parameters							
	Present Value	Present Status	Nominal Value	Minor Alarm Low-Limit	Minor Alarm High-Limit	Major Alarm Low-Limit		Major Alarm High-Limit
Optical Input Power	21.2	Normal	21.0	-3.0	25.0	6.0	45.0	dBm
Optical Output 1 Power	18.5	Normal	n/a	-0.7	0.7	-1.0	1.0	dBm
Optical Output 2 Power	18.5	Normal	n/a	-0.7	0.7	-1.0	1.0	dBm
Laser 1 Temperature	27.4	Normal	25.0	-15	35	-20	40	deg-C
Laser 2 Temperature	28.1	Normal	25.0	-15	35	-20	40	deg-C
Laser 1 Bias Current	5.11	Normal	6.70	n/a	0.100	n/a	0.010	A
Laser 2 Bias Current	4.63	Normal	6.70	n/a	0.100	n/a	0.010	A

Alarms

- Summary Status: Normal
- Communication Status: Normal
- Power Supply Status: Normal
- Internal Power Supply Status: Normal
- Laser Enabled Status: Normal
- Service Mode Ports A Status: Normal
- Service Mode Ports B Status: Normal

Controls

- Enable Laser: On
- Optical Power Attenuation: 0 dB
- Operational Mode: Master
- Service Mode Ports A: Off
- Service Mode Ports B: Off

Properties

- Devtype Revision: 1.00
- Name: S14
- Graphic
- Service Name
- Symbol
- Device Location
- Alias
- Notify Set A
- Notify Set B
- M&C-Scan: On-Scan
- Maintenance Mode: Normal
- Poll Counter: 1
- Script
- Comm Alarm Threshold: 1
- Comm Quality: %
- Address: 14
- Port: COM1
- Generic Name: FTX Post Amplifier
- Description: Optical Post-Amplifier
- Software Revision: 1.13
- Script Version: 15
- Serial Number: *AAFDAOP
- Time Of Service: 58 Hrs
- Laser On Time: 0 Hrs
- Day Code: C05
- Module Type: 3018

Status

- Laser 1 Limit: 6.67 A
- Laser 2 Limit: 6.69 A
- Module Temperature: 29.3 deg-C

- Proceed with viewing and/or configuring information.

Accessing the Module Details Window, Continued

Double-Click the Module

To access the Module Details window, perform these steps.

1. Double-click the module.

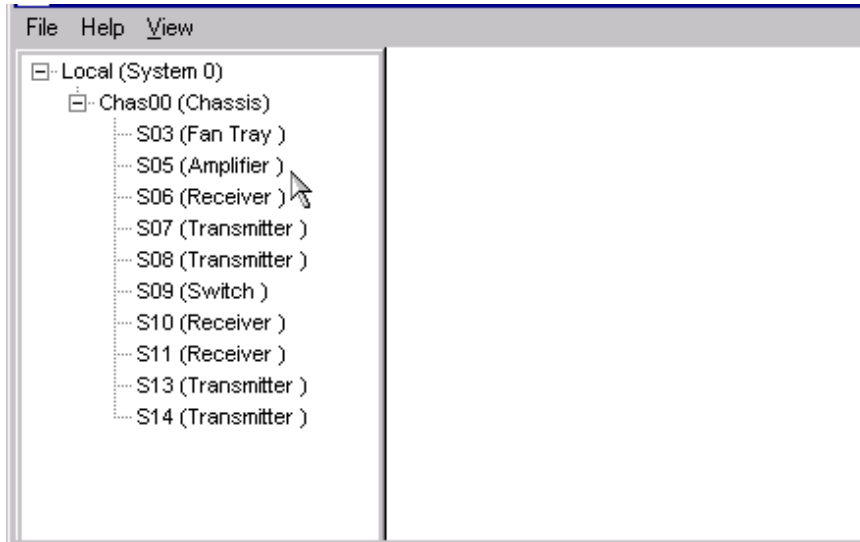

Result: The Module Details window appears.

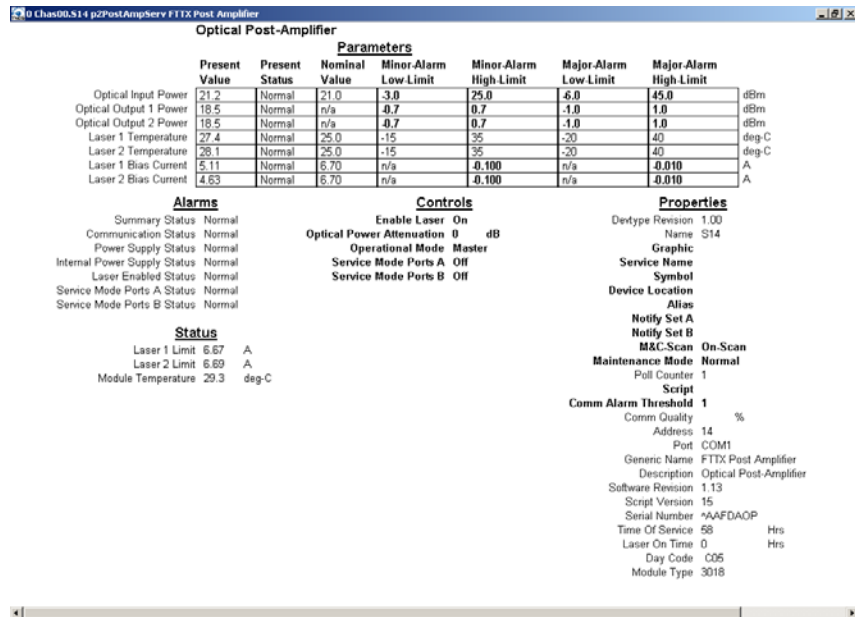

2. Proceed with viewing and/or configuring information.

Accessing the Module Details Window, Continued

Right-Click the Module

To access the Module Details window, perform these steps.

1. Right-click the module, and click **Details**.

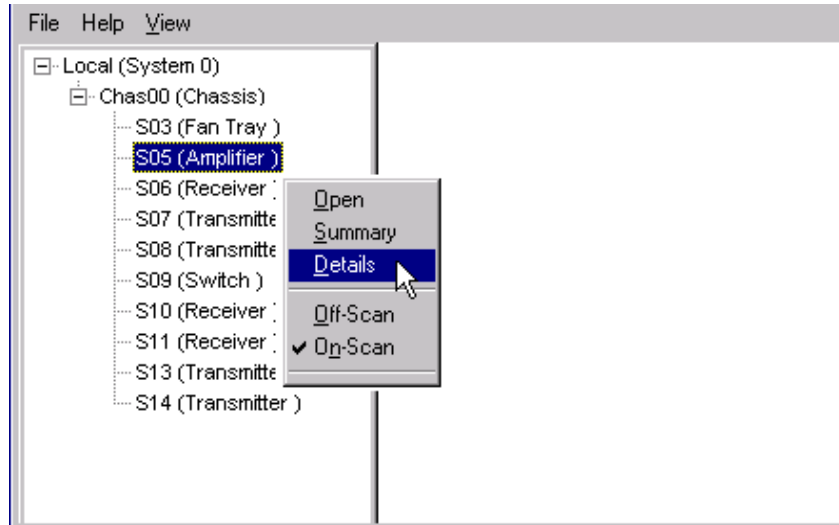

Result: The Module Details window appears.

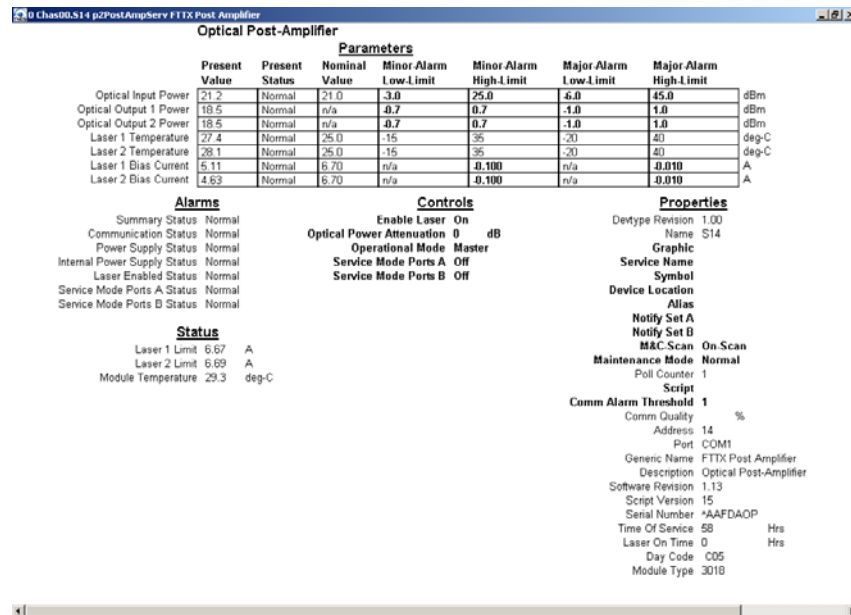

2. Proceed with viewing and/or configuring information.

Checking the Operating Status

Introduction

Using LCI, you can check the status of all operating parameters of the optical amplifiers.

Note: Not all parameters pertain to every optical amplifier. However, some optical amplifiers have multiple lasers and have multiple laser temperatures, limits, bias, etc. These multiples are designated in numeric order. For example, Laser Bias Current 1, Laser Bias Current 2, Laser Bias Current 3; Laser Temperature 1, Laser Temperature 2, Laser Temperature 3, etc.

Checking the Operating Status

To monitor the optical amplifier operating parameters, follow these steps.

1. In the module tree, right-click the Prisma II Optical Amplifier, and then click **Details**.

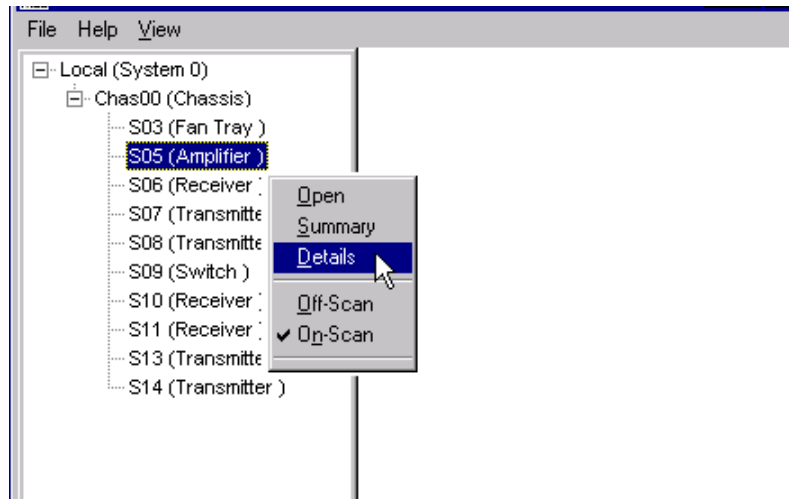

Checking the Operating Status, Continued

Result: The Module Details window appears. The monitored parameters are displayed under **Parameters** and **Status**.

Optical Post-Amplifier							
Parameters							
Present Value	Present Status	Nominal Value	Minor Alarm Low Limit	Minor Alarm High Limit	Major Alarm Low Limit	Major Alarm High Limit	
Optical Input Power	21.2	Normal	21.0	-3.0	25.0	45.0	dBm
Optical Output 1 Power	18.5	Normal	n/a	0.7	0.7	1.0	dBm
Optical Output 2 Power	18.5	Normal	n/a	0.7	0.7	1.0	dBm
Laser 1 Temperature	27.4	Normal	25.0	-15	35	40	deg-C
Laser 2 Temperature	28.1	Normal	25.0	-15	35	40	deg-C
Laser 1 Bias Current	5.11	Normal	6.70	n/a	0.100	n/a	A
Laser 2 Bias Current	4.63	Normal	6.70	n/a	0.100	0.010	A

Alarms	Controls	Properties
Summary Status: Normal	Enable Laser: On	Devtype Revision: 1.00
Communication Status: Normal	Optical Power Attenuation: 0 dB	Name: S14
Power Supply Status: Normal	Operational Mode: Master	Graphic:
Internal Power Supply Status: Normal	Service Mode Ports A: Off	Service Name:
Laser Enabled Status: Normal	Service Mode Ports B: Off	Symbol:
Service Mode Ports A Status: Normal		Device Location:
Service Mode Ports B Status: Normal		Alias:
		Notify Set A:
		Notify Set B:
		M&C Scan: On Scan
		Maintenance Mode: Normal
		Poll Counter: 1
		Script:
		Comm Alarm Threshold: 1
		Comm Quality: %
		Address: 14
		Port: COM1
		Generic Name: FTX Post Amplifier
		Description: Optical Post-Amplifier
		Software Revision: 1.13
		Script Version: 15
		Serial Number: *AAFDAOP
		Time Of Service: 58 Hrs
		Laser On Time: 0 Hrs
		Day Code: C05
		Module Type: 3010

- Proceed with checking the operating parameters.

Note: For additional information on operating status parameters, see **Appendix A, Module Parameter Descriptions**.

Configuring the Optical Amplifier

Introduction

Using LCI, you can configure the parameters listed below.

Configuring Parameters

To configure the parameters, follow these steps.

1. In the module tree, right-click the Prisma II Optical Amplifier, and then click **Details**.

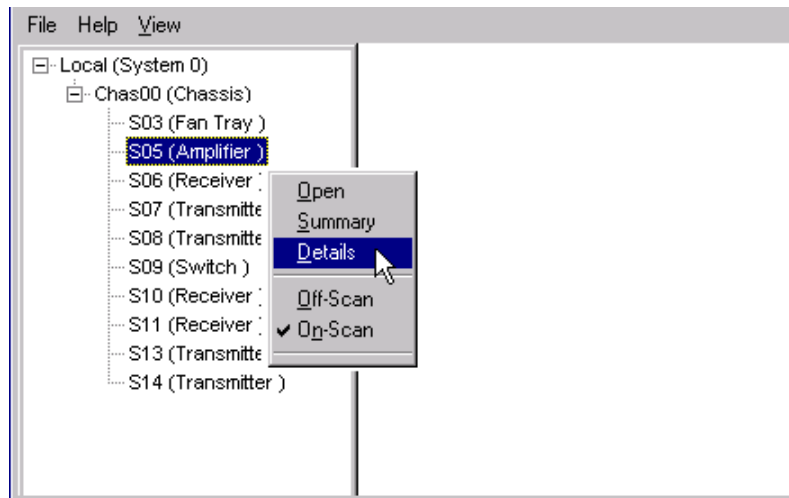

Result: The Module Details window appears.

Optical Post-Amplifier

		Parameters						
	Present Value	Present Status	Nominal Value	Minor Alarm Low Limit	Minor Alarm High Limit	Major Alarm Low Limit	Major Alarm High Limit	
Optical Input Power	21.2	Normal	21.0	3.0	25.0	4.0	45.0	dBm
Optical Output 1 Power	18.5	Normal	n/a	-0.7	0.7	-1.0	1.0	dBm
Optical Output 2 Power	18.5	Normal	n/a	-0.7	0.7	-1.0	1.0	dBm
Laser 1 Temperature	27.4	Normal	25.0	-15	35	-20	40	deg-C
Laser 2 Temperature	28.1	Normal	25.0	-15	35	-20	40	deg-C
Laser 1 Bias Current	5.11	Normal	6.70	n/a	0.100	n/a	0.010	A
Laser 2 Bias Current	4.63	Normal	6.70	n/a	0.100	n/a	0.010	A

<p>Alarms</p> <p>Summary Status Normal</p> <p>Communication Status Normal</p> <p>Power Supply Status Normal</p> <p>Internal Power Supply Status Normal</p> <p>Laser Enabled Status Normal</p> <p>Service Mode Ports A Status Normal</p> <p>Service Mode Ports B Status Normal</p>	<p>Controls</p> <p>Enable Laser On</p> <p>Optical Power Attenuation 0 dB</p> <p>Operational Mode Master</p> <p>Service Mode Ports A Off</p> <p>Service Mode Ports B Off</p>	<p>Properties</p> <p>Devtype Revision 1.00</p> <p>Name S14</p> <p>Graphic</p> <p>Service Name</p> <p>Symbol</p> <p>Device Location</p> <p>Alias</p> <p>Notify Set A</p> <p>Notify Set B</p> <p>M&C-Scan On Scan</p> <p>Maintenance Mode Normal</p> <p>Poll Counter 1</p> <p>Script</p> <p>Comm Alarm Threshold 1</p> <p>Comm Quality %</p> <p>Address 14</p> <p>Port COM1</p> <p>Generic Name FTX Post Amplifier</p> <p>Description Optical Post-Amplifier</p> <p>Software Revision 1.13</p> <p>Script Version 15</p> <p>Serial Number *AAFDAOP</p> <p>Time Of Service 58 Hrs</p> <p>Laser On Time 0 Hrs</p> <p>Day Code 005</p> <p>Module Type 3018</p>
--	--	---

Configuring the Optical Amplifier, Continued

2. Under **Controls**, double-click the parameter you want to configure.

Result: The Change Value dialog box appears. The graphic below shows the dialog box for the Enable Laser parameter.

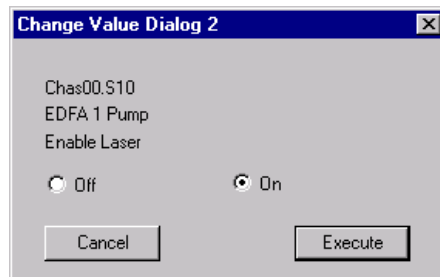

3. Depending on the parameter you chose, select or type a new value.
4. Click **Execute**.

Result: The new value appears next to the parameter.

Note: For additional information on configurable parameters, see **Appendix A, Module Parameter Descriptions**.

Checking Optical Amplifier Alarms

Introduction

Using LCI, you can check the alarm status of various parameters.

Alarms limits fall into one of the following categories.

- Major low
- Minor low
- Minor high
- Major high

Checking Alarms

To check a parameter's alarm status, perform these steps.

1. Right-click the Prisma II Optical Amplifier, and then click **Details**.

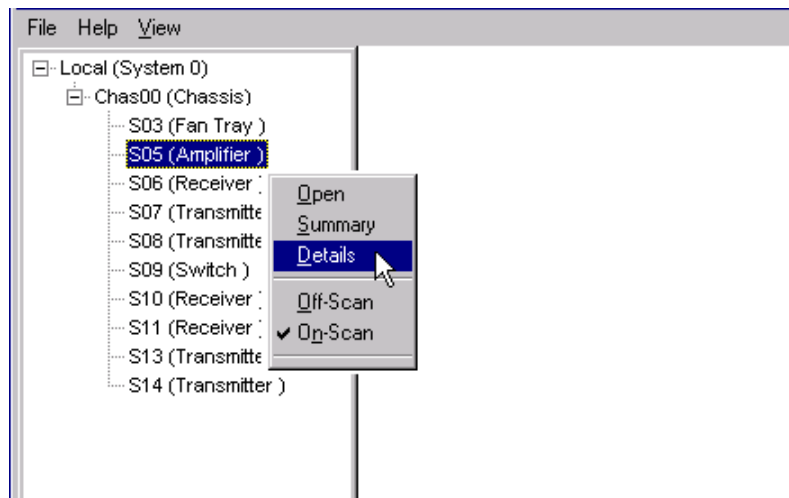

Result: The Module Details window appears. The alarms are shown under **Parameters** and **Alarms**.

Checking Optical Amplifier Alarms, Continued

Optical Post-Amplifier

Parameters								
Present Value	Present Status	Nominal Value	Minor Alarm Low-Limit	Minor Alarm High-Limit	Major Alarm Low-Limit	Major Alarm High-Limit		
Optical Input Power	21.2	Normal	21.0	3.0	25.0	6.0	45.0	dBm
Optical Output 1 Power	18.5	Normal	n/a	0.7	6.7	1.0	1.0	dBm
Optical Output 2 Power	18.5	Normal	n/a	0.7	6.7	1.0	1.0	dBm
Laser 1 Temperature	27.4	Normal	25.0	-15	35	-20	40	deg-C
Laser 2 Temperature	28.1	Normal	25.0	-15	35	-20	40	deg-C
Laser 1 Bias Current	5.11	Normal	6.70	n/a	0.100	n/a	0.010	A
Laser 2 Bias Current	4.63	Normal	6.70	n/a	0.100	n/a	0.010	A

Alarms	Controls	Properties
Summary Status Normal	Enable Laser On	Devtype Revision 1.00
Communication Status Normal	Optical Power Attenuation 0 dB	Name S14
Power Supply Status Normal	Operational Mode Master	Graphic
Internal Power Supply Status Normal	Service Mode Ports A Off	Service Name
Laser Enabled Status Normal	Service Mode Ports B Off	Symbol
Service Mode Ports A Status Normal		Device Location
Service Mode Ports B Status Normal		Alias
		Notify Set A
		Notify Set B
		M&C Scan On Scan
Status		Maintenance Mode Normal
Laser 1 Limit 6.67 A		Poll Counter 1
Laser 2 Limit 6.69 A		Script
Module Temperature 29.3 deg-C		Comm Alarm Threshold 1 %
		Address 14
		Port COM1
		Generic Name FTX Post Amplifier
		Description Optical Post-Amplifier
		Software Revision 1.13
		Script Version 15
		Serial Number *AAFDAOP
		Time Of Service 50 Hrs
		Laser On Time 0 Hrs
		Day Code C05
		Module Type 3010

- If any of the parameters are in alarm, take the corrective action you deem necessary.

Note: For additional information on alarm parameters, see **Appendix A, Module Parameter Descriptions**.

Modifying Optical Amplifier Alarm Limits

Introduction

Using LCI, you can modify alarm limits for several parameters. Alarm limits are dependant on module type and configuration.

Modifying Alarm Limits

To modify a parameter's alarm limit, follow these steps.

1. In the module tree, right-click the Prisma II Optical Amplifier, and then click **Details**.

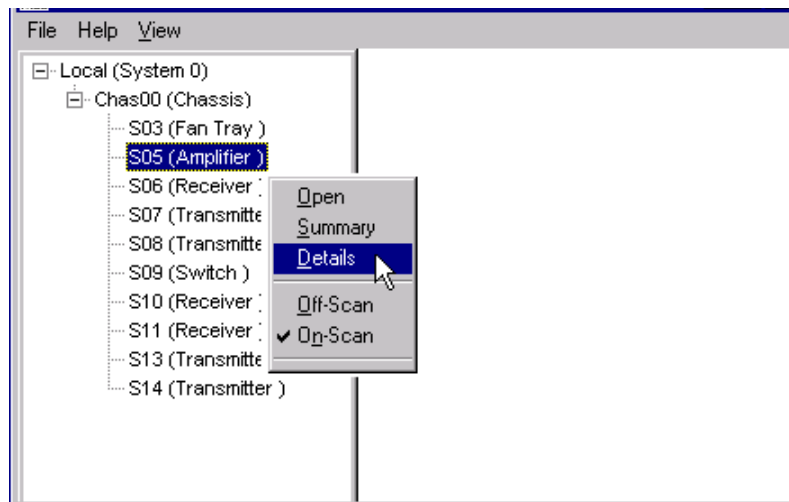

Result: The Module Details window appears. The alarm limits are shown under **Parameters**.

Modifying Optical Amplifier Alarm Limits, Continued

Optical Post-Amplifier Parameters

	Present Value	Present Status	Nominal Value	Minor Alarm Low Limit	Minor Alarm High Limit	Major Alarm Low Limit	Major Alarm High Limit	
Optical Input Power	21.2	Normal	21.0	3.0	25.0	6.0	45.0	dBm
Optical Output 1 Power	18.5	Normal	n/a	0.7	6.7	1.0	1.0	dBm
Optical Output 2 Power	18.5	Normal	n/a	0.7	6.7	1.0	1.0	dBm
Laser 1 Temperature	27.4	Normal	25.0	-15	35	-20	40	deg-C
Laser 2 Temperature	28.1	Normal	25.0	-15	35	-20	40	deg-C
Laser 1 Bias Current	5.11	Normal	6.70	n/a	0.100	n/a	0.010	A
Laser 2 Bias Current	4.63	Normal	6.70	n/a	0.100	n/a	0.010	A

Alarms

- Summary Status: Normal
- Communication Status: Normal
- Power Supply Status: Normal
- Internal Power Supply Status: Normal
- Laser Enabled Status: Normal
- Service Mode Ports A Status: Normal
- Service Mode Ports B Status: Normal

Status

- Laser 1 Limit: 6.67 A
- Laser 2 Limit: 6.69 A
- Module Temperature: 29.3 deg-C

Controls

- Enable Laser: On
- Optical Power Attenuation: 0 dB
- Operational Mode: Master
- Service Mode Ports A: Off
- Service Mode Ports B: Off

Properties

- Devtype Revision: 1.00
- Name: S14
- Graphic
- Service Name
- Symbol
- Device Location
- Alias
- Notify Set A
- Notify Set B
- M&C Scan: On Scan
- Maintenance Mode: Normal
- Pull Counter: 1
- Script
- Comm Alarm Threshold: 1 %
- Comm Quality: 14 %
- Address: 14
- Port: COM1
- Generic Name: FTX Post Amplifier
- Description: Optical Post-Amplifier
- Software Revision: 1.13
- Script Version: 15
- Serial Number: *AAFDAOP
- Time Of Service: 59 Hrs
- Laser On Time: 0 Hrs
- Day Code: C05
- Module Type: 3010

- Double-click the limit you want to change.

Result: The Change Value dialog box appears. The graphic below shows the dialog box for the major low limit of the Output Power parameter.

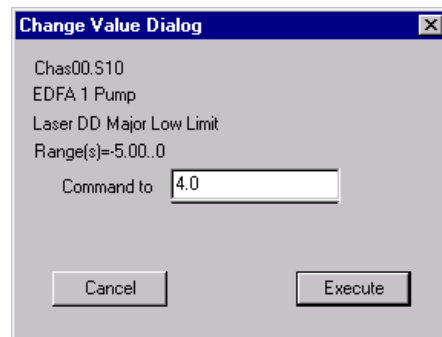

- In the **Command to** box, type the value to use for the limit.
- Click **Execute**.

Result: The new value appears in the alarm limit column.

Note: For additional information on alarm parameters, see **Appendix A, Module Parameter Descriptions**.

Checking Manufacturing Data

Introduction

Using LCI, you can check the manufacturing data of the Prisma II Optical Amplifier.

Manufacturing data is dependant on module type and configuration.

Checking Manufacturing Data

To access the module's manufacturing data, perform these steps.

1. In the module tree, right-click the Prisma II Optical Amplifier, and then click **Details**.

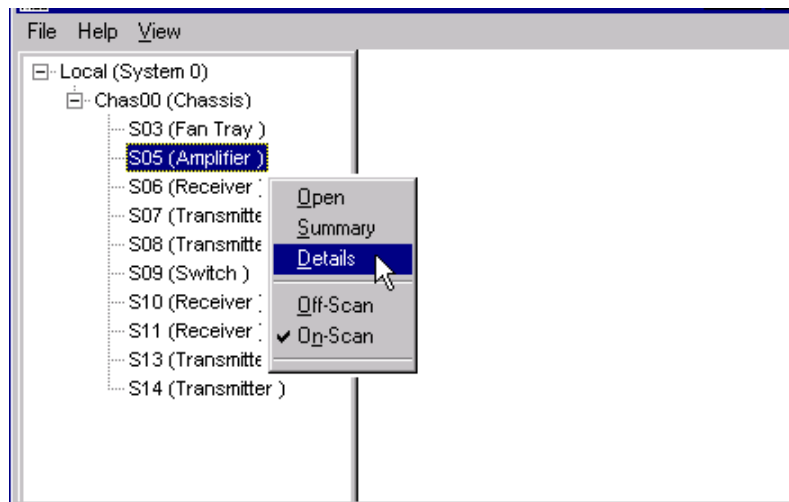

Result: The Module Details window appears. The manufacturing data is displayed under **Properties**.

Checking Manufacturing Data, Continued

Optical Post-Amplifier

Parameters								
Present Value	Present Status	Nominal Value	Minor Alarm Low Limit	Minor Alarm High Limit	Major Alarm Low Limit	Major Alarm High Limit		
Optical Input Power	21.2	Normal	21.0	3.0	25.0	6.0	45.0	dBm
Optical Output 1 Power	18.5	Normal	n/a	0.7	0.7	-1.0	1.0	dBm
Optical Output 2 Power	19.5	Normal	n/a	0.7	0.7	-1.0	1.0	dBm
Laser 1 Temperature	27.4	Normal	25.0	-15	35	-20	40	deg-C
Laser 2 Temperature	28.1	Normal	25.0	-15	35	-20	40	deg-C
Laser 1 Bias Current	5.11	Normal	6.70	n/a	0.100	n/a	0.010	A
Laser 2 Bias Current	4.63	Normal	6.70	n/a	0.100	n/a	0.010	A

Alarms	Controls	Properties
Summary Status Normal	Enable Laser On	Devtype Revision 1.00
Communication Status Normal	Optical Power Attenuation 0 dB	Name S14
Power Supply Status Normal	Operational Mode Master	Graphic
Internal Power Supply Status Normal	Service Mode Ports A Off	Service Name
Laser Enabled Status Normal	Service Mode Ports B Off	Symbol
Service Mode Ports A Status Normal		Device Location
Service Mode Ports B Status Normal		Alias
		Notify Set A
		Notify Set B
		M&C Scan On Scan
		Maintenance Mode Normal
		Poll Counter 1
		Script
		Comm Alarm Threshold 1
		Comm Quality %
		Address 14
		Port COM1
		Generic Name FTIX Post Amplifier
		Description Optical Post-Amplifier
		Software Revision 1.13
		Script Version 15
		Serial Number *AAFDAOP
		Time Of Service 50 Hrs
		Laser On Time 0 Hrs
		Day Code C05
		Module Type 3018

Status
Laser 1 Limit 6.67 A
Laser 2 Limit 6.69 A
Module Temperature 29.3 deg-C

- Proceed with viewing the manufacturing data.

Note: For additional information on manufacturing data parameters, see **Appendix A, Module Parameter Descriptions**.

Chapter 5

Maintenance and Troubleshooting

Overview

Introduction

This chapter describes the maintenance guidelines and troubleshooting procedures for this Prisma II module.

Qualified Personnel

Only appropriately qualified and trained personnel should attempt to maintain or troubleshoot these products.



WARNING:

Allow only qualified personnel to install, operate, maintain, or service this product. Otherwise, personal injury or equipment damage may occur.

In This Chapter

This chapter contains the following topics.

Topic	See Page
Module Maintenance	5-2
General Troubleshooting Information	5-3
Troubleshooting Alarm Conditions	5-4

Module Maintenance

Maintaining the Prisma Module

To ensure optimal performance, the following maintenance is recommended.

Frequency	Maintenance Required
Yearly	<ul style="list-style-type: none">• Check all parameters and test points• Record data• Make adjustments as needed• Make sure all cables are mated properly• Inspect cables for stress and chafing• Make sure all retaining screws are tight• Replace chassis air filter (Depending on office environment cleanliness/filtration, the chassis air filter may require more frequent servicing.)
When needed	Carefully clean the module with a soft cloth that is dampened with mild detergent

Maintenance Record

It may be helpful to establish a maintenance record or log for this module. You may want to record optical input level, optical output level, or laser current levels, as well as the filter change dates.

Large variations in any of the parameters above should be investigated prior to failure.

General Troubleshooting Information

Introduction

This troubleshooting information describes the most common alarms and gives typical symptoms, causes, and items to check before contacting Customer Service.

Equipment Needed

You may need the following equipment to troubleshoot the chassis.

- Digital voltmeter
- Fiber connector cleaning materials

Additional Assistance

If you need additional assistance contact Cisco Services.

Troubleshooting



WARNING:

Avoid electric shock and damage to this product! Do not open the enclosure of this product. There are no user-serviceable parts inside. Refer servicing to qualified service personnel.

Refer to the following section, **Troubleshooting Alarm Conditions**, to identify and correct optical amplifier faults.

Troubleshooting Alarm Conditions

Alarm Conditions

If the red ALARM indicator is illuminated or is blinking, check the ICIM, LCI, or TNCS to determine the cause of the alarm. For help, refer to the chart below.

Alarm	Parameter	Possible Causes	Possible Solutions
LasBias	Laser Current	Internal problem	Contact Cisco Services for help.
InPwr	Optical Input	Dirty or loose connector, or Low input	Check input source.
OutPwr	Optical Output	Low input, Internal problem	Check input. Contact Cisco Services for help.
		Module disabled	Enable Module.
LasTemp	Laser Temperature	Internal problem, Fan Tray failure, Ambient Temperature, or chassis air filter requires changing	Contact Cisco Services for help.
IntPs	Input Power Supply	Internal problem	Contact Cisco Services for help.

Chapter 6

Customer Information

If You Have Questions

If you have technical questions, call Cisco Services for assistance. Follow the menu options to speak with a service engineer.

Access your company's extranet site to view or order additional technical publications. For accessing instructions, contact the representative who handles your account. Check your extranet site often as the information is updated frequently.

Appendix A

Module Parameter Descriptions

Overview

Introduction

This appendix contains technical information that will assist you in configuring and operating this module.

In This Appendix

This appendix contains the following topics.

Topic	See Page
Operating Status Parameters	A-2
Configurable Parameters	A-3
Alarm Parameters	A-4
Manufacturing Data Parameters	A-5

Operating Status Parameters

Introduction

The following table describes the monitored operating parameters for this module.

Parameter Name (LCI)	ICIM Abbrev.	Function	Units
Optical Input Power	InPwr	Optical input power.	dBm
Optical Output 1 Power	OutPwr1	Laser 1 optical output power.	dBm
Optical Output 2 Power	OutPwr1	Laser 2 optical output power.	dBm
Laser 1 Temperature	LasTemp1	Laser 1 temperature.	deg C
Laser 2 Temperature	LasTemp2	Laser 2 temperature.	deg C
Laser 1 Limit	LasLim1	Laser 1 operating current limit.	A
Laser 2 Limit	LasLim2	Laser 2 operating current limit.	A
Laser 1 Bias Current	LasBias1	Laser 1 operating current.	A
Laser 2 Bias Current	LasBias2	Laser 2 operating current.	A
Module Temperature	ModTemp	Module temperature.	deg C
Laser On Time	LaserOn	Laser in-service hours.	Hrs
Enable Laser	Enable	Laser on or off.	ON or OFF
Optical Power Attenuation	SetAtten	Reduce optical power 0-3 dB in 0.5 dB steps.	dB
Operational Mode	Master	Master or Slave operation.	ON or OFF
Service Mode Ports A	ServiceA	Reduce optical power to 10 dBm.	ON or OFF
Service Mode Ports B	ServiceB	Reduce optical power to 10 dBm.	ON or OFF

Configurable Parameters

Introduction

The following table describes the configurable parameters for this module.

Parameter Name (LCI)	ICIM Abbrev.	Function	Values	Default
Enable Laser	Enable	Turns optical amplifier on or off.	ON or OFF	ON
Operational Mode	Master	Configures the module as Master or Slave. If set to Slave, will only start with an external alarm signal.	Master (ON) or Slave (OFF)	Master (ON)
Optical Power Attenuation	SetAtten	Decrease optical power.	0 dB to 3 dB in 0.5 dB steps	0 dB
Service Mode Port A	ServiceA	Decreases optical power on Port A to 10 dBm to allow servicing of that port.	ON or OFF	OFF
Service Mode Port B	ServiceB	Decreases optical power on Port B to 10 dBm to allow servicing of that port.	ON or OFF	OFF

Alarm Parameters

Introduction

The following table describes the alarm parameters for this module. Alarm limits are dependent on module type and configuration.

Alarm Name (LCI)	ICIM Abbrev.	Function	Threshold Values				Hys-teresis
			Major Low	Minor Low	Minor High	Major High	
Laser Bias Current *	LasBias	Laser bias current	-32 A	-32 A	-0.1 A	-0.01 A	0.001A
Optical Input Power *	InPwr	Optical input power	-15.0 dBm	-5.0 dBm	20.0 dBm	45.0 dBm	1.0 dBm
Optical Output Power *	OutPwr	Optical output power	-1.0 dBm	-0.7 dBm	0.7 dBm	1.0 dBm	0.1 dBm
Laser Temperature	LasTemp	Laser temperature	-20.0°C	-15.0°C	35.0°C	40.0°C	1.0°C
Laser Enabled Status	Enable	Module on or off	-	-	-	-	-
Internal Power Supply Status	IntPs	Power supply fault	-	-	-	-	-

* These are user alarms whose limits can be changed by the user. All other alarms are module alarms whose limits are set at the factory and cannot be changed by the user.

Manufacturing Data Parameters

Introduction

The following table describes the manufacturing data available for this module. Actual parameter values are dependent on module type and configuration.

Parameter Name (LCI)	ICIM Abbreviation	Typical Values
Generic Name	-	FTTx Post Amplifier
-	Module	1550 nm Optical EMT FTTx
Description	-	Optical Post-Amplifier
Software Revision	Sw Ver	1.14
Script Version	Script Ver	15
Serial Number	Serial #	AAFDAOP
Time of Service (initial value)	In Service Hours	0
Laser On Time (initial value)	-	0
-	Spec Data	16x19.5 dBm
Day Code	Date Code	C05
Module Type	Module Type	3018
-	Restore Factory Defaults	Restores module factory default configuration settings.

Glossary

AC	Alternate current
AGC	Automatic gain control
CAN	Cancel
DC	Direct current
DFB	Distributed feedback laser
EDFA	Erbium doped fiber amplifier
EIA	Electronics Industry Association
EMC	Electromagnetic compatibility
EMT	Externally-modulated transmitter
ESD	Electrostatic discharge
FHEDA	Forward Headend Driver Amplifier
HEDA	Headend Driver Amplifier
ICIM	Intelligent Communications Interface Module
I/O	Input/output
IP	Internet protocol
LCD	Liquid crystal display
LCI	Local craft interface
LED	Light emitting diode
MIB	Management Information Base
nm	Nanometers
NMS	Network Management System
OMI	Optical modulation index

Glossary, Continued

PLL	Phase Lock Loop. An electronic servo system controlling an oscillator to maintain a constant phase angle relative to a reference signal.
QAM	Quadrature amplitude modulation
RF	Radio frequency
RT	Remote terminal
RHEDA	Reverse Headend Driver Amplifier
RMA	Return material authorization
RX	Receive
SBS	Simulated Brillouin scattering
SMC	Signal management controller
SNMP	Simple Network Management Protocol
TEC	Thermo-electric cooler
TNCS	Transmission Network Control System
Torque	Force applied to bolt or screw to tighten the device
TX	transmit

Index

Accessing module details, 4-1, 4-12

- alarm limits, 4-25
- alarm status, 4-23
- alarm thresholds, 3-41
- ALARMS IN, 2-15
- ALARMS OUT, 2-15

Back panel, 1-6

- block diagram
 - double-wide modules, 1-4
- boot dialog, 3-36

Cable connection, 2-10

- change parameters, 3-37
- chassis
 - communications connections, 2-12
- chassis-to-chassis communications, 2-12
- checking
 - alarms, 3-21, 4-23
 - manufacturing data, 3-25, 4-27
 - operating status, 4-19
- cleaning optical connectors, 2-9
- Community Names, 3-32
- computer requirements, 4-3
- configuration and monitoring methods, 1-7
- configuring parameters, 4-21
- configuring parameters, 3-19
- connect computer to the chassis, 4-7

Equipment needed, 2-2, 5-3

Features, 1-3

- Fiber Fish tool, 2-8

- front access chassis illustration, 2-5
- front panel, 1-5

ICIM

- block diagram, 3-2
- front panel features, 3-4
- function, 3-2
- Keypad, 3-5
- LCD, 3-4
- LCD contrast, 3-13
- menu, 3-14, 3-15
- installing
 - LCI, 4-4
 - module, 2-6

Keypad

- ICIM, 3-5

LCI

- function, 4-2
- module tree, 4-1, 4-10

MAIN Menu, 3-15

- maintenance, 5-2
- master/slave operation, 2-15
- Modifying Alarm Limits, 4-25

Obtaining an RMA Number and Shipping Address, 6-4

- operating status, 3-17
- operating temperature, 2-3
- operation ICIM front panel, 3-3
- optical amplifier illustration, 1-5
- Optical Amplifier Software Menu, 3-16

Index, Continued

optical amplifiers operation, 1-3

Password

ICIM, 3-6

menu, 3-7

power and communications connector, 1-6

power requirements, 2-4

Prisma II cable kit, 2-13

pulling optical cable, 2-9

Rear access chassis illustration, 2-5

redundancy interface panel, 2-16

restart the ICIM, 3-31

Return Product for Repair, 6-4

RS-485 cable kit, 2-13

Saving current configuration, 3-27

set traps, 3-33

setting adjustable alarm thresholds, 3-22

site requirements, 2-3

SNMP, 3-28

SNMP Variables, 3-34

space requirements, 2-4

starting LCI, 4-8

STATUS Menus, 3-18

Support Telephone Numbers, 6-2

Tools needed, 2-2

troubleshooting, 5-3

troubleshooting alarm conditions, 5-4

User password, 3-8



Cisco Systems, Inc.
5030 Sugarloaf Parkway, Box 465447
Lawrenceville, GA 30042

678 277-1120
800 722-2009
www.cisco.com

This document includes various trademarks of Cisco Systems, Inc. Please see the Notices section of this document for a list of the Cisco Systems, Inc. trademarks used in this document.

Product and service availability are subject to change without notice.

© 2005, 2008, 2013 Cisco and/or its affiliates.

All rights reserved.

January 2013 Printed in USA

Part Number 78-4010846-01 Rev D