

Cisco TelePresence SX80, Codec Pro Using Extra Loudspeakers and Sound Reinforcement

A guide to providing a better auditory experience

D1536504

Produced: December 2018 for CE9.6

All contents © 2016-2018

Cisco Systems, Inc. All rights reserved.



What's in this guide

Contents

Introduction.....	3
Codec SX80: Use with Extra Loudspeakers (I)	4
Codec SX80: Use with Extra Loudspeakers (II).....	5
Codec SX80: Expanding Scenario to Include Local Presenter (I) ...	6
Codec SX80: Expanding Scenario to Include Local Presenter (II)...	7
MX700/800: Use with Extra Loudspeakers.....	8
MX700/800: Use with Extra Loudspeakers.....	9
MX700/800: Expanding Scenario to Include Local Presenter (I)...	10
MX700/800: Expanding Scenario to Include Local Presenter (II) ..	11
Codec Pro: Use with Extra Loudspeakers (I).....	12
Codec Pro: Use with Extra Loudspeakers (II)	13
Codec Pro: Expanding to Include Local Presenter (I)	14
Codec Pro: Expanding to Include Local Presenter (II)	15
Audio Console—Customizing the Audio Connections.....	16
The Audio Console Panel	17

Introduction

When using the Codec Pro or the SX80, you may want to use more than one pair of loudspeakers in the room to enhance the overall auditory experience.

When using the Codec Pro or SX80 with local sound reinforcement, extra loudspeakers are strongly recommended to ensure that people in the room get the good auditory experience.

To set up the system we recommend to use the Audio Console^{NEW}.

Alternatively, you may use parts of the **API** of the codec.

The use of Audio Console to set up a system for local reinforcement is discussed at the end of this document.

We recommend **delaying** the sound from the extra set of loudspeakers to take advantage of the Haas effect.

The **Haas effect** (also known as the Precedence effect) causes humans to localize sound sources in the direction of the first arriving sound despite the presence of a single reflection from a different direction. A single reflection arriving within 5–30ms can be up to 10dB *louder* than the direct sound without being perceived as a secondary auditory event.

To a listener located in sweet spot, the two extra loudspeakers will combine into a single phantom source and thus cause no violation of the single reflection requirement.



Typical scenarios when a codec is used with extra loudspeakers.



Typical scenarios when a local presenter (lecturer) uses a wearable microphone and local reinforcement is used to enhance the auditory experience in the room.

About Microphones and Echo Cancelling

If no more than 8 microphones are required, we do recommend that you stick to the 8 independent built-in echo cancelers of the codec. These are high-quality cancelers closely integrated with the internal mixer, loudspeaker sound processing and the general signal flow inside the codec.

The use of external echo cancelers will normally introduce additional delay with reduced lip-sync performance as a result. In addition, you will experience increased cost of installation and maintenance.

Note We do not recommend using local reinforcement in combination with SpeakerTrack.

Get Inspired

In need of a little inspiration when it comes to designing video meeting scenarios?

Check out Project Workplace (<https://projectworkplace.cisco.com/#/>) which may serve as inspiration when you want to build your perfect meeting scenarios, explore our collaboration products, and discover experiences.

Codec SX80: Use with Extra Loudspeakers (I)

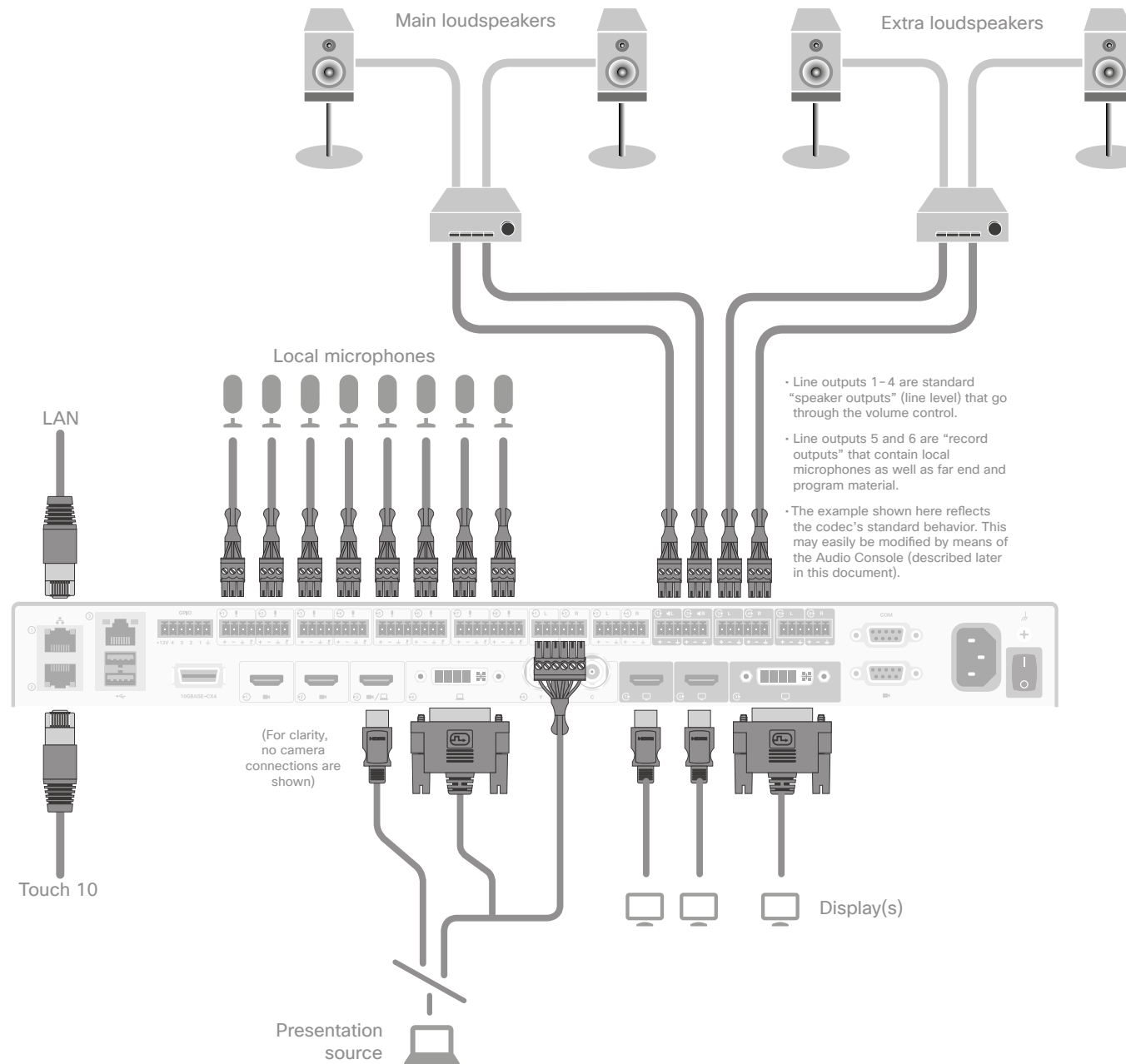

Connecting to the Codec

The illustration at left shows the external connections needed. Note that, for clarity, the camera connections have been omitted.

The illustration shows a configuration using passive loudspeakers and a power amplifier. Active loudspeakers (with built-in power amplifiers) may, of course, be used instead.

You may use any number of local microphones. Shown here is the maximum number the codec supports, which is 8 microphones—see also [“About Microphones and Echo Cancelling” on page 3](#).

Your presentation source may be connected using either HDMI or DVI. In the latter case, audio must be provided separately to the codec, as shown.

For clarity, the HDMI PC-input audio alternative has been omitted in the illustration of the internal signal paths shown on the following page.

Codec SX80: Use with Extra Loudspeakers (II)

- For the initial configuration when setting this up, we recommend the use of a sound source connected to the video system as “local presentation outside a call”. Make sure you use a signal with a representative content and signal level, as well as sufficient dynamic range. Recorded speech should be a part of this signal.

- We recommend that level setting on the audio output connectors is kept at its default value (-10)

The extra loudspeakers’ level should then be set as suitable, using the loudspeakers’ own gain controls.

This will leave a range of -14 dB to +10 dB available for further adjustments, which will be needed if compensation for many people present in the room calls for a different level.

- Define a sweet spot (normally the position where things should sound the best).

- Measure the distance between the sweet spot and all of the loudspeakers, as shown at right.

- You should now introduce a delay to the sound from each of the extra loudspeakers.

This delay will correspond to the distances $l_1 - l_3$ and $l_2 - l_4$.

As a rule of thumb, use 3 ms delay per meter.

- A further 5–30 ms of delay should be added to the calculated delay difference to take advantage of the Haas effect—see page 3 for more on this.

The exact amount of delay is difficult to predict, try listening to the entire system while adjusting the delay. Use the sweet spot.

Ideally, you should hear a rich sound without being very much aware of the presence of the extra loudspeakers, while at the same time it should be clearly noticeable when you switch off the extra loudspeakers.

- This delay adjustment may involve output level adjustment for the extra loudspeakers, but not necessarily.

- Use output level in the codec API to adjust the balance between the main and extra loudspeaker sets.

- The entire setup should then be tested with people in the room, alternatively with an amount of absorption material corresponding to such a situation.

This *may* call for further level adjustments, as outlined above.

- Be sure to make a video call to test that the far end experience has the quality required.

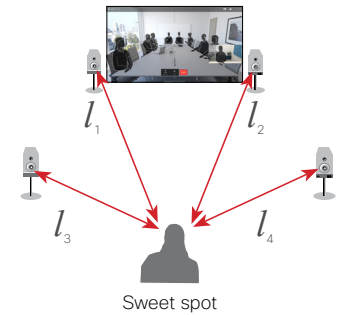

The sweet spot is normally the position where things should sound the best. We recommend that you apply a delay setting to the extra loudspeakers to make things sound better. This will require that you measure the distances shown—see text for more.

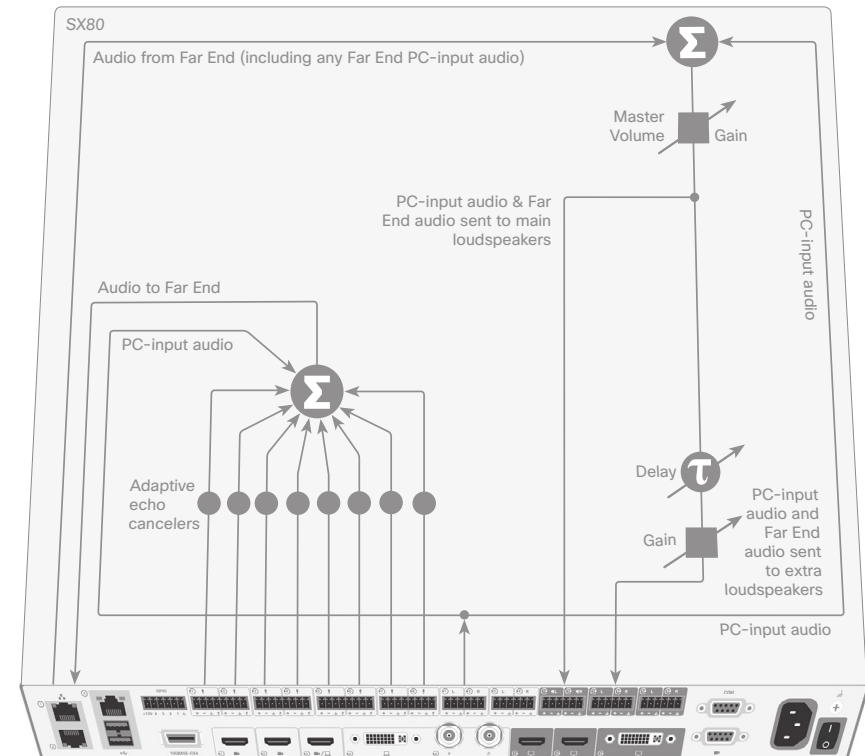

Codec SX80: Expanding Scenario to Include Local Presenter (I)

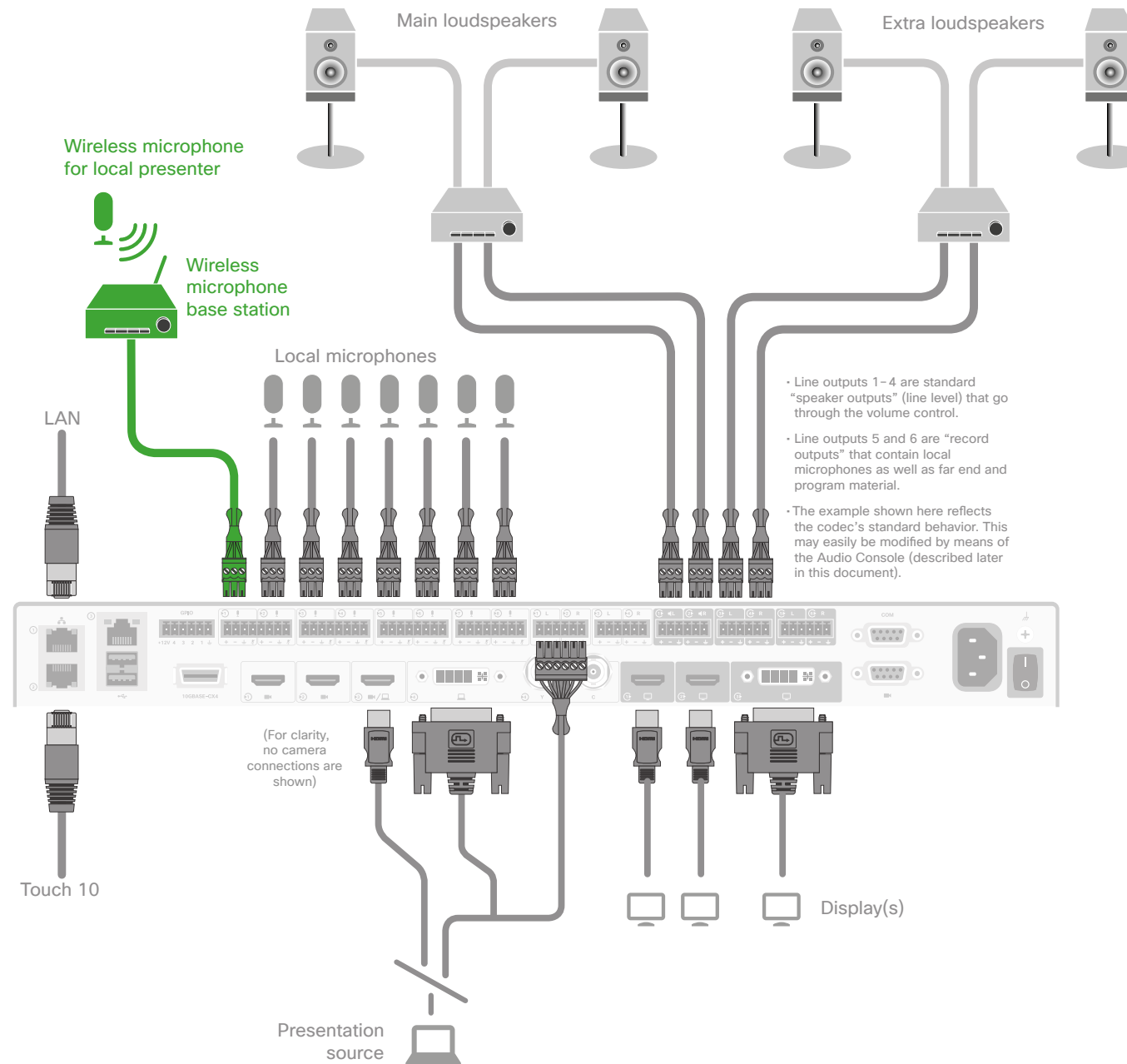

Connecting to the Codec

The illustration at left shows the external connections needed when expanding the scenario to include a local presenter. The only difference from the original scenario is the introduction of a wireless microphone and its base station (shown in green). The use of a wireless microphone is not mandatory, wired microphones may also be used. In addition, you may also use any of the microphone inputs for the local presenter. If you need more than one for this, use the number needed, just observe the danger of feedback if care has not been taken (see the following page for more on this).

Note that, for clarity, the camera connections have been omitted.

The illustration shows a configuration using passive loudspeakers and a power amplifier. Active loudspeakers (with built-in power amplifiers) may, of course, be used instead.

You may use any number of local microphones. Shown here is the maximum number the codec supports, which is 8 microphones—see also ["About Microphones and Echo Cancelling" on page 3](#).

In the illustration, the wireless microphone is connected to Input No. 1, but you may connect it to any of the 8 Inputs.

Your presentation source may be connected using either HDMI or DVI. In the latter case, audio must be provided separately to the codec, as shown.

For clarity, the HDMI PC-input audio alternative has been omitted in the illustration of the internal signal paths shown on the following page.

Codec SX80: Expanding Scenario to Include Local Presenter (II)

- We assume that you have already set up your SX80 to work with a set of extra loudspeakers, as described on the previous page.

- Use a dedicated (and closely mounted) microphone for the presenter, preferably of the wearable type.

This will ensure high quality audio with low loudness variation from the presenter and low sensitivity towards other audio sources. It is important that the presenter microphone does not pick up much of the audio from the loudspeakers, when local reinforcement of the presenter audio is used.

This serves to avoid strong reverberation, coloration and in the worst case feedback, of the presenter audio.

Other microphones in the room, e.g. ceiling mounted microphones may still be operating, but not as a substitute for the personal microphone.

- The wearable microphone will typically be of the wireless type with a base station.

In order to avoid clipping of the codec's microphone input, you may want to set the base station output to *Mic out*, rather than *Line out*.

If you do so, make sure the base station is not suffering damage from the phantom voltage supplied by the codec. See also Appendix for more.

- Another strategy will be to use *Line out* of the base station and reduce the input sensitivity of the codec accordingly.

The codec full scale level is 22 dBu. If you have a base station supplying e.g. 18 dBu, you should not set the codec input level higher than 4.

Each step of the codec input level setting corresponds to 1 dB gain. For more on this, consult the *SX80 Physical Interface Guide*.

- Furthermore, we do recommend that any kind of processing in the base station is avoided. We are here thinking of such things as dynamic EQ, compression, noise reduction, AGC, de-essing etc. These types of time-varying and/or non-linear processing may be detrimental to the codec's echo cancelling performance. Fixed EQ, however, should cause no problem.

- The input signal level from the wearable microphone should be checked using the VU-meter feature of the codec. Green with occasional appearances of yellow is considered good. Note that there is no peak hold, so testing by listening will be needed. Use the gain control of the microphone base station to adjust the microphone level, if needed.

- Adjust the gain settings so that the codec input levels are the same for all microphone inputs, for a given sound level.

Should you now need to adjust the sound level, use the following guidelines:

- Use Mixer Gain of the Audio Console to amplify the local presenter.
- Use Master Volume to amplify PC-input audio and far-end audio. The local presenter will not be affected by this.

- You may want to fine-tune the delay at this stage.

- The entire setup should then be tested with people in the room, alternatively with an amount of absorption material corresponding to such a situation.

This *may* call for further level adjustments, as outlined above.

- Be sure to make a video call to test that the far end experience has the quality required.

In the below example two microphones are used for the local reinforcement, feel free to use any number of the 8 microphones.

Note We do not recommend that you combine local reinforcement and SpeakerTrack.

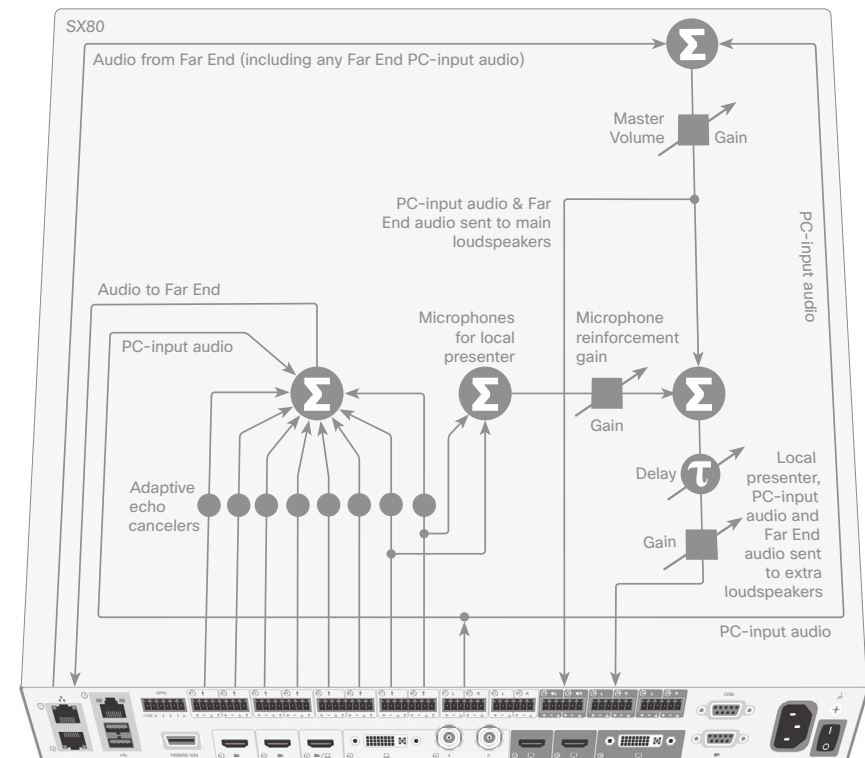

MX700/800: Use with Extra Loudspeakers

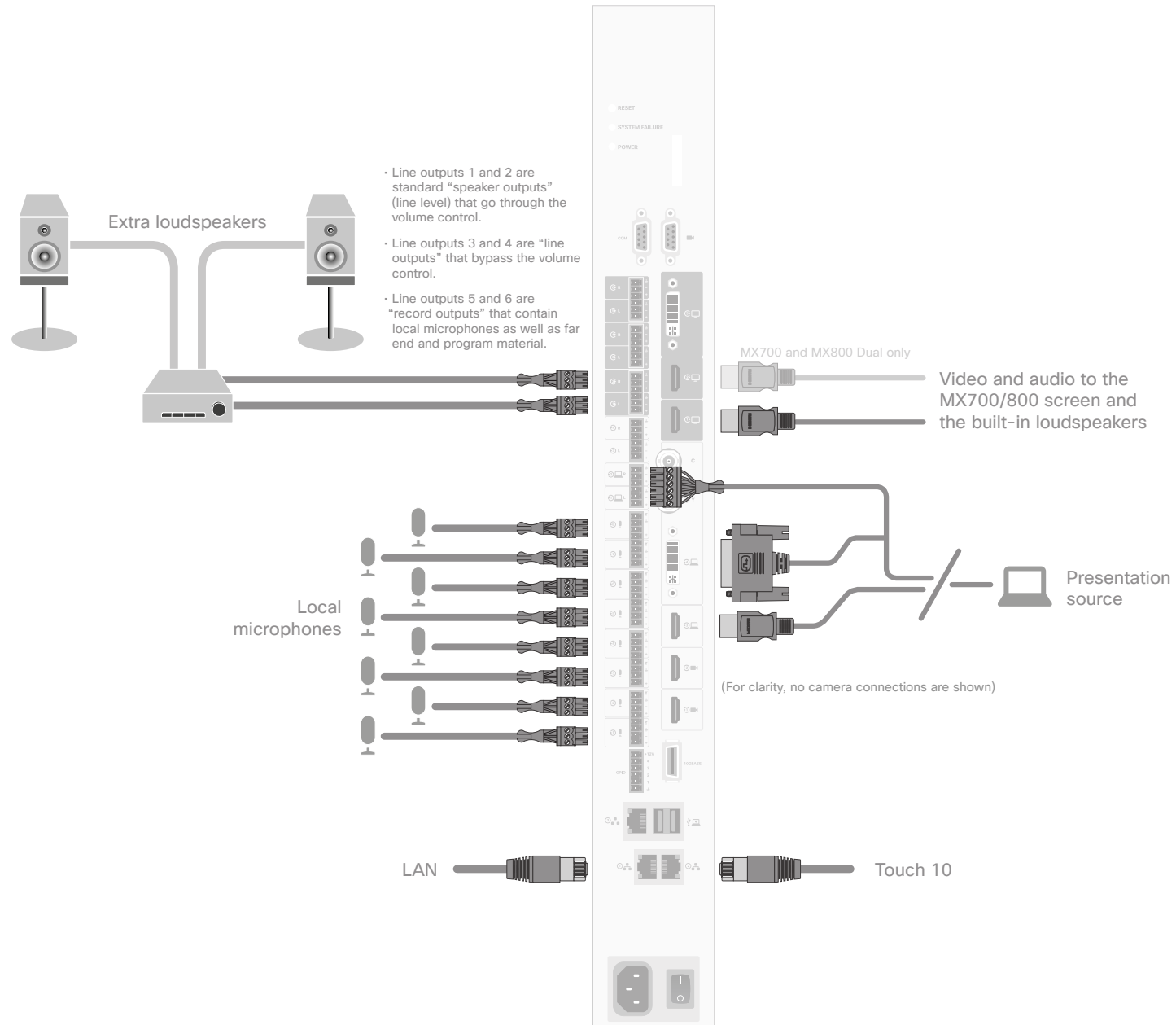

Connecting to the Endpoint

The illustration at left shows the external connections needed. Note that, for clarity, the camera connections have been omitted.

The illustration shows a configuration using passive loudspeakers and a power amplifier. Active loudspeakers (with built-in power amplifiers) may, of course, be used instead.

You may use any number of local microphones. Shown here is the maximum number the MX700/800 supports, which is 8 microphones—see also ["About Microphones and Echo Cancelling" on page 3](#).

Your presentation source may be connected using either HDMI or DVI. In the latter case, audio must be provided separately to the endpoint, as shown.

For clarity, the HDMI PC-input audio alternative has been omitted in the illustration of the internal signal paths shown on the following page.

MX700/800: Use with Extra Loudspeakers

- For the initial configuration when setting this up, we recommend the use of a sound source connected to the video system as “local presentation outside a call”. Make sure you use a signal with a representative content and signal level, as well as sufficient dynamic range. Recorded speech should be a part of this signal.

- We recommend that level setting on the audio output connectors is kept at its default value (-10).

The extra loudspeakers’ level should then be set as suitable, using the loudspeakers’ own gain controls.

This will leave a range of -14 dB to +10 dB available for further adjustments, which will be needed if compensation for many people present in the room calls for a different level.

- Define a sweet spot (normally the position where things should sound the best).

- Measure the distance between the sweet spot and both of the extra loudspeakers, as well as the distance between the sweet spot and the video system, as shown at right.

- You should now introduce a delay to the sound from each of the external loudspeakers.

This delay will correspond to the distances $l_3 - l_1$ and $l_3 - l_4$.

As a rule of thumb, use 3 ms delay per meter.

- A further 5–30 ms of delay should be added to the calculated delay difference to take advantage of the Haas effect—see page 3 for more on this.

The exact amount of delay is difficult to predict, try listening to the entire system while adjusting the delay. Use the sweet spot.

Ideally, you should hear a rich sound without being very much aware of the presence of the external loudspeakers, while at the same time it should be clearly noticeable when you switch off the external loudspeakers.

- This delay adjustment may involve output level adjustments, but not necessarily.
- Use Output level in the codec API to adjust the balance between the integrated and extra loudspeakers.

- The entire setup should then be tested with people in the room, alternatively with an amount of absorption material corresponding to such a situation.

This *may* call for further level adjustments, as outlined above.

- Be sure to make a video call to test that the far end experience has the quality required.

We do recommend the use of “Audio Console—Customizing the Audio Connections” on page 16 to set up this behavior.

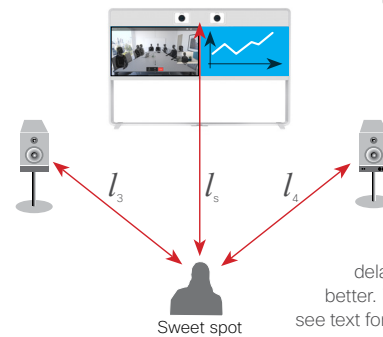
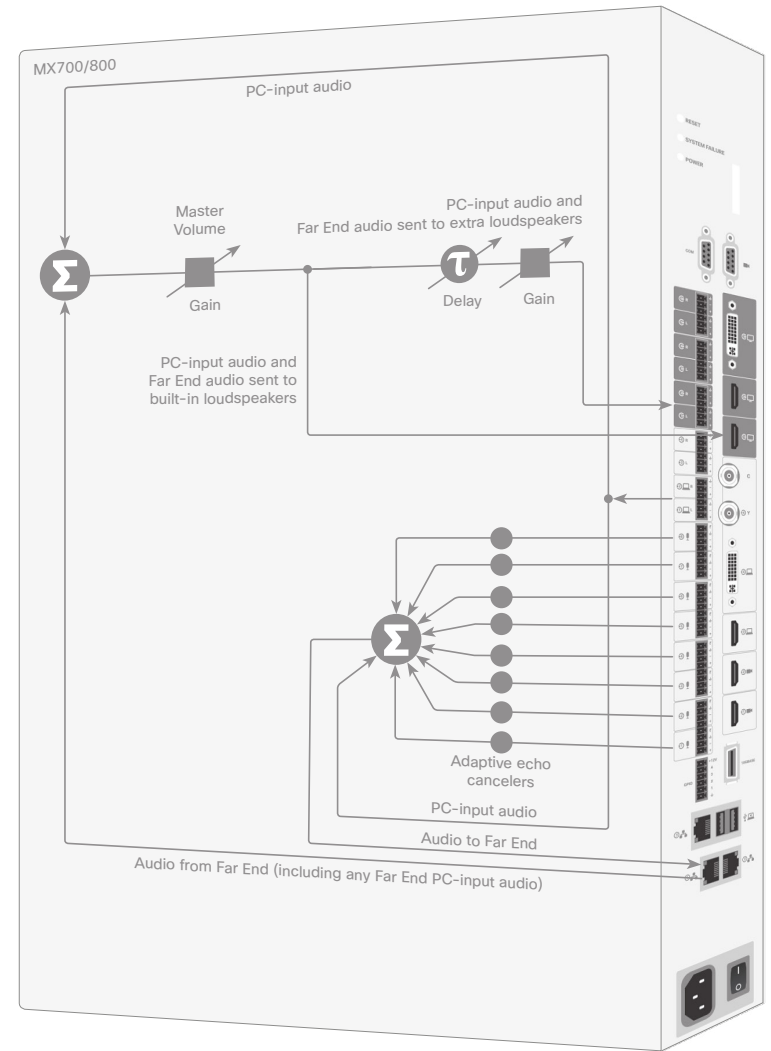

The sweet spot is normally the position where things should sound the best. We recommend that you apply a delay setting to the extra loudspeakers to make things sound better. This will require that you measure the distances shown—see text for more.

MX700/800: Expanding Scenario to Include Local Presenter

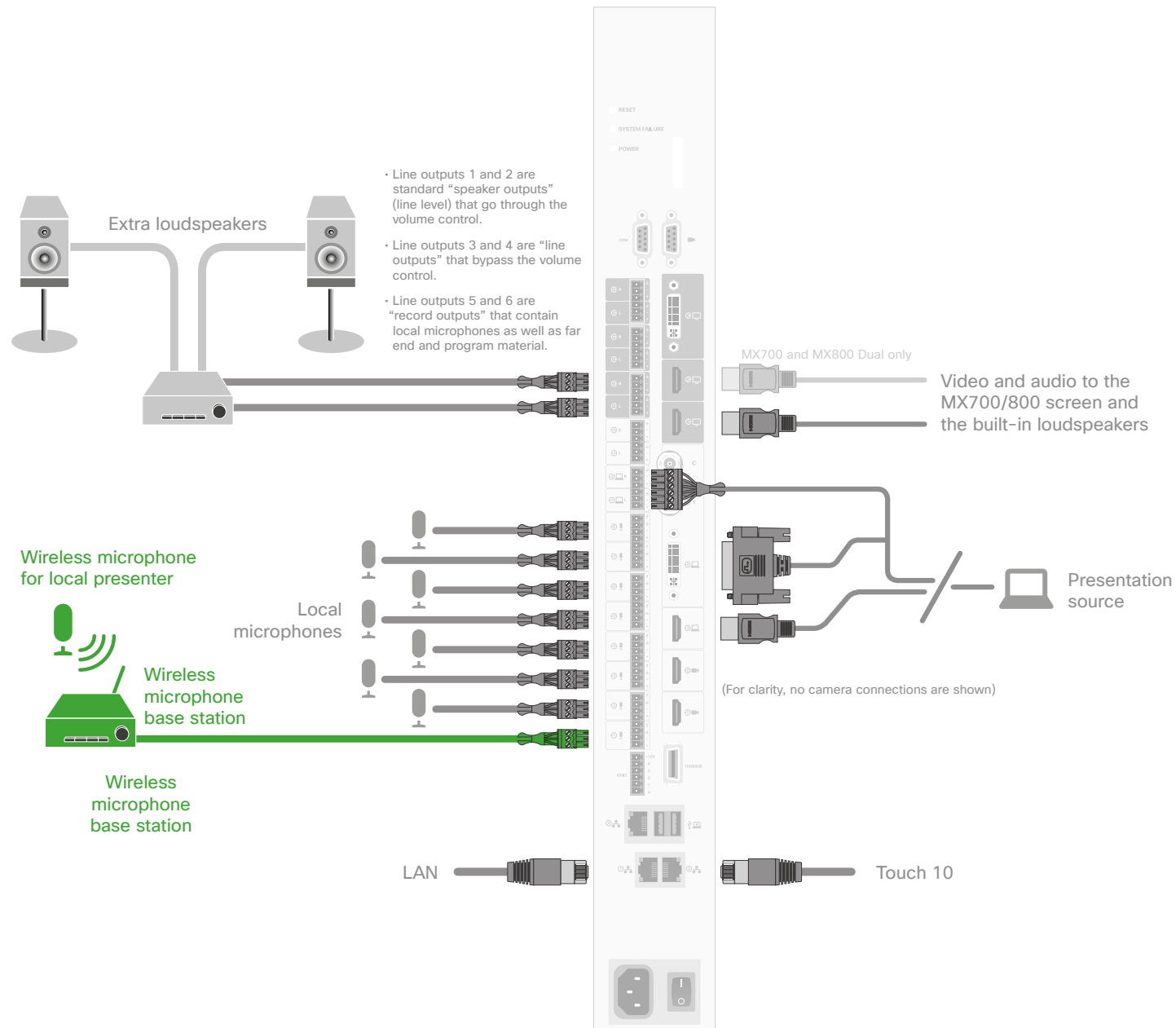

Connecting to the Endpoint

The illustration at left shows the external connections needed when expanding the scenario to include a local presenter. The only difference from the original scenario is the introduction of a wireless microphone and its base station (shown in green). The use of a wireless microphone is not mandatory, wired microphones may also be used. In addition, you may also use any of the microphone inputs for the local presenter. If you need more than one for this, use the number needed, just observe the danger of feedback if care has not been taken (see the following page for more on this).

Note that, for clarity, the camera connections have been omitted.

The illustration shows a configuration using passive loudspeakers and a power amplifier. Active loudspeakers (with built-in power amplifiers) may, of course, be used instead.

You may use any number of local microphones. Shown here is the maximum number the MX700/800 supports, which is 8 microphones—see also ["About Microphones and Echo Cancelling" on page 3](#).

In the illustration, the wireless microphone is connected to Input No.1, but you may connect it to any of the 8 Inputs.

Your presentation source may be connected using either HDMI or DVI. In the latter case, audio must be provided separately to the endpoint, as shown.

For clarity, the HDMI PC-input audio alternative has been omitted in the illustration of the internal signal paths shown on the following page.

MX700/800: Expanding Scenario to Include Local Presenter

- We assume that you have already set up your MX700/800 to work with a set of extra loudspeakers, as described on the previous page.
- Use a dedicated (and closely mounted) microphone for the presenter, preferably of the wearable type.

This will ensure high quality audio with low loudness variation from the presenter and low sensitivity towards other audio sources. It is important that the presenter microphone does not pick up much of the audio from the built-in loudspeakers of the MX700/800 or the extra loudspeakers, when local reinforcement of the presenter audio is used.

This serves to avoid strong reverberation, coloration and in the worst case feedback, of the presenter audio.

Other microphones in the room, e.g. ceiling mounted microphones may still be operating, but not as a substitute for the personal microphone.

- The wearable microphone will typically be of the wireless type with a base station.

In order to avoid clipping of the codec's microphone input, you may want to set the base station output to *Mic out*, rather than *Line out*.

If you do so, make sure the base station is not suffering damage from the phantom voltage supplied

by the codec. See also Appendix for more.

- Another strategy will be to use *Line out* of the base station and reduce the input sensitivity of the codec accordingly.

The codec full scale level is 22 dBu. If you have a base station supplying e.g. 18 dBu, you should not set the codec input level higher than 4.

Each step of the codec input level setting corresponds to 1 dB gain. For more on this, consult the *SX80 Physical Interface Guide*.

- Furthermore, we do recommend that any kind of processing in the base station is avoided. We are here thinking of such things as dynamic EQ, compression, noise reduction, AGC, de-essing etc. These types of time-varying and/or non-linear processing may be detrimental to the codec's echo cancelling performance. Fixed EQ, however, should cause no problem.
- The input signal level from the wearable microphone should be checked using the VU-meter feature of the codec. Green with occasional appearances of yellow is considered good. Note that there is no peak hold, so testing by listening will be needed. Use the gain control of the microphone base station to adjust the microphone level, if needed.
- Adjust the gain settings so that the codec input levels are the same for all microphone inputs, for a given sound level.

Should you now need to adjust the sound level, use the following guidelines:

- Use Microphone Reinforcement Gain to amplify the local presenter.
- Use Master volume to amplify PC-input audio and far-end audio. This will not influence the level of the local presenter.
- You may want to fine-tune the delay at this stage.
- Finally, the entire setup should then be tested with people in the room, alternatively with an amount of absorption material corresponding to such a situation.

This *may* call for further level adjustments, as outlined above.

- Be sure to make a video call to test that the far end experience has the quality required.

We do recommend the use of "Audio Console—Customizing the Audio Connections" on page 16 to set up this behavior.

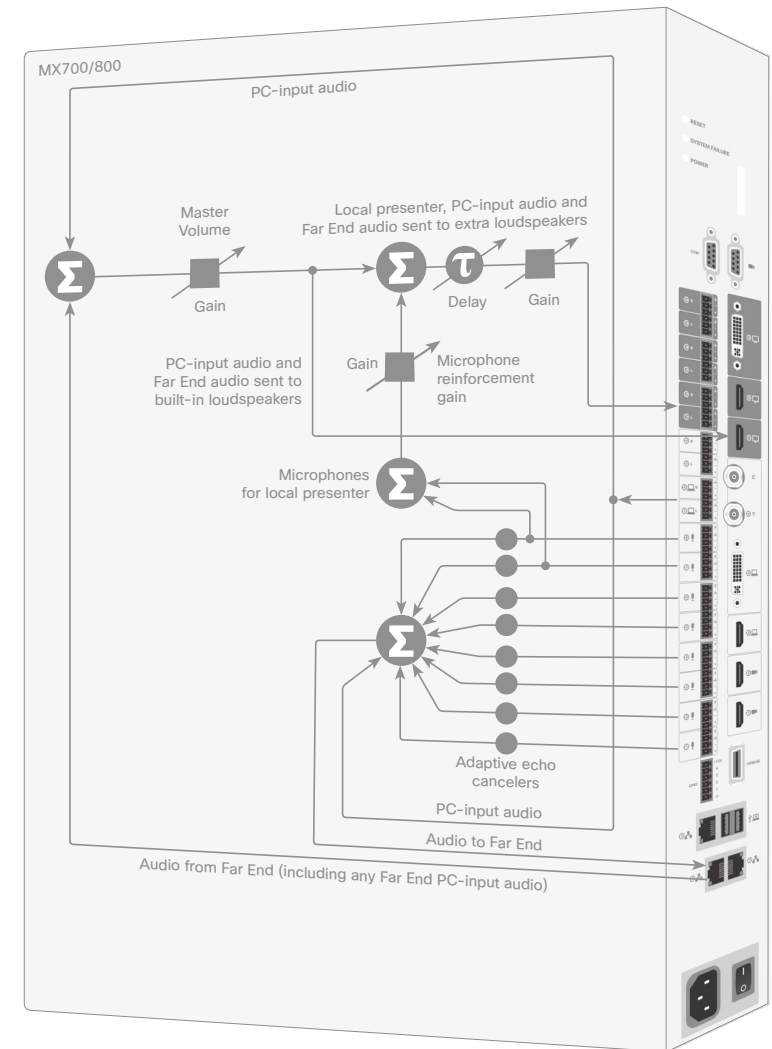

In the above example two microphones are used for the local reinforcement. This is just an example, feel free to use any number of the 8 microphones.

Note We do not recommend that you combine local reinforcement and SpeakerTrack.

Codec Pro: Use with Extra Loudspeakers (I)

Loudspeakers must be active or connected to a power amplifier.

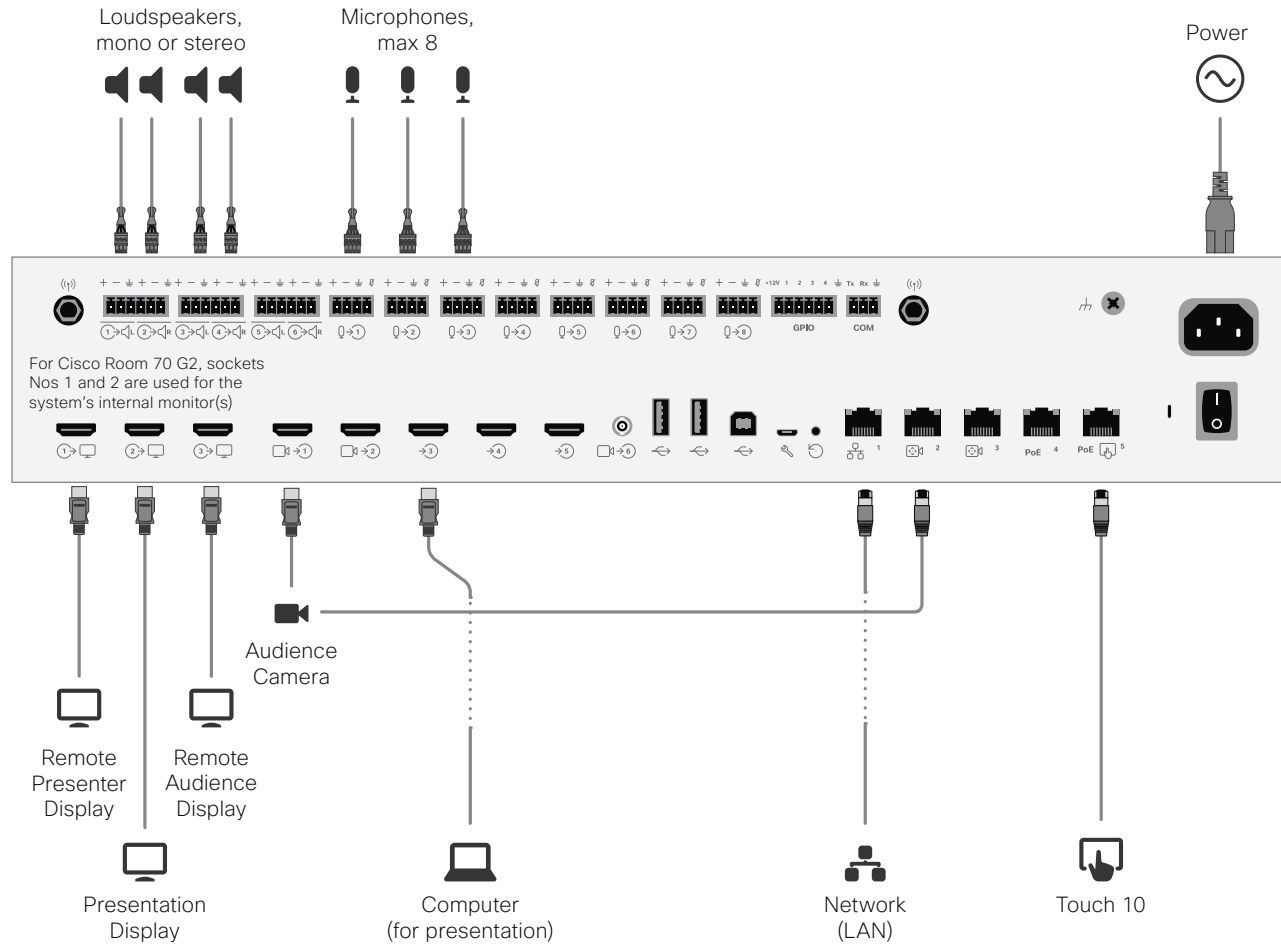

Connecting to the Codec

The Codec Pro section of this document applies to Cisco Room 70 G2 as well.

The illustration at left shows the external connections needed.

You may use any number of local microphones (up to 8) – see also [“About Microphones and Echo Cancelling” on page 3.](#)

Codec Pro: Use with Extra Loudspeakers (II)

- For the initial configuration when setting this up, we recommend the use of a sound source connected to the video system as “local presentation outside a call”. Make sure you use a signal with a representative content and signal level, as well as sufficient dynamic range. Recorded speech should be a part of this signal.

- We recommend that level setting on the audio output connectors is kept at its default value (-4)

The extra loudspeakers’ level should then be set as suitable, using the loudspeakers’ own gain controls.

This will leave a range of -20 dB to +4 dB available for further adjustments, which will be needed if compensation for many people present in the room calls for a different level.

- Define a sweet spot (normally the position where things should sound the best).

- Measure the distance between the sweet spot and all of the loudspeakers, as shown at right.

- You should now introduce a delay to the sound from each of the extra loudspeakers.

This delay will correspond to the distances $l_1 - l_3$ and $l_2 - l_4$.

As a rule of thumb, use 3 ms delay per meter.

- A further 5–30 ms of delay should be added to the calculated delay difference to take advantage of the Haas effect—see page 3 for more on this.

The exact amount of delay is difficult to predict, try listening to the entire system while adjusting the delay. Use the sweet spot.

Ideally, you should hear a rich sound without being very much aware of the presence of the extra loudspeakers, while at the same time it should be clearly noticeable when you switch off the extra loudspeakers.

- This delay adjustment may involve output level adjustment for the extra loudspeakers, but not necessarily.

- Use output level in the codec API to adjust the balance between the main and extra loudspeaker sets.

- The entire setup should then be tested with people in the room, alternatively with an amount of absorption material corresponding to such a situation.

This *may* call for further level adjustments, as outlined above.

- Be sure to make a video call to test that the far end experience has the quality required.

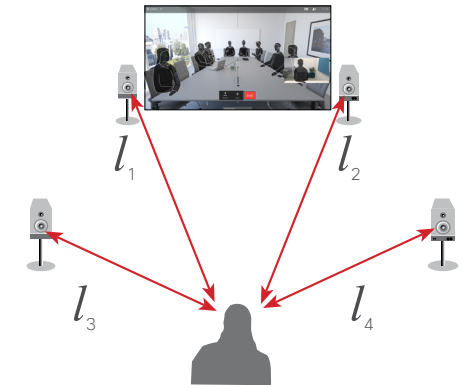

Tip: Use Audio Console to set things up in a web browser.

The sweet spot is normally the position where things should sound the best. We recommend that you apply a delay setting to the extra loudspeakers to make things sound better. This will require that you measure the distances shown—see text for more.

The below illustration shows the internal signal paths of the Codec Pro when used for local reinforcement with extra loudspeakers.

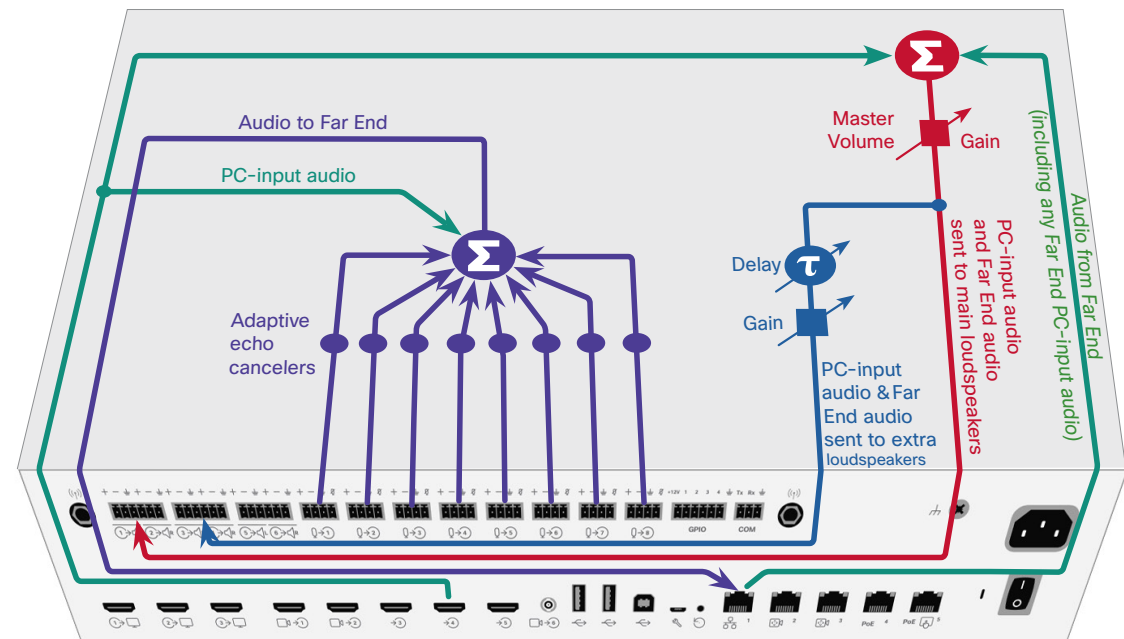

Codec Pro: Expanding to Include Local Presenter (I)

Loudspeakers must be active or connected to a power amplifier.

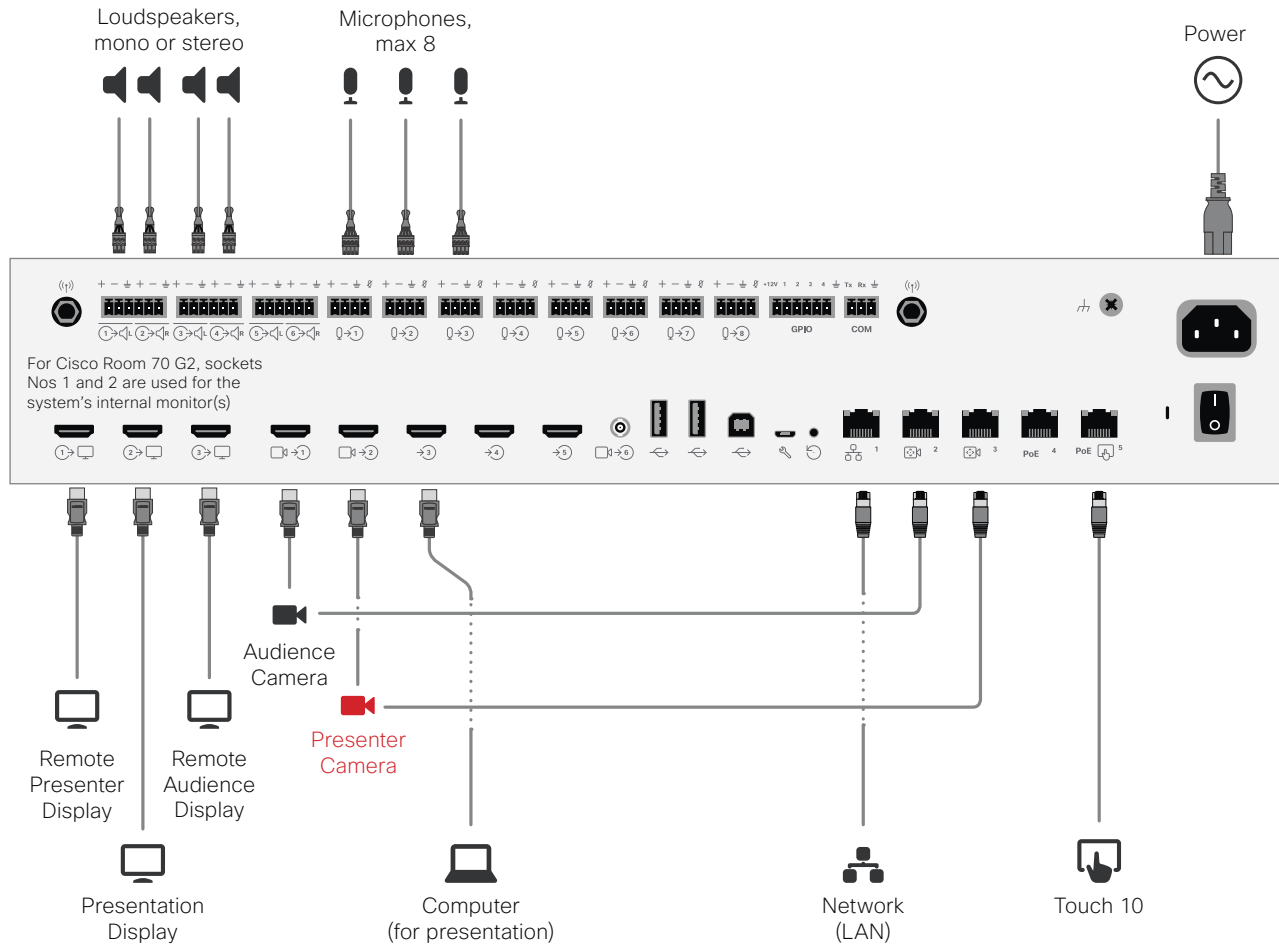

Connecting to the Codec

The Codec Pro section of this document applies to Cisco Room 70 G2 as well.

The illustration at left shows the external connections needed when expanding the scenario to include a local presenter. The only difference from the original scenario is that some of the microphones (one or more) are used by the local presenter. Microphones can be wired or wireless. However, it is important to get the microphone as close to the source as possible to minimize the required microphone gain and thereby maximize the feedback margin.

In addition, you may also use any of the microphone inputs for the local presenter. If you need more than one for this, use the number needed, just observe the danger of feedback if care has not been taken (see the following page for more on this).

This setup also includes a Presenter camera (shown in red).

You may use any number of local microphones.

Codec Pro: Expanding to Include Local Presenter (II)

- We assume that you have already set up your Codec Pro to work with a set of extra loudspeakers, as described on the previous pages.

- Use a dedicated (and closely mounted) microphone for the presenter, preferably of the wearable type.

This will ensure high quality audio with low loudness variation from the presenter and low sensitivity towards other audio sources. It is important that the presenter microphone does not pick up much of the audio from the loudspeakers, when local reinforcement of the presenter audio is used.

This serves to avoid strong reverberation, coloration and in the worst case feedback, of the presenter audio.

Other microphones in the room, e.g. ceiling mounted microphones may still be operating, but not as a substitute for the personal microphone.

- The wearable microphone will typically be of the wireless type with a base station.

In order to avoid clipping of the codec's microphone input, you may want to set the base station output to *Mic out*, rather than *Line out*.

If you do so, make sure the base station is not suffering damage from the phantom voltage supplied by the codec.

- Another strategy will be to use Line out of the base station and reduce the input sensitivity of the codec accordingly.

The codec full scale level is 22dBu. If you have a base station supplying e.g. 18dBu, you should not set the codec input level higher than 4.

Each step of the codec input level setting corresponds to 1dB gain. For more on this, consult the *Codec Pro Physical Interface Guide*.

- Furthermore, we do recommend that any kind of processing in the base station is avoided. We are here thinking of such things as dynamic EQ, compression, noise reduction, AGC, de-essing etc. These types of time-varying and/or non-linear processing may be detrimental to the codec's echo cancelling performance. Fixed EQ, however, should cause no problem.

- The input signal level from the wearable microphone should be checked using the VU-meter feature of the codec. Green with occasional appearances of yellow is considered good. Note that there is no peak hold, so testing by listening will be needed. Use the gain control of the microphone base station to adjust the microphone level, if needed.

- Adjust the gain settings so that the codec input levels are the same for all microphone inputs, for a given sound level.

Should you now need to adjust the sound level, use the following guidelines:

- Use Audio Console to amplify the local presenter.
- Use Master Volume to amplify PC-input audio and far-end audio. The local presenter will not be affected by this. Applies when the Output Group has been set to be Volume Controlled only.

- You may want to fine-tune the delay at this stage.

- The entire setup should then be tested with people in the room, alternatively with an amount of absorption material corresponding to such a situation.

This *may* call for further level adjustments, as outlined above.

- Be sure to make a video call to test that the far end experience has the quality required.

In the below example two microphones are used for the local reinforcement, feel free to use any number of the 8 microphones.

Note We do not recommend that you combine local reinforcement and SpeakerTrack.

The below illustration shows the internal signal paths of the Codec Pro when used for local reinforcement with extra loudspeakers and local presenter.

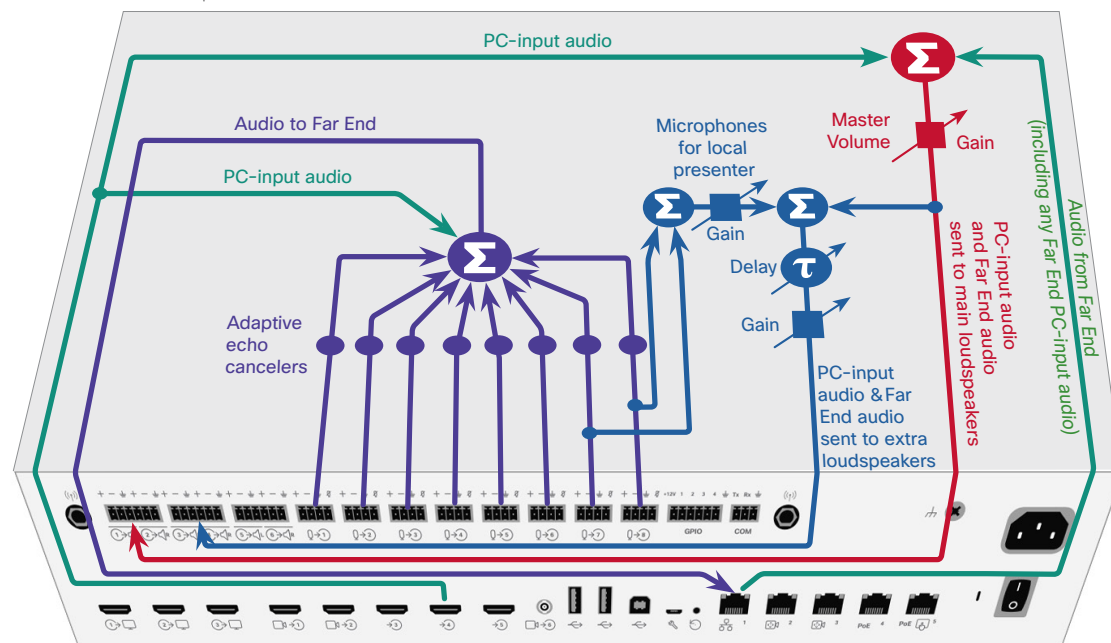

Audio Console – Customizing the Audio Connections

The Audio Console utility lets you define how audio inputs and outputs should be connected together, using simple drag and drop.

The Audio Console is available for systems using SX80 and Codec Pro.

The Audio Console can be found under Setup in the Web interface of your video system.

You start by defining logical input and output groups. The physical inputs and outputs are then assigned to those logical inputs and outputs.

New logical input and output groups may be added at all times. Likewise, you may remove logical modules at all times.

Changes applied to the settings are immediately put into effect. However, a codec restart will delete most of the settings, unless they have been saved to the codec before restarting. Hence, saving your settings is strongly recommended at all times.

The logical input and output groups can be given names defined by you.

A physical input, e.g. a microphone, can be assigned to more than one input. This comes in handy when working with local reinforcement, typically using a video system in lecture halls where the local audience also needs to hear what is being said through the microphone.

The Audio Console setup lets you utilize Echo Control on the part of the microphone signal that is sent to the far end, but at the same time omitting it for the part used locally (by assigning that microphone to more than one logical group). Use **Direct On** for this, see the next page for more on this..

You may also apply noise reduction and equalizer settings to the microphone signal.

A physical output cannot be assigned to more than a single logical output group.

In the Codec Pro, a Microphone input is a Line input with Phantom Feeding activated.

Using Audio Return Channels

HDMI offers, under certain circumstances, the ability to transmit audio in either direction. When audio is sent in reverse, this is referred to as an Audio Return Channel (ARC). The Codec Pro supports this.

Consider the below configuration, showing a Cisco QuadCam (top), a monitor (middle), and a Codec Pro (bottom) connected via HDMI. The QuadCam will act as both camera and soundbar in this setting.

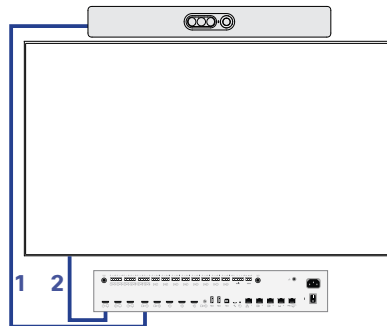

During normal use, the HDMI1 is used to provide the Codec Pro with video from the cameras of the QuadCam unit and the audio return channel of the same will be used to route the audio from the Codec Pro to the loudspeakers of the QuadCam.

However, if you want to use the setup as just a TV with a soundbar, the system will send audio from the monitor to the Codec Pro through HDMI out 1 (ARC) of Codec Pro and the Codec Pro will send that audio further to the QuadCam through HDMI1 in (ARC).

In order to be able to do this, the monitor must be CEC+ARC enabled. If your setup makes use of 4k video, make sure the monitor supports CEC+ARC in 4k format.

Where are the VU-meters?

To display the VU-meters, sign in to the web interface of the codec, then navigate to Setup > Peripherals and then down to the microphone VU-meters.

Alternatively go to Settings > Issues and Diagnostics > Microphone check on the Touch10 to display a VU-meter per microphone.

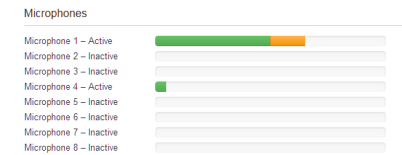

The Audio Console Panel

The Audio Console can be found under **Setup** in the Web interface of your video system.

The pool of physical Input connectors available.

The physical Input connectors are assigned to logical Input groups. These logical Input groups are created by you.

The name of a logical group is specified by you when clicking on **New input group**.

A given physical Input connector may be assigned to more than one logical group. Use Drag and Drop.

To remove a group or a member of a group hover the mouse over the group or member. An **X** will appear. Click on this to remove the item.

A member of a logical group may be expanded to gain access to setup details:

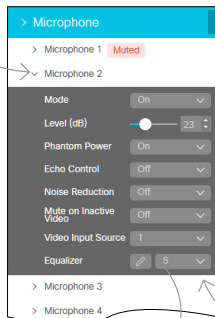

This is equalizer setting No. 5

Section	Type	Gain (dB)	Frequency (Hz)	Q
1	Peaking	0	100	1
2	Peaking	0	200	1
3	Peaking	0	500	1
4	Peaking	0	1000	1
5	Peaking	0	2000	1
6	Peaking	0	5000	1

To delete a connection or adjust its gain, right-click on the "cable".

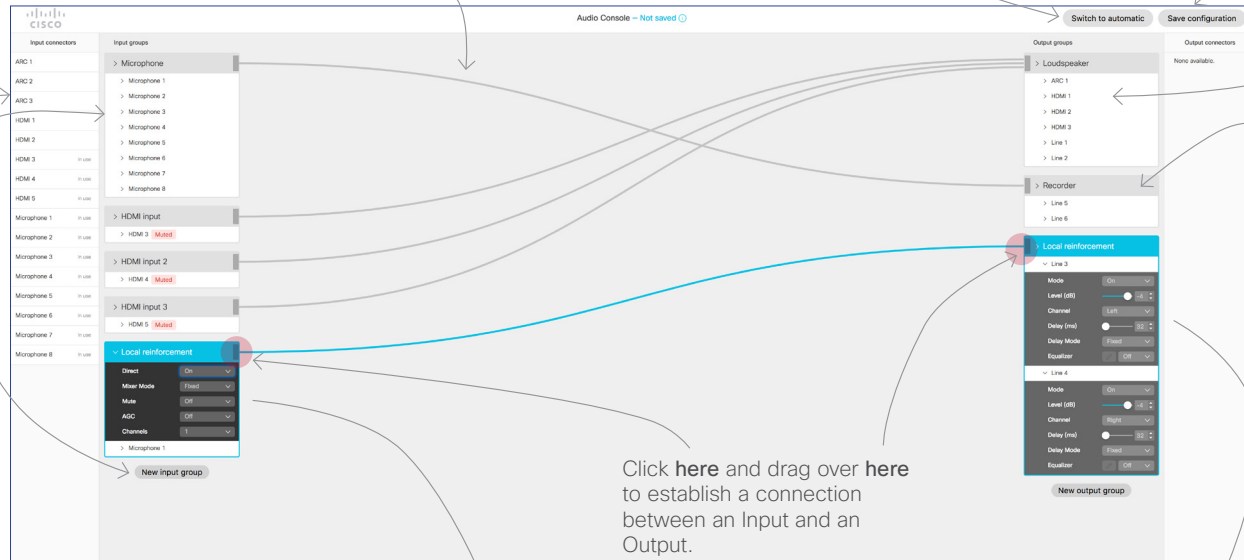

Click here and drag over here to establish a connection between an Input and an Output.

Expand the Logical group rather than the individual members of the Logical group when using it for local reinforcement.

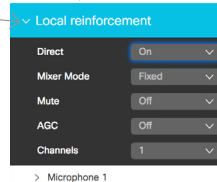

For local reinforcement scenarios, set microphones to **Direct**, see text below.

A few things to note:

The Codec Pro offers Audio Return Channels (ARC) as additional choices (see the previous page for more on this).

In the Codec Pro, a **Microphone input** is a **Line input** with **Phantom Feeding** activated.

In local reinforcement scenarios, make sure you set the **Microphone(s)** to **Direct** to bypass extra processing like Echo Control. This will minimize latency and also serve to avoid that the Master volume control also affects the volume of the local presenter.

Expand the logical group to gain access to this, as shown above.

For the Codec Pro and the Room 70 G2 there is an automatic mode available. This mode will create a preset of connections based on connected devices detected. You may then modify this to your liking.

Save new configuration to the video system.

This is the pool of physical Output connectors not yet used. They are therefore considered inactive.

The logical Output groups are similar to the logical Input groups, but a physical Output cannot be assigned to more than one logical Output group.

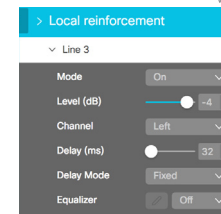

We recommend that you set **Delay Mode** to **Fixed** to avoid potential delay caused by external screens.

