

لخاد) FP9300 ىل ع FTD عىمجت نيوكت (للكيهل)

تايوتحمل

[عمدقمل](#)

[ةيساسأل تابلطتمل](#)

[تابلطتمل](#)

[عمدختسمل تانوكمل](#)

[ةيساسأ تامولعم](#)

[نيوكتل](#)

[ةكبش لىل طي طختل مسرل](#)

[FTD ةومحمل ةيرورضل تاهاول عاشن 1. ةمهمل](#)

[FTD ةومحمل عاشن 2. ةمهمل](#)

[FMC ىل \(FTD\) ةعرسل قئاف لاسرل اجمانرب ةومحمل ليچست 3. ةمهمل](#)

[FMC ىل ع ذفنمل ةانقلل ةي عرفل تاهاول نيوكت 4. ةمهمل](#)

[يساسأل لاصتال نم ققحتل 5. ةمهمل](#)

[Chassis Manager مدختسم ةهجاو نم ةومحمل ماظن طاقتل](#)

[ةومحمل ماظن نم عبات زاهج فذح 6. ةمهمل](#)

[ةحصلال نم ققحتل](#)

[اهجالص او اطاخال فاشكتس](#)

[ةلص تاذا تامولعم](#)

عمدقمل

زاهج ىل ع اهتحص نم ققحتل او ةومحمل ماظن ةزيم نيوكت ةيفيك دنتسمل اذه حضوي
FPR9300.

ماظن لىل وائل نيوكتل/تثبتل دنتسمل اذه يف ةدراول تامولعمل طغت: ريذحت
ةعجرتسمل داومل صيخرت) ةدحو لادبتس اارج ىل ع دنتسمل اذه قبطني ال. ةومحمل
- RMA)

ةيساسأل تابلطتمل

تابلطتمل

دنتسمل اذهل ةصاخ تابلطتم دجوت ال.

عمدختسمل تانوكمل

ةيلال ةيدامل تانوكمل او جماربل تارادصل ىل دنتسمل اذه يف ةدراول تامولعمل دنتست:

- 1.1(4.95) لغشي يذال Cisco Firepower 9300 نامأل زاهج

- (1213 ٻيٺ) 6.0.1 راڊصا لال هل ي غش ت م تي ي ذلا (FTD) Firepower ڊيڊت ڊص عاڊلا جم ان رب
- (1023 ٻيٺ) 6.0.1.1 راڊصا لال لغش ي (FMC) FireSIGHT Management Center

ٻه ڊحو او عا س: ل م عمل ل لامك ا تقو

ٻه صا خ ٻه ي ل م عم ٻه ئي ٻ ي ف ٻه ڊو ج و م ل ٻه زه ج ال ن م ڊن ت س م ل ا ڊه ي ف ٻه ڊرا و ل ا تام و ل عمل ا عاشن ا م ت تن ا ك ا ڊا (ي ضا رت ف). ح و س م م ن ي و ك ت ب ڊن ت س م ل ا ڊه ي ف ٻه م ڊ خ ت س م ل ٻه زه ج ال ا ع ي م ج ا ڊ ب ر م ا ي ال ل م ت ح م ل ل ر ي ث ا ت ل ل ك م ه ف ن م ڊ ك ا ت ف ، ل ي غ ش ت ل ا ڊ ي ق ك ت ك ب ش

ٻه ي سا س ا تام و ل عم

- ع ي م ج ي ل ع ل ك ي ه ل ل ل خ ا ڊ ع ي م ج ت ل ن ي و ك ت ك ن ك م ي ، FTD زا ه ج م ا ڊ خ ت س ا ب FPR9300 ي ف ٻه م و ع ڊ م ل ا ت ا ر ا ڊ ص ا ل ا
- 6. 2. ي ف ل ك ا ي ه ل ل ن ي ب ع ي م ج ت ل ل ل ا خ ڊ ا م ت
- ل خ ا ڊ ن ي م ض ت ل ل ٻه ب س ن ل ا ب . ٻه م و م ج م ل ا م ا ڙن م ك ح ت ط ا ب ت ر ا ك 48 ڊ ف ن م ل ا ٻه ا ن ق عاشن ا م ت ي م ا ڙن ت ا ل ا ص ت ا ل Firepower 9300 ٻه ي ف ل خ ل ل ٻه ح و ل ل ط ا ب ت ر ا ل ا ڊه م ڊ خ ت س ي ، ل ك ي ه ل ل ٻه م و م ج م ل ا
- ٻه را ڊ ا ل ا ٻه ج او ا ن ث ت س ا ب ، ٻه م و ع ڊ م ر ي غ ٻه ي ڊ ر ف ل ل ت ا ن ا ي ب ل ا ت ا ه ج او
- ٻه م و م ج م ل ا م ا ڙن ي ف ت ا ڊ ح و ل ا ع ي م ج ل ٻه را ڊ ا ل ا ٻه ج او ص ي ص خ ت م ت

ن ي و ك ت ل ا

ٻه ك ب ش ل ل ي ط ي ط خ ت ل ا م س ر ل ا

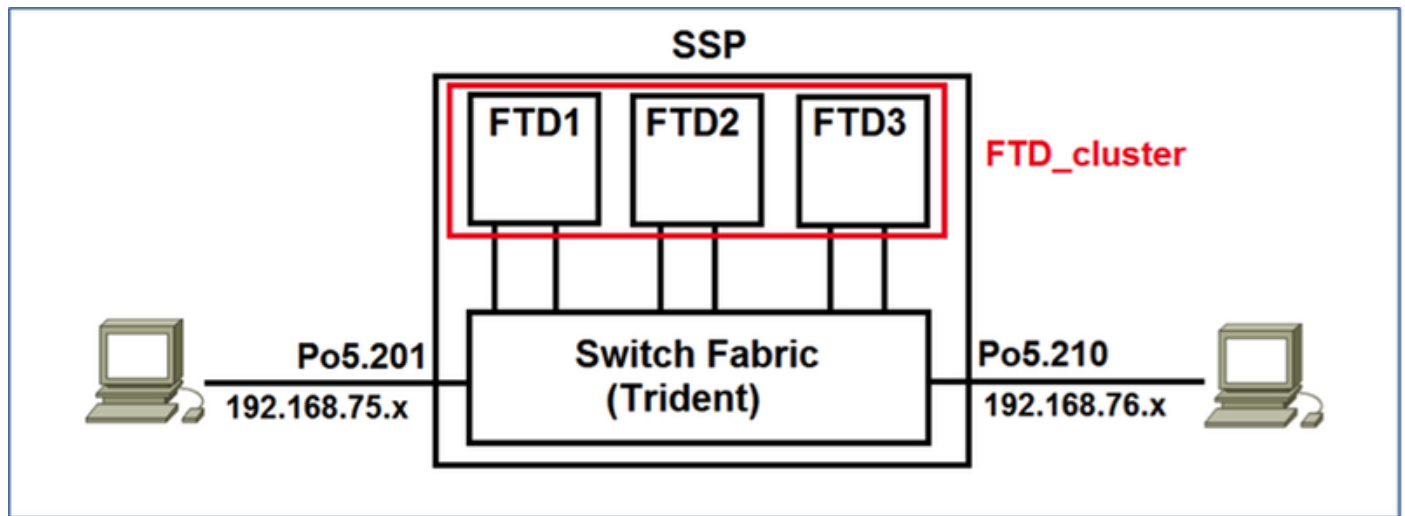

FTD ٻه م و م ج م ل ٻه ي ر و ر ض ل ل ا ت ا ه ج ا و ل ا عاشن ا 1. ٻه م ه م ل ا

ٻه م ه م ل ا ت ا ب ل ط ت م

ڊ ف ن م ٻه ا ن ق ت ا ڊ ت ا ن ا ي ب ٻه ج او و ٻه را ڊ ا ٻه ج او و ٻه م و م ج م ل ا م ا ڙن عاشن ا ب م ق

ل ح ل ا:

ڊ ف ن م ٻه ا ن ق ت ا ن ا ي ب ٻه ج او عاشن ا 1. ٻه و ط خ ل ا

ي ل ا ح ف ص ت ل ل ا و FPR9300 ل ك ي ه ل ل ر ي ڊ م ي ل ل ل و خ ڊ ل ا ل ي ج س ت ك ي ل ع ب ج ي ، ٻه ڊ ڊ ج ٻه ج او عاشن ا ل

تاهجاولا بيوبت ةمالع

تاملعملال هذه عم ةديج ذفنم ةانق ةهجاو ئشنأو ذفنم ةانق ةفاضل دح

ذفنملا ةانق فرعم	5
عونلا	تانايبلا
نيكمت	مغن
وضعلا فرعم	Ethernet1/3 و Ethernet 1/4

ةروصلال يف حضورم وه امك نيوكتلا ظفحل قفاوم دح

Add Port Channel

Port Channel ID: 5 Enable

Type: Data

Speed: 1gbps

Interfaces

Available Interface

Search

- Ethernet1/2
- Ethernet1/3
- Ethernet1/4
- Ethernet1/5
- Ethernet1/6
- Ethernet1/7
- Ethernet1/8
- Ethernet2/1
- Ethernet2/2
- Ethernet2/3
- Ethernet2/4
- Ethernet3/1
- Ethernet3/2

Member ID

- Ethernet1/3
- Ethernet1/4

Add Interface

OK Cancel

ةرادل ةهجاو عاشنإ 2. ةوطخلال

ةرادلال عون ةهجاو نيوكتو ريحت قوف رقناو، ةهجاولا رتخأ، تاهجاولا بيوبتلا ةمالع يف

ةروصلال يف حضورم وه امك نيوكتلا ظفحل قفاوم قوف رقنا

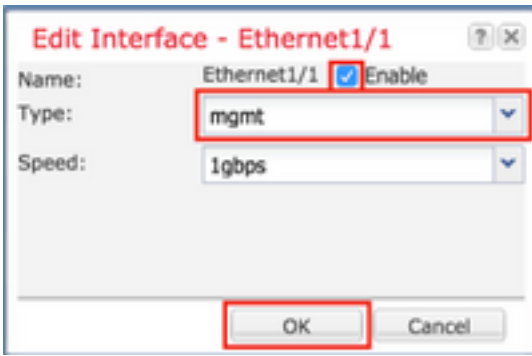

ةومجم لاطن ي ف مكحتلا طابترا ةءاوا ءاشنإ 3. ةوطخل

وه امك و تامل عمل هذه عم ةءءء ءفنم ءانق ةءاوا ءاشنإ ب مقو ءفنم ءانق ةفاضل رزل ع رقنا ةروصلال ي ف ءضوم.

ءفنم ل ءانق فرعم	48
ءونلا	ةومجم
نءكمء	مءن
وضع ل فرعم	-

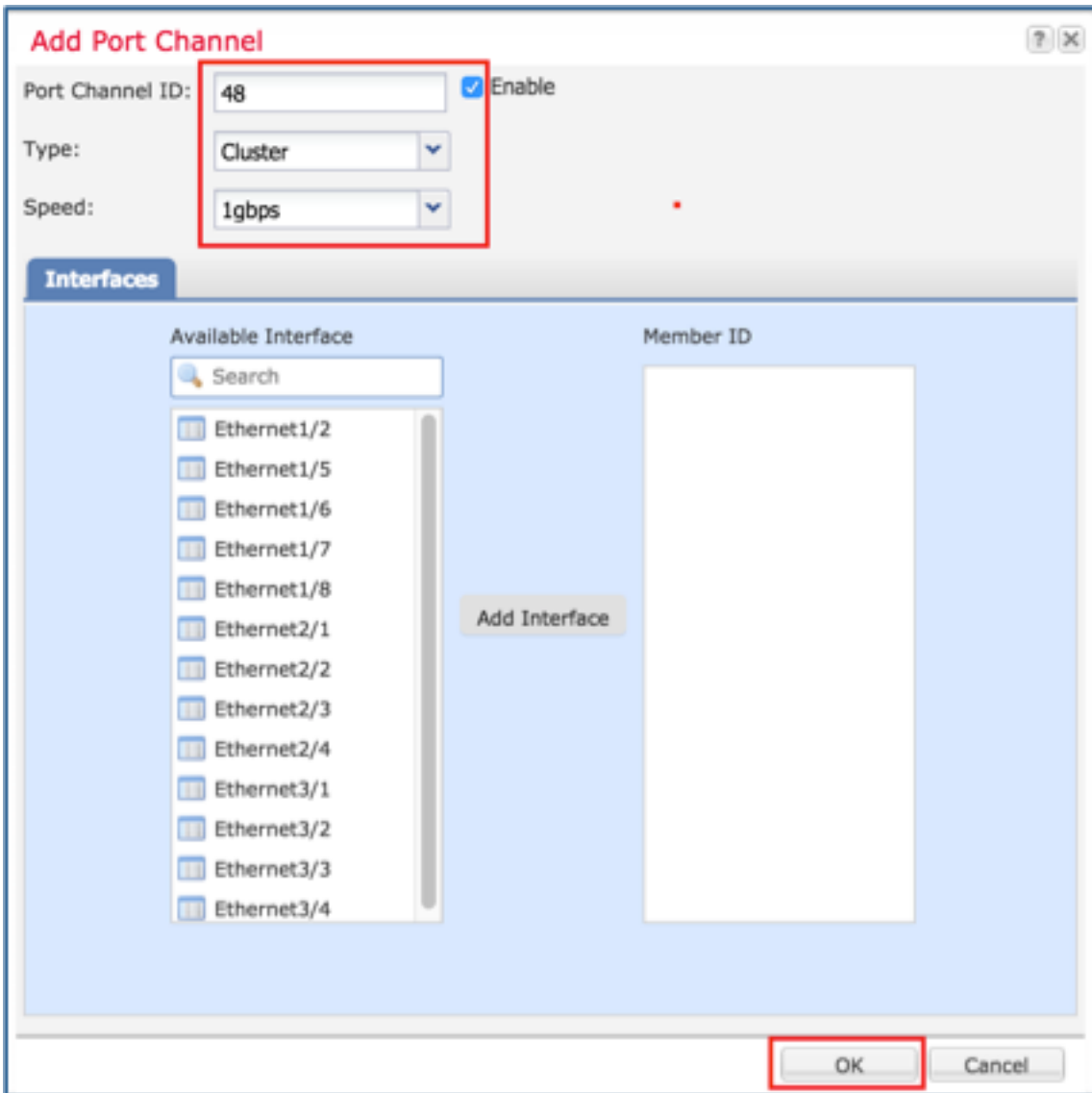

ةومجم ءاشنإ 2. ةمهمل

ةمهملا تابلطتم:

FTD ةومجم ماظن ةدحو ءاشنإ

لحل:

زاه ةفاضل رزىل ع رقناو ةيقتنم ةزهجأ لىل لقتنا 1. ةوطخلا

يلى امك FTD عيمجت ءاشناب مق

زاهجلا مسا	FTD_CLUSTER
بلاقلا	Cisco Firepower Threat Defense
ةروصلال رادصل	6.0.1.1213
زاهجلا عضو	ةومجم

ةروصلال ي ف حضوم وه امك OK، ةادألا تفضأ in order to ت ققط

Add Device

Device Name: FTD_cluster

Template: Cisco Firepower Threat Defense

Image Version: 6.0.1.1213

Device Mode: Standalone Cluster

OK Cancel

اهرشنو FTD ةومجم نيوك ت 2. ةوطخلا

Provisioning-device_name ةذفان لىل كهيجوت ةداعإ متت، FTD زاهج ءاشنإ دعب

ةروصلال ي ف حضوم وه امك نيوكتلا ءدبل زاهجلا زمر لىل ع رقنا

Overview Interfaces **Logical Devices** Security Modules Platform Settings System Tools Help admin

Provisioning - FTD_cluster
Clustered | Cisco Firepower Threat Defense | 6.0.1.1213

Data Ports

- Ethernet1/2
- Ethernet1/5
- Ethernet1/6
- Ethernet1/7
- Ethernet1/8
- Ethernet2/1
- Ethernet2/2
- Ethernet2/3
- Ethernet2/4
- Ethernet3/1
- Ethernet3/2
- Ethernet3/3
- Ethernet3/4
- Port-channel5



Security Module	Application	Version	Management IP	Gateway	Management Port	Status
Security Module 1	FTD	6.0.1.1213				
Security Module 2	FTD	6.0.1.1213				
Security Module 3	FTD	6.0.1.1213				

وه امك تادادع إله هذه مادخت ساب فTD ل ةومجم ل ا ماظن تامول عم بي وب ت ل ا ةمال ع ني وك ت ب مق ةروصل ا يف حضوم.

ةومجم ل ا ماظن حات فم cisco
ةومجم ل ا ماظن ةومجم م سا FTD_CLUSTER
ةراد إله ةه او Ethernet1/1

Cisco Firepower Threat Defense - Configuration ? X

Cluster Information Settings Interface Information Agreement

Security Module(SM)

Security Module-1,Security Module-2,Security Module-3

Interface Information

Cluster Key: *****

Cluster Group Name: FTD_cluster

Management Interface: Ethernet1/1

OK Cancel

ةروضلا يف حضورم وه امك وتادادعلا هذه مادختساب FTD تادادعلا بيوتلا عمال ع نيوكتب مق

ليجستلا حاتفم	cisco
رورملا عم لك	Admin123
ةرادلا زكرملا IP ناوع	10.62.148.73
Firepower	
ثحبلا تالاجم	cisco.com
ةيامحلا رادج عضو	هجوم
DNS مداوخ	173.38.200.100
وحن يلع لهؤم فيضم مسا	ksec-fpr9k-1-1-3.cisco.com
لمك	
ثادحالا ةهجاو	None

Cisco Firepower Threat Defense - Configuration [?] [X]

Cluster Information **Settings** Interface Information Agreement

Registration Key: *****

Password: *****

Firepower Management Center IP: 10.62.148.73

Search domains: cisco.com

Firewall Mode: Routed

DNS Servers: 173.38.200.100

Fully Qualified Hostname: ksec-fpr9k-1-1-3.cisco.com

Eventing Interface: None

OK Cancel

يفي حضورم وه امكو تادادعإلإ هذه مادختساب FTD ههجاو تامولعم بيوبتلا عمال ع نيوكتب مق ةروصللا.

ناونعلا عون	طاقف IPv4
1 ةيظمنلا نامألا ةدحو	
ةرادإلاب صاخلا IP ناونع	10.62.148.67
ةكبشلا عانق	255.255.255.128
ةباوبلا	10.62.148.1
Security Module 2 ةيظمنلا ةدحو	
ةرادإلاب صاخلا IP ناونع	10.62.148.68
ةكبشلا عانق	255.255.255.128
ةباوبلا	10.62.148.1
3 ةيظمنلا ةدحو	
ةرادإلاب صاخلا IP ناونع	10.62.148.69
ةكبشلا عانق	255.255.255.128
ةباوبلا	10.62.148.1

Cisco Firepower Threat Defense - Configuration ? X

Cluster Information Settings **Interface Information** Agreement

Address Type:	IPv4 only
Security Module 1 IPv4	
Management IP:	10.62.148.67
Network Mask:	255.255.255.128
Gateway:	10.62.148.1
Security Module 2 IPv4	
Management IP:	10.62.148.68
Network Mask:	255.255.255.128
Gateway:	10.62.148.1
Security Module 3 IPv4	
Management IP:	10.62.148.69
Network Mask:	255.255.255.128
Gateway:	10.62.148.1

OK Cancel

يفي حضوره وه امك قفاوم قوف رقناو ةيقافاتاللا بيوبتاللا ةمالع لىل ةيقافاتاللا لبقا ةروصللا.

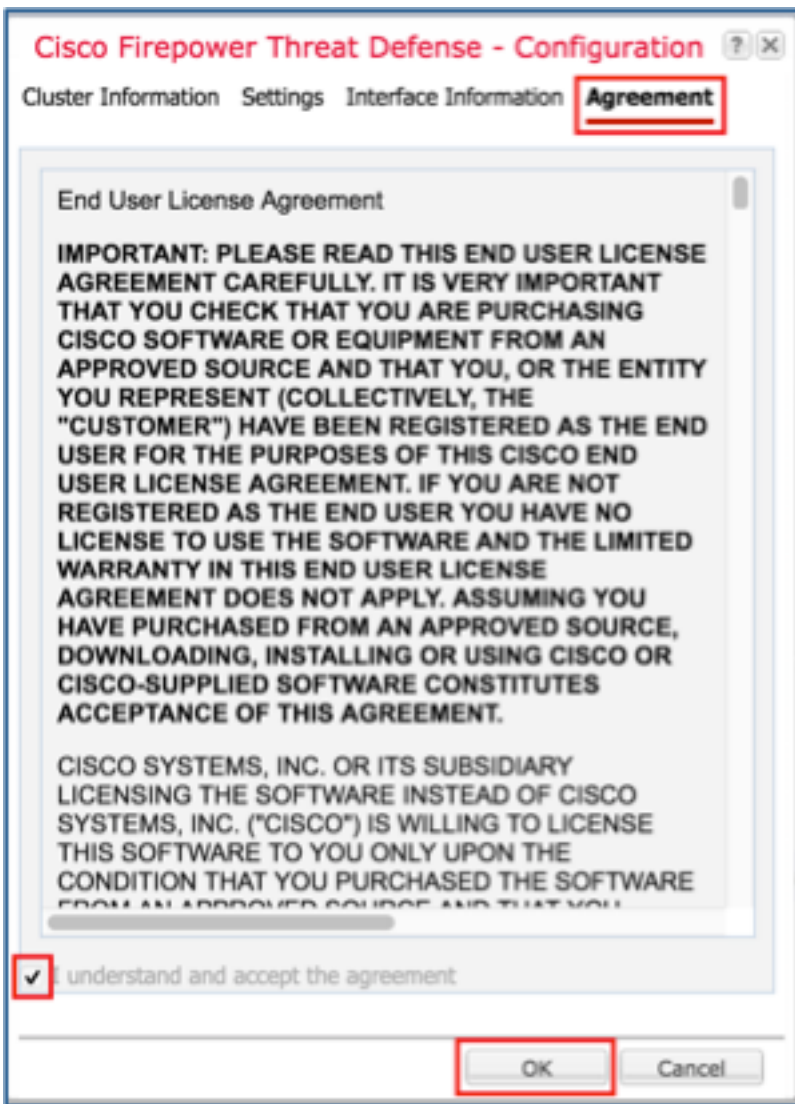

FTD ل تانايا بل تاهجاو صي صختب مق 3. ةوطخل

دعب FTD. يلع اهنبيعت دبرت ةهجاو لك يلع رقناو تانايا بل ذفانم ةقطنم عي سوتب مق ةروصلال يف حضوم وه امك FTD ةومجم عاشنال ظفح دح، لامك إلال

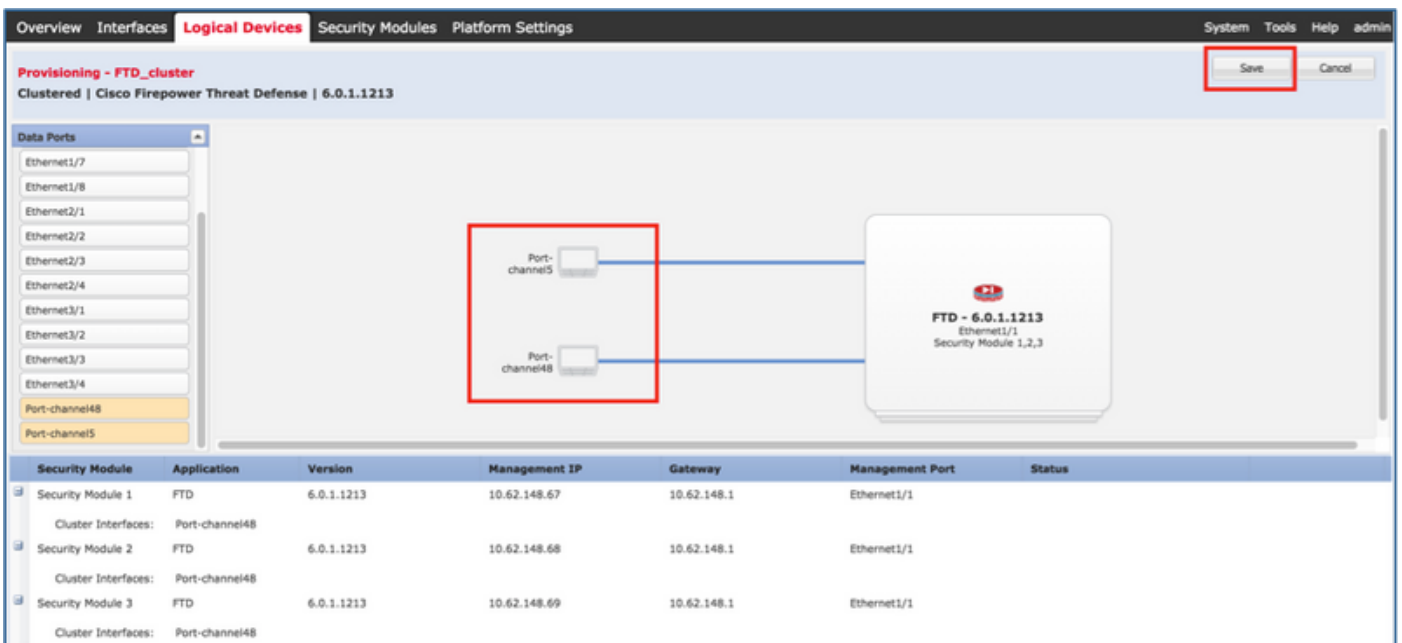

ةدحو لا راي تخ إةي لمع ءارج م تي كل ذدعبو، ةومجم ل ماظن رشن م تي تحت قئاق د عض بل رظتنا

ةيسئزلا.

ققحتلا

- ةروصللا يف حضوم وه امك FPR9300 زارط (GUI) ةيموسرلا مدختسمل ةهجاو نم

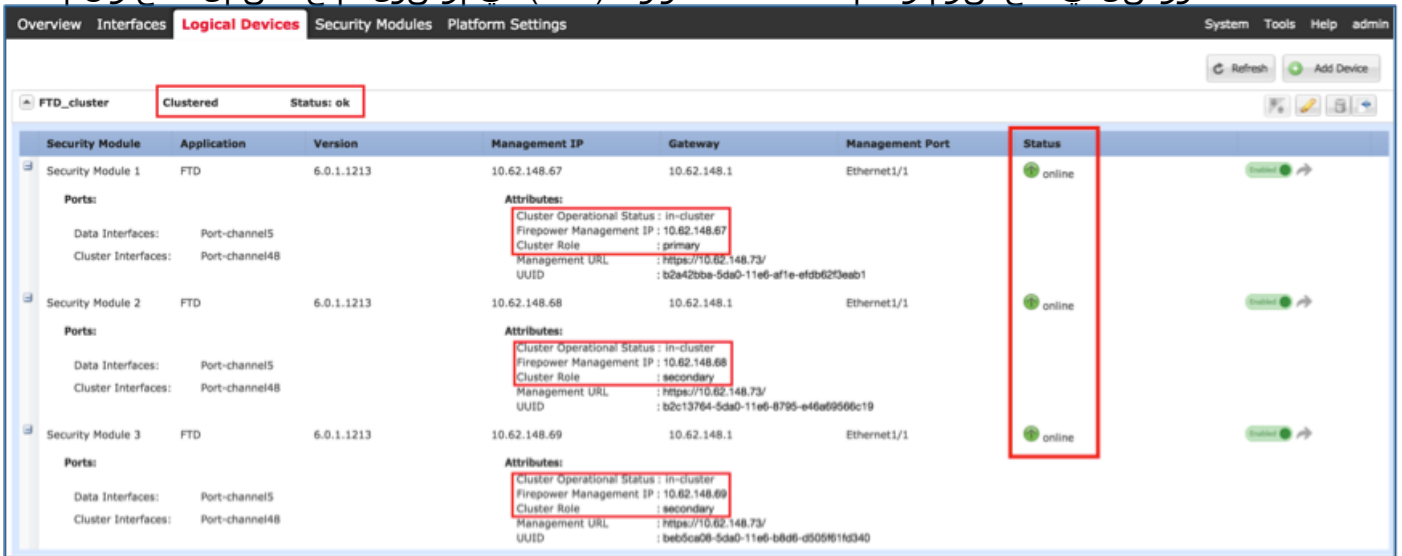

- نم FPR9300 CLI

```
FPR9K-1-A#
```

```
FPR9K-1-A# scope ssa
```

```
FPR9K-1-A /ssa # show app-instance
```

Application Name	Slot ID	Admin State	Operational State	Running Version	Startup
ftd	1	Enabled	Online	6.0.1.1213	6.0.1.1213
In Cluster					
ftd	2	Enabled	Online	6.0.1.1213	6.0.1.1213
In Cluster					
ftd	3	Enabled	Online	6.0.1.1213	6.0.1.1213
In Cluster					

- نم CLI (ASA) LINA

```
firepower# show cluster info
```

```
Cluster FTD_cluster: On
```

```
Interface mode: spanned
```

```
This is "unit-1-1" in state MASTER
```

```
ID : 0
```

```
Version : 9.6(1)
```

```
Serial No.: FLM19216KK6
```

```
CCL IP : 127.2.1.1
```

```
CCL MAC : 0015.c500.016f
```

```
Last join : 21:51:03 CEST Aug 8 2016
```

```
Last leave: N/A
```

```
Other members in the cluster:
```

```
Unit "unit-1-3" in state SLAVE
```

```
ID : 1
```

```
Version : 9.6(1)
```

```
Serial No.: FLM19206H7T
```

```
CCL IP : 127.2.1.3
```

```
CCL MAC : 0015.c500.018f
```

```
Last join : 21:51:05 CEST Aug 8 2016
```

Last leave: N/A
Unit "unit-1-2" in state SLAVE
ID : 2
Version : 9.6(1)
Serial No.: FLM19206H71
CCL IP : 127.2.1.2
CCL MAC : 0015.c500.019f
Last join : 21:51:30 CEST Aug 8 2016
Last leave: N/A

firepower# **cluster exec show cluster interface-mode**
cluster interface-mode spanned

unit-1-3:*****
cluster interface-mode spanned

unit-1-2:*****
cluster interface-mode spanned
firepower#

firepower# **cluster exec show cluster history**

```
=====
```

From State	To State	Reason
=====		
21:49:25 CEST Aug 8 2016		
DISABLED	DISABLED	Disabled at startup
21:50:18 CEST Aug 8 2016		
DISABLED	ELECTION	Enabled from CLI
21:51:03 CEST Aug 8 2016		
ELECTION	MASTER_POST_CONFIG	Enabled from CLI
21:51:03 CEST Aug 8 2016		
MASTER_POST_CONFIG	MASTER	Master post config done and waiting for ntfy
=====		

unit-1-3:*****

```
=====
```

From State	To State	Reason
=====		
21:49:44 CEST Aug 8 2016		
DISABLED	DISABLED	Disabled at startup
21:50:37 CEST Aug 8 2016		
DISABLED	ELECTION	Enabled from CLI
21:50:37 CEST Aug 8 2016		
ELECTION	ONCALL	Received cluster control message
21:50:41 CEST Aug 8 2016		
ONCALL	ELECTION	Received cluster control message
21:50:41 CEST Aug 8 2016		
ELECTION	ONCALL	Received cluster control message
21:50:46 CEST Aug 8 2016		
ONCALL	ELECTION	Received cluster control message

```

21:50:46 CEST Aug 8 2016
ELECTION          ONCALL          Received cluster control message

21:50:51 CEST Aug 8 2016
ONCALL           ELECTION         Received cluster control message

21:50:51 CEST Aug 8 2016
ELECTION          ONCALL          Received cluster control message

21:50:56 CEST Aug 8 2016
ONCALL           ELECTION         Received cluster control message

21:50:56 CEST Aug 8 2016
ELECTION          ONCALL          Received cluster control message

21:51:01 CEST Aug 8 2016
ONCALL           ELECTION         Received cluster control message

21:51:01 CEST Aug 8 2016
ELECTION          ONCALL          Received cluster control message

21:51:04 CEST Aug 8 2016
ONCALL           SLAVE_COLD       Received cluster control message

21:51:04 CEST Aug 8 2016
SLAVE_COLD       SLAVE_APP_SYNC   Client progression done

21:51:05 CEST Aug 8 2016
SLAVE_APP_SYNC   SLAVE_CONFIG     Slave application configuration sync done

21:51:17 CEST Aug 8 2016
SLAVE_CONFIG     SLAVE_BULK_SYNC  Configuration replication finished

21:51:29 CEST Aug 8 2016
SLAVE_BULK_SYNC  SLAVE            Configuration replication finished

```

=====

unit-1-2:*****

```

=====
From State      To State      Reason
=====
21:49:24 CEST Aug 8 2016
DISABLED        DISABLED       Disabled at startup

21:50:16 CEST Aug 8 2016
DISABLED        ELECTION      Enabled from CLI

21:50:17 CEST Aug 8 2016
ELECTION        ONCALL        Received cluster control message

21:50:21 CEST Aug 8 2016
ONCALL          ELECTION      Received cluster control message

21:50:21 CEST Aug 8 2016
ELECTION        ONCALL        Received cluster control message

21:50:26 CEST Aug 8 2016
ONCALL          ELECTION      Received cluster control message

21:50:26 CEST Aug 8 2016
ELECTION        ONCALL        Received cluster control message

```

21:50:31 CEST Aug 8 2016 ONCALL	ELECTION	Received cluster control message
21:50:31 CEST Aug 8 2016 ELECTION	ONCALL	Received cluster control message
21:50:36 CEST Aug 8 2016 ONCALL	ELECTION	Received cluster control message
21:50:36 CEST Aug 8 2016 ELECTION	ONCALL	Received cluster control message
21:50:41 CEST Aug 8 2016 ONCALL	ELECTION	Received cluster control message
21:50:41 CEST Aug 8 2016 ELECTION	ONCALL	Received cluster control message
21:50:46 CEST Aug 8 2016 ONCALL	ELECTION	Received cluster control message
21:50:46 CEST Aug 8 2016 ELECTION	ONCALL	Received cluster control message
21:50:51 CEST Aug 8 2016 ONCALL	ELECTION	Received cluster control message
21:50:51 CEST Aug 8 2016 ELECTION	ONCALL	Received cluster control message
21:50:56 CEST Aug 8 2016 ONCALL	ELECTION	Received cluster control message
21:50:56 CEST Aug 8 2016 ELECTION	ONCALL	Received cluster control message
21:51:01 CEST Aug 8 2016 ONCALL	ELECTION	Received cluster control message
21:51:01 CEST Aug 8 2016 ELECTION	ONCALL	Received cluster control message
21:51:06 CEST Aug 8 2016 ONCALL	ELECTION	Received cluster control message
21:51:06 CEST Aug 8 2016 ELECTION	ONCALL	Received cluster control message
21:51:12 CEST Aug 8 2016 ONCALL	ELECTION	Received cluster control message
21:51:12 CEST Aug 8 2016 ELECTION	ONCALL	Received cluster control message
21:51:17 CEST Aug 8 2016 ONCALL	ELECTION	Received cluster control message
21:51:17 CEST Aug 8 2016 ELECTION	ONCALL	Received cluster control message
21:51:22 CEST Aug 8 2016 ONCALL	ELECTION	Received cluster control message
21:51:22 CEST Aug 8 2016		

```
ELECTION                ONCALL                Received cluster control message
21:51:27 CEST Aug 8 2016
ONCALL                  ELECTION                Received cluster control message
21:51:27 CEST Aug 8 2016
ELECTION                ONCALL                Received cluster control message
21:51:30 CEST Aug 8 2016
ONCALL                  SLAVE_COLD             Received cluster control message
21:51:30 CEST Aug 8 2016
SLAVE_COLD              SLAVE_APP_SYNC         Client progression done
21:51:31 CEST Aug 8 2016
SLAVE_APP_SYNC          SLAVE_CONFIG           Slave application configuration sync done
21:51:43 CEST Aug 8 2016
SLAVE_CONFIG            SLAVE_BULK_SYNC        Configuration replication finished
21:51:55 CEST Aug 8 2016
SLAVE_BULK_SYNC         SLAVE                   Configuration replication finished
```

```
=====
firepower#
```

ةعرسلا قئاف لاسرالا جم انرب ةومجم ليجست 3 ةمهمل (FTD) لى FMC

ةمهمل تابلطتم:

ةومجم ماظن يف اهعيمجتب مق مث FMC لى ةيقطنملا ةزهجال ةفاضاب مق

لحل:

ليجست كىل ع بچي، FMC 6.3 رادصا عم لالحا وه امك. FMC لى ةيقطنم ةزهجا ةفاضاب 1 ةوطخلا تافرع ةيقب فاشتكا متي. (يسيرلا زاهجال وه نوكي ناب ىصوي) طقف دحاو FTD زاهج FMC ةطساوب ايقئال (FTD) جتتملا

قوف رقناو ةزهجال ةرادا بيوبتلا ةمالع >ةزهجال لى لقتناو FMC لى لوخذلا ليجستب مق زاهج ةفاضاب

ةروصلال يف ةروكذملا تادادعلا مادختساب لوالا يقطنملا زاهجال ةفاضاب مق

ليجستلا ادبل ليجستلا قوف رقنا

Add Device ? X

Host: 10.62.148.67

Display Name: FTD1

Registration Key: cisco

Group: None

Access Control Policy: FTD9300

Smart Licensing

Malware:

Threat:

URL Filtering:

Advanced

i On version 5.4 devices or earlier, the licensing options will need to be specified from [licensing page](#).

Register Cancel

ةروصلال ي ف حضورم وه امك ققحتال متي

FTD_cluster		Cisco Firepower 9000 Series SM-36 Threat Defense Cluster		
<input checked="" type="checkbox"/>	FTD1(primary)	10.62.148.67 - Cisco Firepower 9000 Series SM-36 Threat Defense - v6.0.1 - routed	Cisco Firepower 9000 Series SM-36 Thre Base, Threat, Malware, URL Filtering	FTD9300
<input checked="" type="checkbox"/>	FTD2	10.62.148.68 - Cisco Firepower 9000 Series SM-36 Threat Defense - v6.0.1 - routed	Cisco Firepower 9000 Series SM-36 Thre Base, Threat, Malware, URL Filtering	FTD9300
<input checked="" type="checkbox"/>	FTD3	10.62.148.69 - Cisco Firepower 9000 Series SM-36 Threat Defense - v6.0.1 - routed	Cisco Firepower 9000 Series SM-36 Thre Base, Threat, Malware, URL Filtering	FTD9300

FMC ىلع ذفنملا ةانقلل ةي عرفلا تاهاولا نيوكت 4. ةمهمل

ةمهمل تابلطتم

ذفنملا ةانق تانايب ةهاول ةي عرفلا تاهاولا نيوكت ب مق

لحل:

الحوطخل FTD_Cluster Edit رز دح، FMC ةي موسرلا مدختسملا ةهاولا نم 1. ةوطخل

حضورم وه امك >تاهاول ةفاضل ةي عرفلا ةهاولا ىلع رقنوا تاهاولا بيوبتلا ةمالع ىل لقتنا ةروصلال ي ف

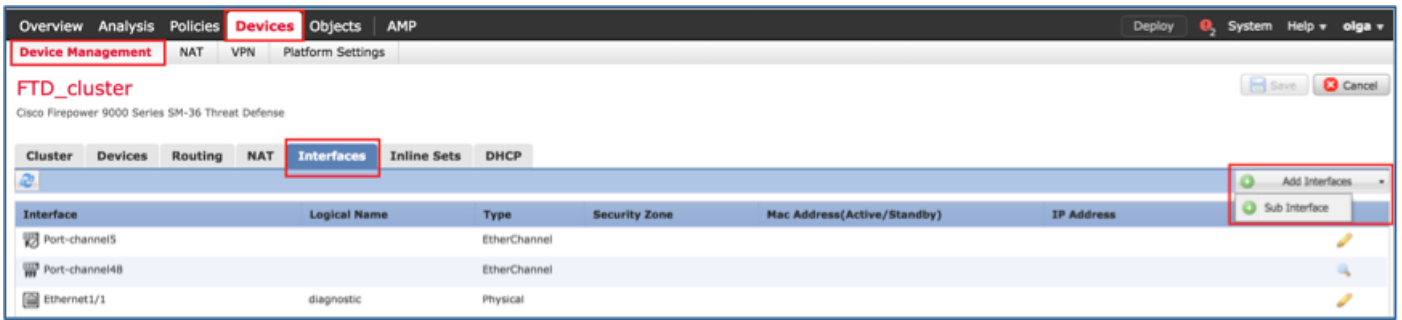

قېبطل قفاوم دح. لېصافتال هذه مادختساب لولأال ةيعرفال ةهجالول نيوكتب مق روصال يف حضوم وه امك و تاريغتال

مسالا	لخاد
ةماعال بېوبتال ةماع	Port-channel5
ةهجالول	201
ةيعرفال ةهجالول فرع	201
VLAN ID	201
ةماع IPv4	
وع IP	تباتال IP مادختسا
انوع IP	192.168.75.10/24

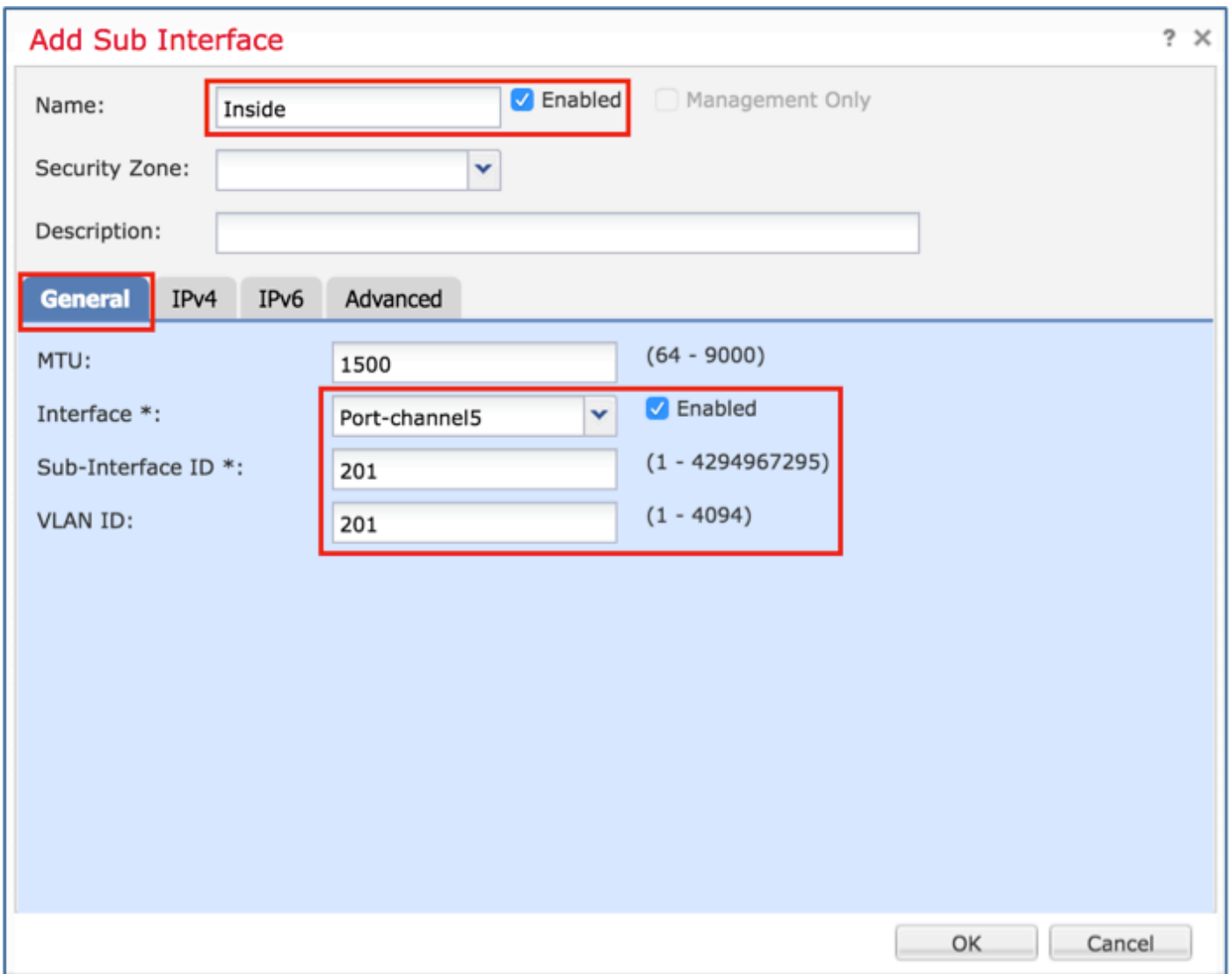

Add Sub Interface ? X

Name: Enabled Management Only

Security Zone: ▼

Description:

General **IPv4** IPv6 Advanced

IP Type: ▼

IP Address: eg. 1.1.1.1/255.255.255.228 or 1.1.1.1/25

OK Cancel

ليصاف التل هذه مادختساب ةي ناثال ةي عرفال ةه جاولا نيوك تب مق.

مسالا	جراخ
ةماعال بيوبتال ةماع	Port-channel5
ةه جاولا	210
ةي عرفال ةه جاولا فرعم	210
VLAN ID	210
IPv4 بيوبت ةماع	تباتال IP مادختسا
عون IP	192.168.76.10/24
عوناون IP	

يلع تاريخيغتلارشن م ث **ظفح** قوف رونا . ةي عرفال ةه جاولا عاشنإل **قفاوم** قوف رونا
ةروصلال يف حضوم وه امك FTD_CLUSTER

ققحتال:

Interface	Logical Name	Type	Security Zone	Mac Address(Active/Standby)	IP Address
Port-channel5		EtherChannel			
Port-channel48		EtherChannel			
Ethernet1/1	diagnostic	Physical			
Port-channel5.201	Inside	SubInterface			192.168.75.10/24(Static)
Port-channel5.210	Outside	SubInterface			192.168.76.10/24(Static)

يساس الالاصتالال نم ققحتالال 5 ةمهملال

ةمهملال تابلطتم:

VM. يزاهج نيب لالاصتالال نم ققحتو طاقتلال عاشناب مق

للحال:

ةومجممال ماظن تادحو لك ىلع طاقتلال عاشناب 1 ةوطخلال

تاهجالول طاقتلال عاشناب مقو ةيسىئرلال ةدحو لل (ASA) LINA ب صاخلال CLI ىل لقتنالا ةجراخلال او ةيلخالال

```

firepower#
firepower# cluster exec capture capi interface inside match icmp any any
unit-1-1 (LOCAL): *****

unit-1-3:*****

unit-1-2:*****
firepower#
firepower# cluster exec capture capo interface outside match icmp any any
unit-1-1 (LOCAL): *****

unit-1-3:*****

unit-1-2:*****
firepower#
ققحتالال:

firepower# cluster exec show capture
unit-1-1 (LOCAL): *****
capture capi type raw-data interface Inside [Capturing - 0 bytes]
  match icmp any any
capture capo type raw-data interface Outside [Capturing - 0 bytes]
  match icmp any any

unit-1-3:*****
capture capi type raw-data interface Inside [Capturing - 0 bytes]

```

```
match icmp any any
capture capo type raw-data interface Outside [Capturing - 0 bytes]
match icmp any any
```

```
unit-1-2:*****
capture capi type raw-data interface Inside [Capturing - 0 bytes]
match icmp any any
capture capo type raw-data interface Outside [Capturing - 0 bytes]
match icmp any any
firepower#
```

VM2 إلى VM1 نم لاصتال را بتخا| ارجاب مق 2. ةوطخال

رابتخال ا دع ب طاقتل الال جرخ نم ققحت . مزح 4 عم رابتخال اب مق

```
firepower# cluster exec show capture
unit-1-1(LOCAL):*****
capture capi type raw-data interface Inside [Capturing - 0 bytes]
match icmp any any
capture capo type raw-data interface Outside [Capturing - 0 bytes]
match icmp any any
```

```
unit-1-3:*****
capture capi type raw-data interface Inside [Capturing - 752 bytes]
match icmp any any
capture capo type raw-data interface Outside [Capturing - 752 bytes]
match icmp any any
```

```
unit-1-2:*****
capture capi type raw-data interface Inside [Capturing - 0 bytes]
match icmp any any
capture capo type raw-data interface Outside [Capturing - 0 bytes]
match icmp any any
firepower#
```

ةدحولا ةدحولا ال ع طاقتل الال جرخا| نم ققحتلل رمأل لايغش تب مق

```
firepower# cluster exec unit unit-1-3 show capture capi
```

8 packets captured

```
1: 12:58:36.162253      802.1Q vlan#201 P0 192.168.75.100 > 192.168.76.100: icmp: echo
request
2: 12:58:36.162955      802.1Q vlan#201 P0 192.168.76.100 > 192.168.75.100: icmp: echo reply
3: 12:58:37.173834      802.1Q vlan#201 P0 192.168.75.100 > 192.168.76.100: icmp: echo
request
4: 12:58:37.174368      802.1Q vlan#201 P0 192.168.76.100 > 192.168.75.100: icmp: echo reply
5: 12:58:38.187642      802.1Q vlan#201 P0 192.168.75.100 > 192.168.76.100: icmp: echo
request
6: 12:58:38.188115      802.1Q vlan#201 P0 192.168.76.100 > 192.168.75.100: icmp: echo reply
7: 12:58:39.201832      802.1Q vlan#201 P0 192.168.75.100 > 192.168.76.100: icmp: echo
request
8: 12:58:39.202321      802.1Q vlan#201 P0 192.168.76.100 > 192.168.75.100: icmp: echo reply
8 packets shown
```

```
firepower# cluster exec unit unit-1-3 show capture capo
```

8 packets captured

```

1: 12:58:36.162543      802.1Q vlan#210 P0 192.168.75.100 > 192.168.76.100: icmp: echo
request
2: 12:58:36.162894      802.1Q vlan#210 P0 192.168.76.100 > 192.168.75.100: icmp: echo reply
3: 12:58:37.174002      802.1Q vlan#210 P0 192.168.75.100 > 192.168.76.100: icmp: echo
request
4: 12:58:37.174307      802.1Q vlan#210 P0 192.168.76.100 > 192.168.75.100: icmp: echo reply
5: 12:58:38.187764      802.1Q vlan#210 P0 192.168.75.100 > 192.168.76.100: icmp: echo
request
6: 12:58:38.188085      802.1Q vlan#210 P0 192.168.76.100 > 192.168.75.100: icmp: echo reply
7: 12:58:39.201954      802.1Q vlan#210 P0 192.168.75.100 > 192.168.76.100: icmp: echo
request
8: 12:58:39.202290      802.1Q vlan#210 P0 192.168.76.100 > 192.168.75.100: icmp: echo reply
8 packets shown
firepower#

```

يالات الرمال مادخت ساب طاق لال الفحا، ةمهم ال هذه نم يهتنت نأ دعب:

```

firepower# cluster exec no capture capi
unit-1-1 (LOCAL): *****

unit-1-3: *****

unit-1-2: *****

```

```

firepower# cluster exec no capture capo
unit-1-1 (LOCAL): *****

unit-1-3: *****

unit-1-2: *****

```

VM1 إلى VM2 نم فلم لي زنت 3. ةوطخل

FTP لي معك VM2، FTP مداخلك اق بس م VM1 ني وكت مت

ي لي ام مادخت ساب ةديج تاطقل عاشن:

```

firepower# cluster exec capture capi interface inside match ip host 192.168.75.100 host
192.168.76.100
unit-1-1 (LOCAL): *****

unit-1-3: *****

unit-1-2: *****

```

```

firepower# cluster exec capture capo interface outside match ip host 192.168.775.100 host
192.168.76.100
unit-1-1 (LOCAL): *****

unit-1-3: *****

unit-1-2: *****

```

FTP لي مع مادخت ساب، VM1 إلى VM2 نم فلم لي زنت ب مق

show conn: جارخا نم ققحت

```
firepower# cluster exec show conn all
unit-1-1(LOCAL):*****
20 in use, 21 most used
Cluster:
fwd connections: 0 in use, 2 most used
dir connections: 0 in use, 52 most used
centralized connections: 0 in use, 6 most used

TCP Outside 192.168.76.100:49175 Inside 192.168.75.100:21, idle 0:00:32, bytes 665, flags UIOeN
UDP cluster 255.255.255.255:49495 NP Identity Ifc 127.2.1.1:49495, idle 0:00:00, bytes 17858058, flags -
TCP cluster 127.2.1.3:10844 NP Identity Ifc 127.2.1.1:38296, idle 0:00:33, bytes 5496, flags UI
.....
TCP cluster 127.2.1.3:59588 NP Identity Ifc 127.2.1.1:10850, idle 0:00:33, bytes 132, flags UO

unit-1-3:*****
12 in use, 16 most used
Cluster:
fwd connections: 0 in use, 4 most used
dir connections: 1 in use, 10 most used
centralized connections: 0 in use, 0 most used

TCP Outside 192.168.76.100:49175 Inside 192.168.75.100:21, idle 0:00:34, bytes 0, flags y
TCP cluster 127.2.1.1:10851 NP Identity Ifc 127.2.1.3:48493, idle 0:00:52, bytes 224, flags UI
.....
TCP cluster 127.2.1.1:64070 NP Identity Ifc 127.2.1.3:10847, idle 0:00:11, bytes 806, flags UO

unit-1-2:*****
12 in use, 15 most used
Cluster:
fwd connections: 0 in use, 2 most used
dir connections: 0 in use, 3 most used
centralized connections: 0 in use, 0 most used

TCP cluster 127.2.1.1:10851 NP Identity Ifc 127.2.1.2:64136, idle 0:00:53, bytes 224, flags UI
.....
TCP cluster 127.2.1.1:15859 NP Identity Ifc 127.2.1.2:10847, idle 0:00:11, bytes 807, flags UO
```

show capture output:

```
firepower# cluster exec show cap
unit-1-1(LOCAL):*****
capture capi type raw-data interface Inside [Buffer Full - 523954 bytes]
  match ip host 192.168.75.100 host 192.168.76.100
capture capo type raw-data interface Outside [Buffer Full - 524028 bytes]
  match ip host 192.168.75.100 host 192.168.76.100

unit-1-3:*****
capture capi type raw-data interface Inside [Buffer Full - 524062 bytes]
  match ip host 192.168.75.100 host 192.168.76.100
capture capo type raw-data interface Outside [Buffer Full - 524228 bytes]
  match ip host 192.168.75.100 host 192.168.76.100
```

```
unit-1-2:*****
capture capi type raw-data interface Inside [Capturing - 0 bytes]
  match ip host 192.168.75.100 host 192.168.76.100
capture capo type raw-data interface Outside [Capturing - 0 bytes]
  match ip host 192.168.75.100 host 192.168.76.100
```

Chassis Manager مداخل و مخرج ماطن طاق

تاذ تاوونق 2 عم FPR9300 ىلع تادحو 3 نم ةنوكم ةعومجم ةدهاشم كنكمي ،ةيالاتا ةروصلال ي ف موهفملا سفن نوكييس FTD ةلاحي ف نكلو ،ASA يه ةيقتنملا ةزهجالا (8 و 48) نيذفم رظن ةهجو نمف ،ةعومجم ماطن تادحو 3 دوجو نم مغلرلا ىلع هنا وه هركذت بجي يذلا مهملا ءيشلاو دحاو يقتنم زايج ىوس دجوي ال لاقتعالا

The screenshot displays the 'Logical Device List' in the Chassis Manager. It shows three clustered ASA security modules, each with detailed configuration and status information.

Security Module	Application	Version	Management IP	Gateway	Management Port	Status
Security Module 1	ASA	9.6.2.7	0.0.0.0	0.0.0.0	Ethernet1/1	online
Ports:		Attributes:				
Data Interfaces:	Port-channel8	Cluster Operational Status : in-cluster				
Cluster Interfaces:	Port-channel48	Management IP VIRTUAL : 10.111.8.206				
		Cluster Role : master				
		Management URL : https://10.111.8.206/				
		Management IP : 10.111.8.193				
Security Module 2	ASA	9.6.2.7	0.0.0.0	0.0.0.0	Ethernet1/1	online
Ports:		Attributes:				
Data Interfaces:	Port-channel8	Cluster Operational Status : in-cluster				
Cluster Interfaces:	Port-channel48	Management IP VIRTUAL : 10.111.8.206				
		Cluster Role : slave				
		Management URL : https://10.111.8.206/				
		Management IP : 10.111.8.189				
Security Module 3	ASA	9.6.2.7	0.0.0.0	0.0.0.0	Ethernet1/1	online
Ports:		Attributes:				
Data Interfaces:	Port-channel8	Cluster Operational Status : in-cluster				
Cluster Interfaces:	Port-channel48	Management IP VIRTUAL : 10.111.8.206				
		Cluster Role : slave				
		Management URL : https://10.111.8.206/				
		Management IP : 10.111.8.190				

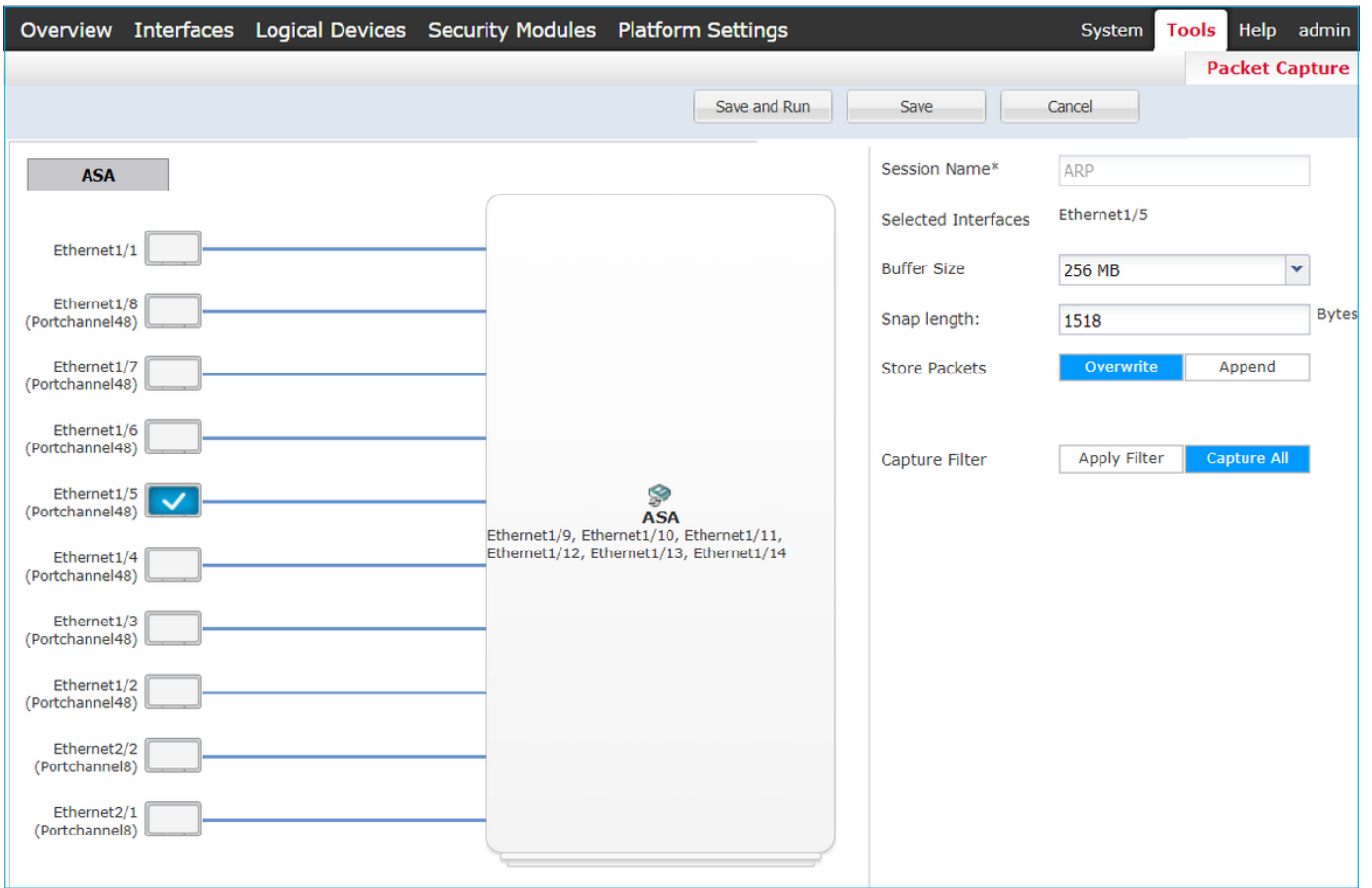

ةوعومجملا ماظن نم عبات زاغ فذح .6 ةمهمل

ةمهمل تابلطتم:

ةوعومجملا ماظن نم Slave ةدحو فذحو او FMC ىلى لوخدلا ليجستب مق

لحل:

> زاغلا ىلى لقتناو (FMC) تاراطالا ةرادا يف مكحتلا ةدحو ىلى لوخدلا ليجستب مق .1 ةوطخلا ةزهال ةرادا

ةروصلا يف حضوم وه امك ديبعلا ةدحو راوجب ةدووملا ةمامقلا ةنوقي رقنا

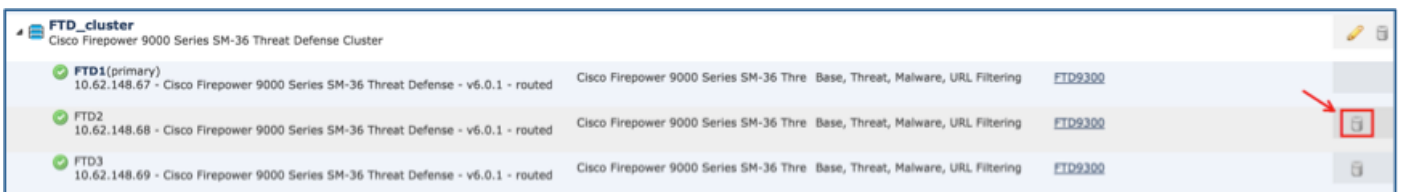

ةروصلا يف حضوم وه امك ديكأتل معن دح .ديكأتل ةذفان رهظت



قحتل:

- ةروصلل ي ف حضوم وه امك FMC نم .



- لئغشتللا ماطنل (CLI) رملأال رطس ةهءاو نم .

```
FPR9K-1-A# scope ssa
FPR9K-1-A /ssa # show app-instance
```

Application Name	Slot ID	Admin State	Operational State	Running Version	Startup
ftd	1	Enabled	Online	6.0.1.1213	6.0.1.1213
In Cluster					
ftd	2	Enabled	Online	6.0.1.1213	6.0.1.1213
In Cluster					
ftd	3	Enabled	Online	6.0.1.1213	6.0.1.1213
In Cluster					

- نم CLI (ASA) LINA.

```
firepower# show cluster info
Cluster FTD_cluster: On
Interface mode: spanned
This is "unit-1-1" in state MASTER
ID          : 0
Version    : 9.6(1)
Serial No.: FLM19216KK6
CCL IP     : 127.2.1.1
CCL MAC    : 0015.c500.016f
Last join  : 21:51:03 CEST Aug 8 2016
Last leave : N/A

Other members in the cluster:
Unit "unit-1-3" in state SLAVE
ID          : 1
Version    : 9.6(1)
Serial No.: FLM19206H7T
CCL IP     : 127.2.1.3
CCL MAC    : 0015.c500.018f
Last join  : 21:51:05 CEST Aug 8 2016
Last leave : N/A

Unit "unit-1-2" in state SLAVE
ID          : 2
Version    : 9.6(1)
Serial No.: FLM19206H71
CCL IP     : 127.2.1.2
CCL MAC    : 0015.c500.019f
```

Last join : 21:51:30 CEST Aug 8 2016

Last leave: N/A

firepower#

يف ةومجم ل ماظن يف اوضع لازي ال هنكلو FMC نم زاهجلا ليجست متي مل :ةظحالم
FPR9300.

ةحصلا نم ققحتلا

ححص لكش ب نيوكتلا لمع ديكأتل مسقلا اذه مدختسا

ةدح ىلع ةمه لك ةيطغتو ققحتلا لامكإ متي

اهحالصإو ءاطخألا فاشكتسا

نيوكتلا اذهل اهلصإو ءاطخألا فاشكتسالا ةدحم تامولعم أيلاح رفوتت ال

ةلص تاذا تامولعم

• انه Cisco Firepower Management Center نيوكت ليلد تارادصإ عيجم ىلع روثلعل نكمي :
https://www.cisco.com/c/en/us/td/docs/security/firepower/roadmap/firepower-roadmap.html#id_47280.

• انه رماوألا رطس ةهجاو نيوكت ةلدأو FXOS لكه ريديم تارادصإ عيجم ىلع روثلعل نكمي :
<https://www.cisco.com/c/en/us/td/docs/security/firepower/fxos/roadmap/fxos-roadmap.html#pgfld-121950>.

• ئيرملا ليلدل اذهب ةدشب Cisco نم (TAC) يملال ةينقتلا ةدعاسملا زكرم يصوي
امب ، Cisco Firepower نم يلاتلا ليجلا نامأ تاي نقت لوح ةقمعتملا ةيلمعلا ةفرعملل
ةلاقملا هذه يف ةروكذملا تاي نقتلا لكذيف :
<http://www.ciscopress.com/title/9781587144806>.

• تاي نقتب ةقلعتملا ةينقتلا تاطحالمل ءاطخأ فاشكتساو ةئيهتلا تاي لمع ةفاكل
اهحالصإو FirePOWER .
<https://www.cisco.com/c/en/us/support/security/defense-center/tsd-products-support-series-home.html>.

• [Cisco Systems - تادنتسمل او ي نقتلا معدلا](#)

ةمچرتل هذه لوج

ةللأل تاي نقتل نم ةومچم مادختساب دن تسمل اذه Cisco تچرت
ملاعلاء انءمچ يف نيمدختسمل معدى وتحم مي دقتل ةيرشبلاو
امك ةقيد نوك تنل ةللأل ةمچرت لصف أن ةظحال مچرئ. ةصاغل مهتغب
Cisco يلخت. فرتحم مچرت مامدقي يتل ةيفارتحال ةمچرتل عم لالحل وه
ىلإ أمئاد ةوچرلاب يصوت وتامچرتل هذه ةقد نع اهتيلوئسم Cisco
Systems (رفوتم طبارلا) يلصلأل يزيلچنلإل دن تسمل